

# HG

## MAGNETIC CONTACTORS & OVERLOAD RELAYS

<b>Overview and Characteristics</b>		4
<b>Technical Data</b>	External Structure	6
	Internal Structure	8
	Technical Data	10
<b>Model Selection Table</b>	Model Selection Table	32
	Ratings and Order Code	36
<b>Accessories</b>		62
<b>Dimensions</b>		71
<b>Circuit Diagram</b>		87
<b>Order Code</b>		88
<b>Handling and Maintenance Inspection</b>		92
<b>Acquired Standards</b>		95

## HG Series

# Magnetic Contactors & Overload Relays

Motor protection control solution that can be applied to various industrial equipment with strong durability and enhanced insulation performance!



## Reduced Installation Area with upper Auxiliary Contact Structure

In the installation area for 10 units previously, 4 additional units can be installed with HG MC!

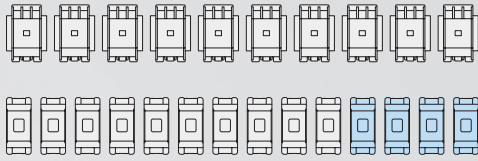

## Various Product Ranges

18 AF ~ 800 AF (8 Frames)

## Rated Insulation Voltage (Ui)

HGC 50 A ~ 800 A

## Direct Connection with Overload Relay

HGT 18 AF ~ 800 AF

## Auxiliary Relay – Power Consumption Power Saving Type

HGC DC : Permanent Magnet Applied

## TOR Safety Protection Cover and Separated Test, Reset Buttons

Removable cover has been applied for safety.

## AC/DC Free Voltage

HGC 115 A ~ 800 A

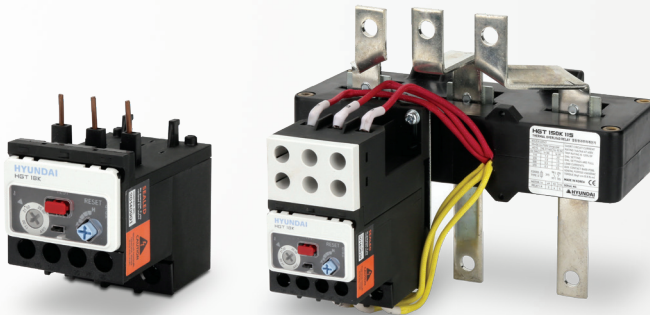

## Overview and Characteristics

### Product Characteristics

- Magnetic contactor is usually used for motor and equipment operation control and is applied to MCC and Thermal and Hydro power Panel.
- Hyundai provides a wide range of 9 A ~ 800 A of magnetic contactors and thermal/magnetic overload relays.



#### User Convenience

- User-Centered Design
- Compact Product and Convenient Wiring/Compatibility



#### Product Design

- Modular, Compact Design
- 30 % Compact Compared to the Previous Model



#### Technical Characteristics

- Optimized Structure
- IEC Standard



#### Product Reliability

- Quality Stabilization
- Specialized Design and Product Structure



### User Convenience

- Up/down allocation of coil terminal
- Built-in auxiliary contact
  - HGC9 ~ HGC40 : 1a1b or 2a2b
  - HGC50 ~ HGC100 : 2a2b

### Product Design

- Reduced installation area with upper auxiliary contact structure
  - Space for 10 units of UMC65 (Based on 2a2b)
  - 14 units of HGC65 can be mounted

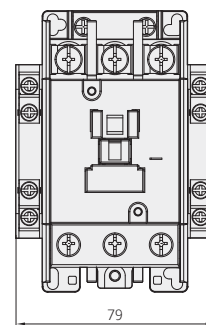
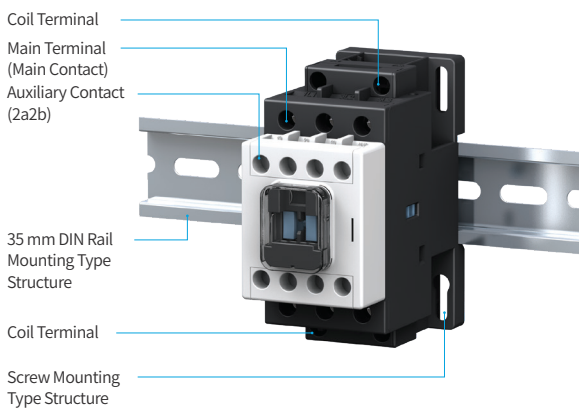

UMC65AF

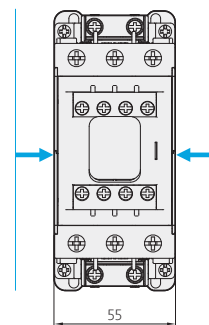

HGC65AF



## Technical Characteristics

- IEC60947-4-1 (2012) applied
- CB/CCC/Classification Certificate (7) acquired



## Product Reliability

Enhanced reliability and stability with Type 2 Coordination-based design

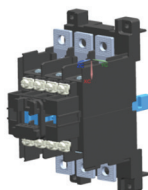

Enclosed Arc Extinguish Chamber

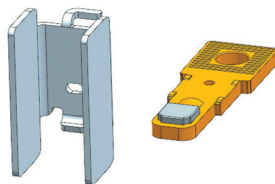

Device for Prevention of Melting Contact  
- Arc Horn Structure Applied

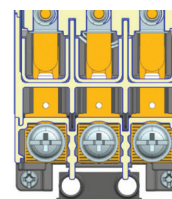

Dual Exhaust Structure  
- Indirect Arc Discharge

### Refer to Option

Item	Details
No Coordination Concept	<p><b>Significant levels of risk</b></p> <p>Incompatible with standard specifications</p> <ul style="list-style-type: none"> <li>• NF C 15-100 and IEC 60364-1, Clause 133-1 (Installation Regulation)</li> <li>• EN/IEC 60204-1, Clause 7 (Electrical Device used in Machinery)</li> <li>• IEC 60947-4-1, Clause 8, 2, 5 (Starter)</li> </ul>
Type 1 Coordination	<p><b>This is the method that is mostly used in general.</b></p> <ul style="list-style-type: none"> <li>• Low device cost</li> <li>• In case reliability for the operation and maintenance is not compulsory,</li> <li>• the starter may have to be repaired before re-operating the motor.</li> </ul> <p>Result : • The equipment's operating time may be quite long • Skilled personnel are required for inspection, repair, parts and others</p> <p>Application example : Air-conditioning device in commercial buildings</p>
Type 2 Coordination	<p><b>Reliability for operation and maintenance can be secured.</b></p> <p>Result : • Reduction of equipment's operating time • Shorten response time for short-circuit accidents</p> <p>Application example : Escalators</p>
Total Coordination	<p><b>No damage at all, no problems caused by operation mistake, reliability of operation maintenance is secured.</b></p> <p>Result : • Immediate return to operation • No special precautions are required.</p> <p>Application example : Smoke exhaust device, fire-fighting pump</p>

# Technical Data

## External Structure (Magnetic Contactor)

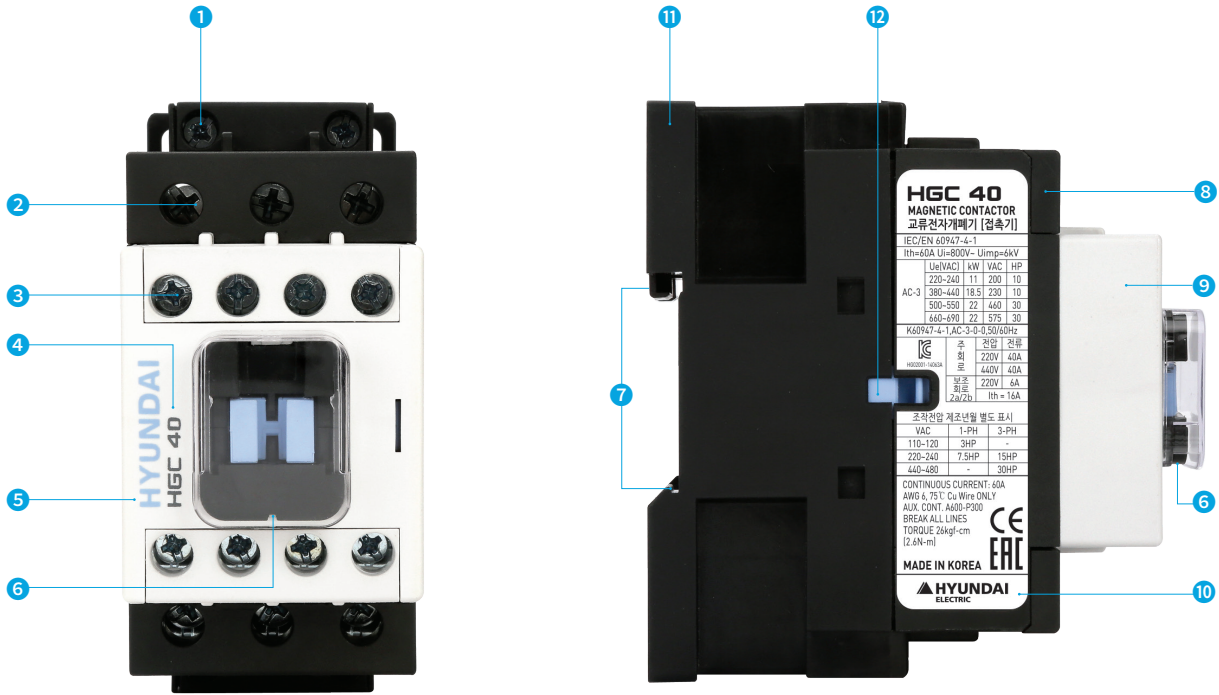

- 1 Control Power Terminal
- 2 Main Terminal
- 3 Auxiliary Terminal
- 4 Product Name
- 5 Manufacturer
- 6 Safety Cover
- 7 Din-Rail Mounting Part
- 8 Upper Frame
- 9 Upper Cover
- 10 Nameplate
- 11 Screw Mounting Hole
- 12 Mounting Hole for Auxiliary Devices

Product Name: **HGC 40 MAGNETIC CONTACTOR**  
교류전자개폐기 [접속기]

Rating Specification: IEC/EN 60947-4-1, Ith=60A Ui=800V - Uimp=6kV

Ue[VAC]	kW	VAC	HP
220-240	11	200	10
380-440	18.5	230	10
500-550	22	460	30
660-690	22	575	30

Certification Mark and Certification Number: K60947-4-1, AC-3-0-0, 50/60Hz

주 회 른	전압	전류
220V	40A	
440V	40A	
220V	6A	
2a/2b	Ith = 16A	

Applied and Reference Standards: CE, EAC

UL Rating: CONTINUOUS CURRENT: 60A AWG 6, 75°C Cu Wire ONLY AUX. CONT. A600-P300 BREAK ALL LINES TORQUE 26kgf-cm (2.6N-m)

Country of Manufacture: **MADE IN KOREA**

HE Logo: **HYUNDAI ELECTRIC** Manufacturer

## External Structure (Thermal Overload Relay)

### Protection Cover

- The front of the operating mechanism is protected by a transparent cover so that the set current value and the reset operation method cannot be manipulated by object.
- To change the setting, lift the transparent cover.

### Test Button

- Pressing the test button during emergency stop during motor operation will open the contact with the magnetic contactor and stop the motor.
- When testing the contact operation of the thermal overload relay, if the test button is pulled up, the contact switching is made so that rapid test is possible.

### Current Setting Knob

The rated current setting can be set in 3 stages by using the +/-screw driver.

### Reset Button

- A (Auto) Mode : Auto Reset
- H (Manual) Mode : Manual Reset

### Main Circuit Terminal

Screw type of terminal is the standard model.

### Safety Reinforcement of TOR

- Attachment of protection cover
  - Prevents operation by user negligence
  - Prevents test function during operation
- Separation of reset button and test button
  - Prevents malfunction

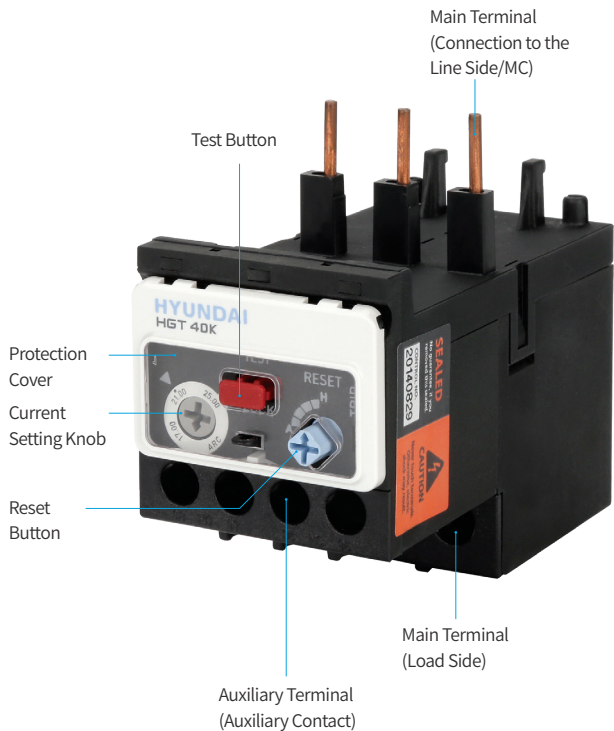

## Technical Data

### Internal Structure

Magnetic Contactor [9 ~ 100 AF]

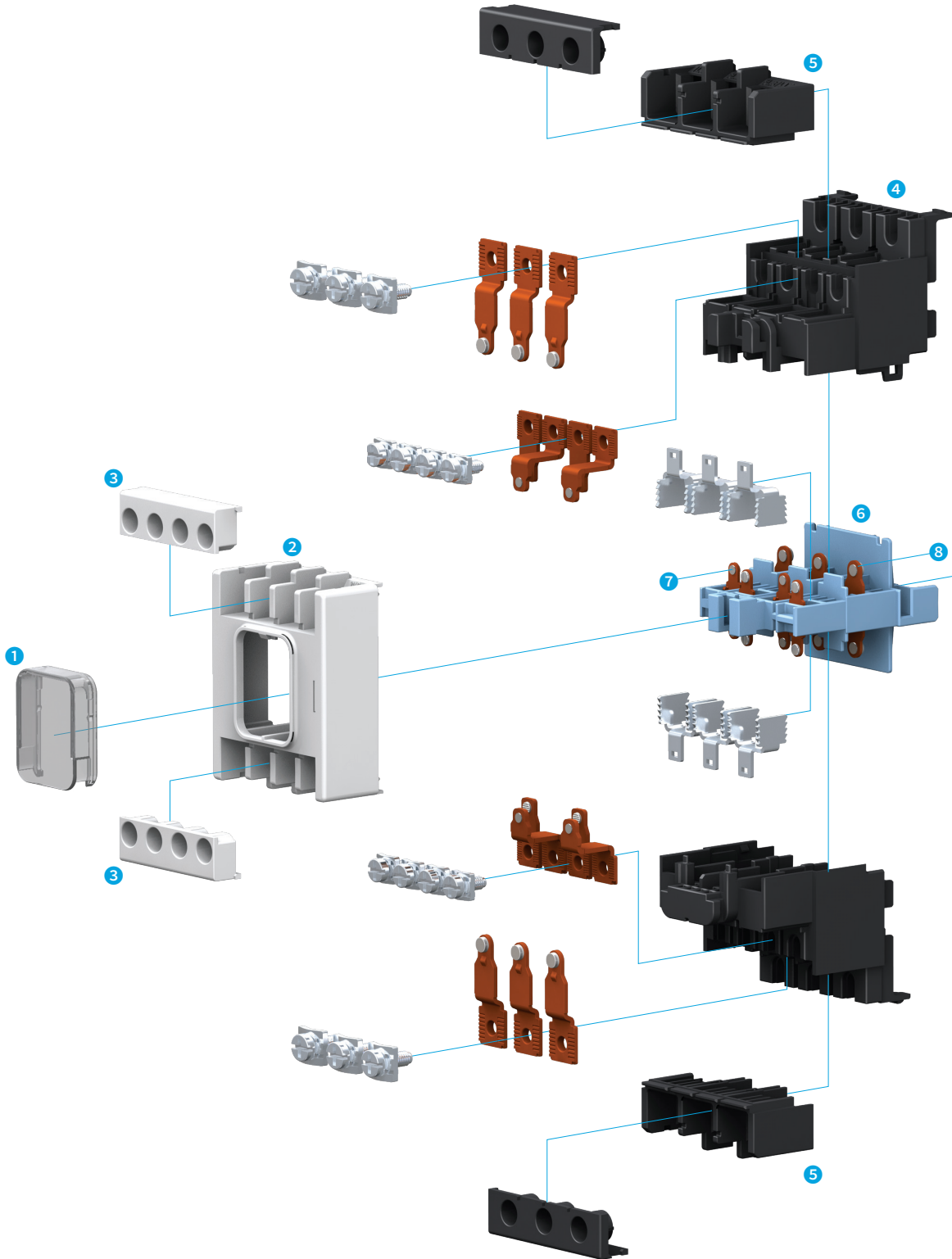

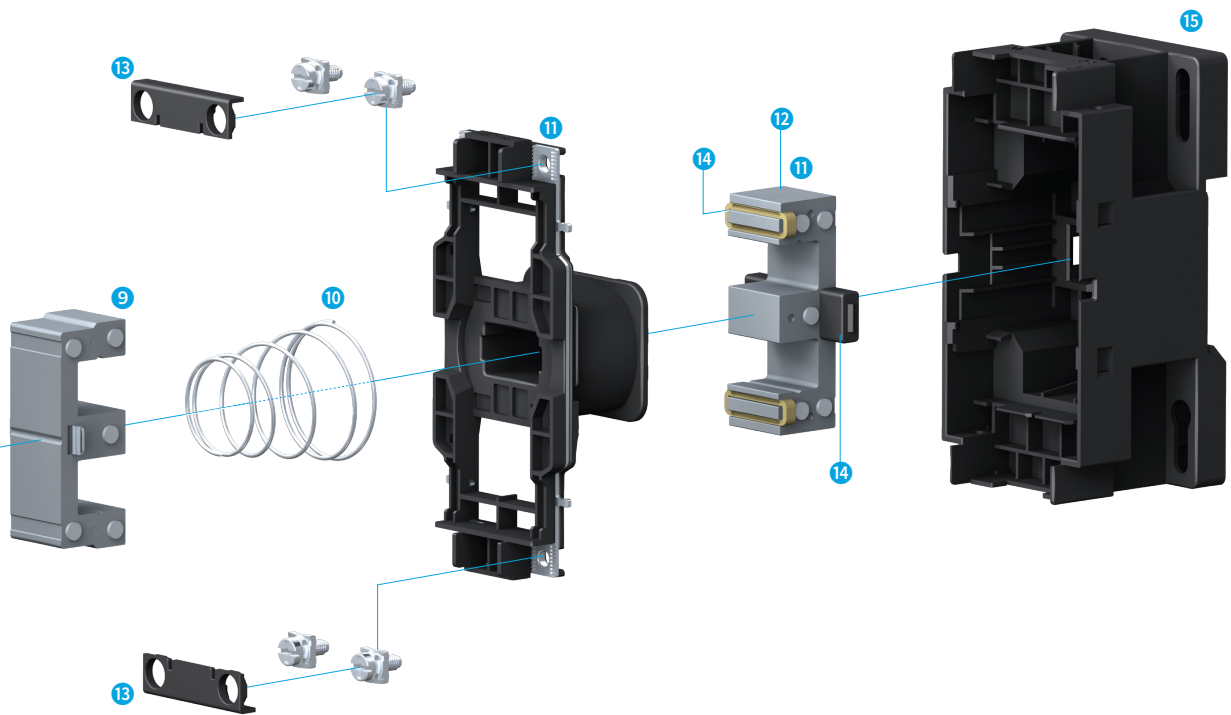

- 1 Safety Cover : Safety cover that prevents the contact bridge from being pressed arbitrarily
- 2 Top Cover : Assembles arc chamber, auxiliary contact part is built in
- 3 Aux. Protection Cover : Safety cover to protect the user from auxiliary contact parts
- 4 Arc Chamber : Arc extinguishing device to prevent On/Off Arc
- 5 Screw Terminal : Device for mounting terminals
- 6 Contact Bridge : Assembled to a moving core and moving contact, it engages in on/off operation and the accessory mounting hole is built in
- 7 Aux. Contact : Operational part of the auxiliary contact terminal
- 8 Moving Contact : Operational part of the main contact terminal
- 9 Moving Core : When power is supplied to the coil, the moving core slides into the fixed core and the magnetic contact is closed
- 10 Return Spring : When the coil is de-energized, it separates the moving core from the fixed core
- 11 Coil Ass'y : The current flowing part to make the fixed core magnetized by supplying power
- 12 Fixed Core : The component that becomes magnetized when the power is supplied to the coil
- 13 Coil Protection Cover : Safety cover to protect the user from the current flowing part of the coil terminal
- 14 Rubber Damper : Device that absorbs the On/Off impact of the magnetic contact
- 15 Frame : Lower part of the magnetic contact built with the coil and fixed core

## Technical Data

### Magnetic Contactor [9 ~ 100 AF]

#### Enhanced Safety

##### Front Protection Cover

- Minimize the input of foreign substance
- Prevent malfunction caused by user's mistake

##### Enclosed Structure of Mounting Hole for Accessories

- Contact bridge creates sealed structure when MC is on/off

##### Removable Protection Cover

- For main terminal, auxiliary terminal, coil terminal
- Protection degree, IP20

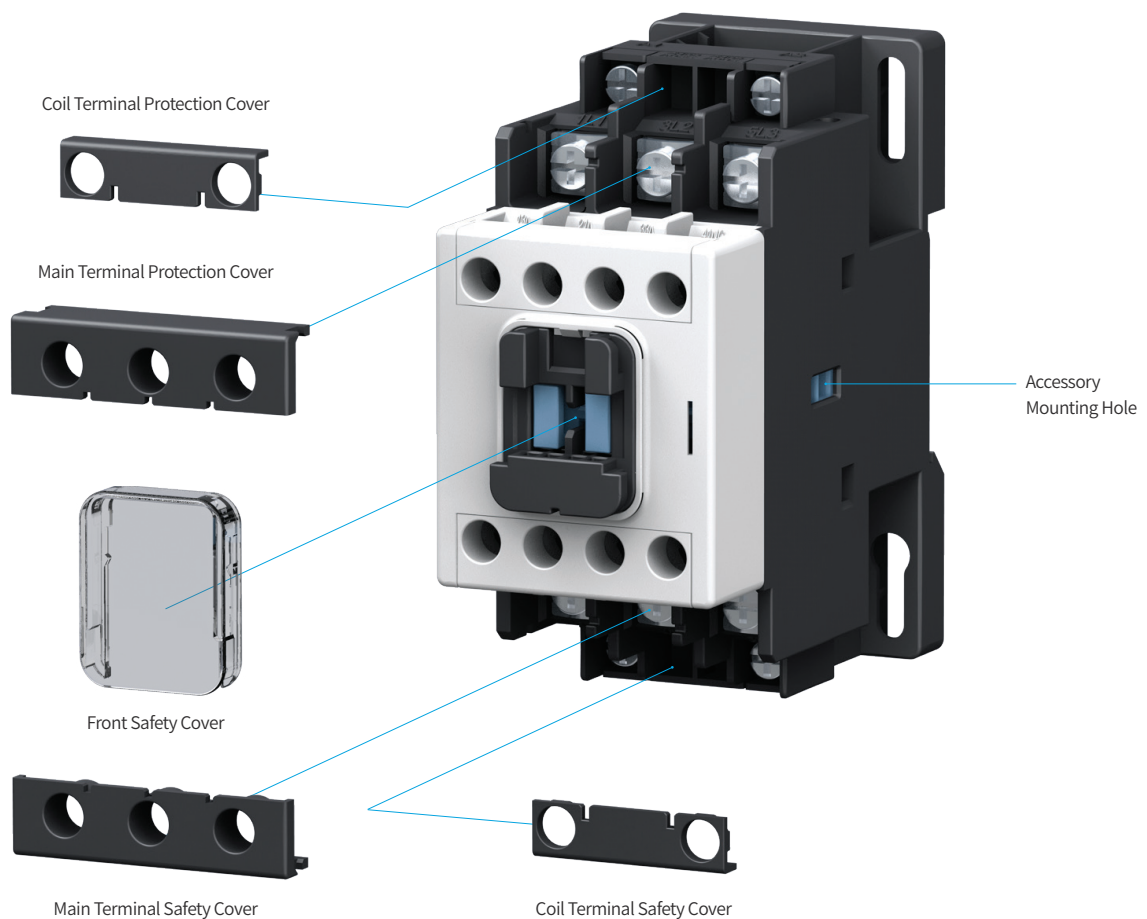



**Improved Customer Convenience**

**Built-In Upper Arrayed Auxiliary Contact**

- 2a2b standard built-in type easy wiring control circuit

**Easy Coil Replacement Structure**

- Easy separation and replacement when it is attached to the panel

**Various Mounting Methods**

- Can be installed in Din Rail and Screw

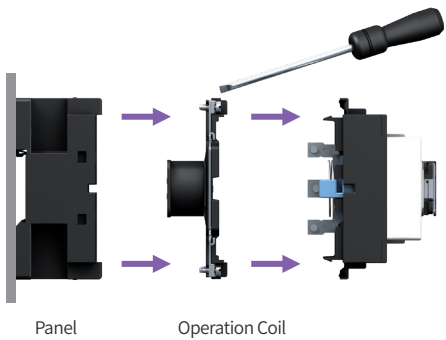
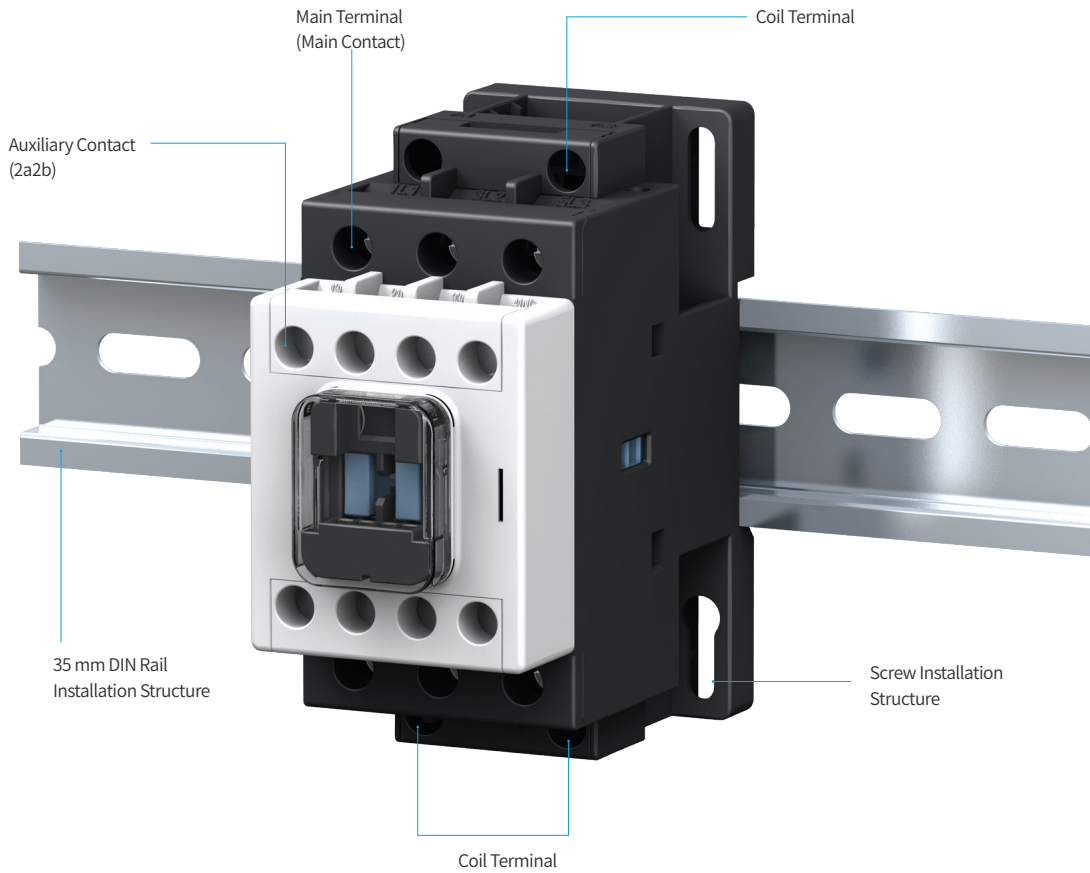

## Technical Data

### Magnetic Contactor [115 ~ 800 AF]

#### Convenient Replacement of Operational Coil

- Easy separation and replacement of operational coil when it is attached to the panel
- The method of fixing the coil unit using a plastic case
  - Minimize the movement of the coil unit

#### Designed to Reduce Noise

- DC excitation method using magnetic circuit

#### Free Voltage of Coil Operation Power

Nominal Voltage	Rated Voltage (AC/DC)
24 V	AC : 24 ~ 26 V, DC : 24 V
48 V	AC : 44 ~ 52 V, DC : 48 V
220 V	AC : 100 ~ 240 V, DC : 110 ~ 220 V
440 V	AC : 380 ~ 450 V

※ Based on HGC115 ~ 265

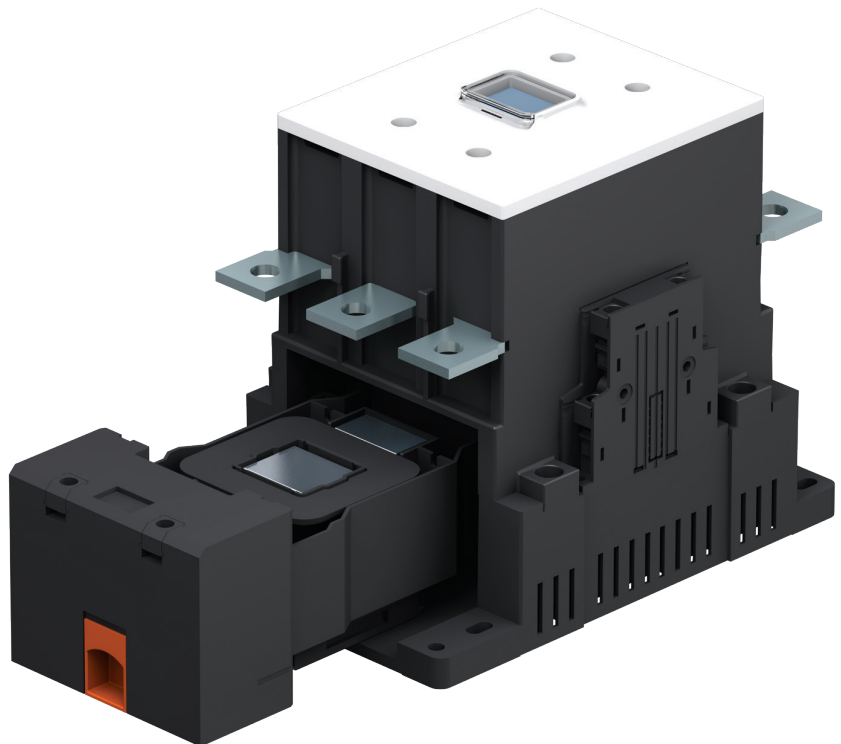

### Easy Maintenance and Replacement for Main Contacts

- When the upper cover is removed, the main contact parts are revealed, enabling easy inspection and replacement of them from outside.

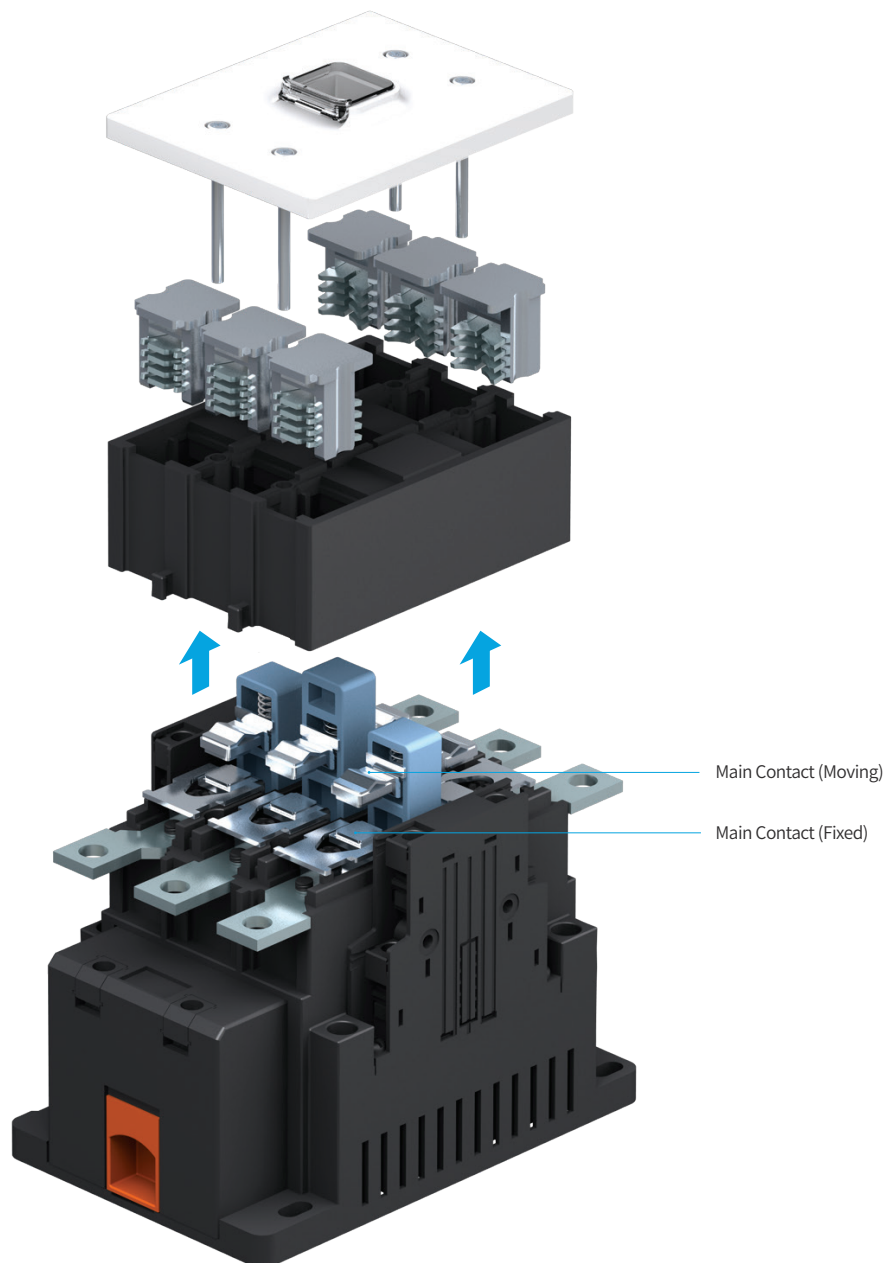

## Technical Data

### Accessories of Magnetic Contactor [9 ~ 100 AF]

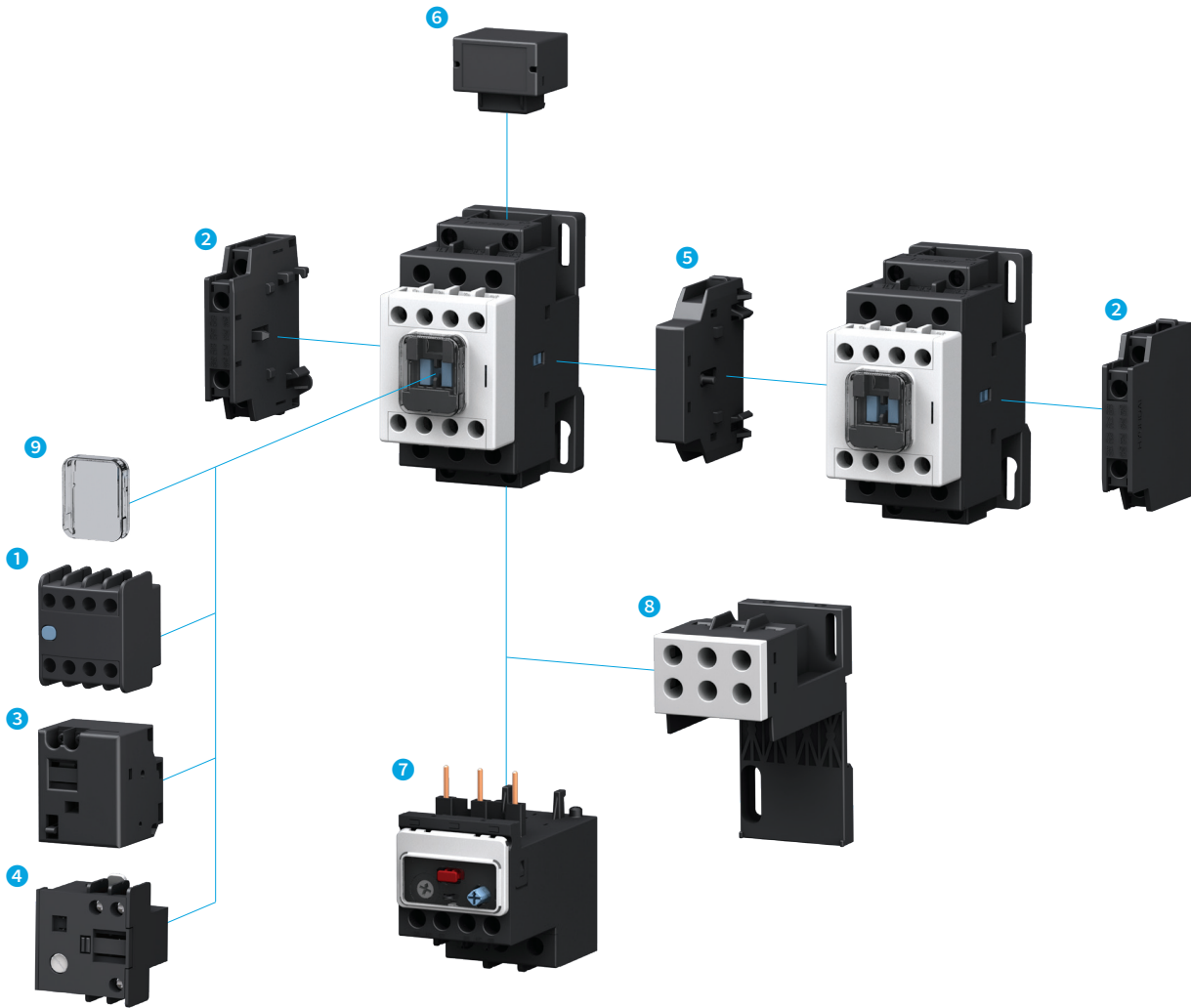

#### 9 ~ 100 AF Accessories

- |  |                                    |
|--|------------------------------------|
| ① Auxiliary Contact Block (Front) HGC TB | ⑥ Surge Absorber HGC RC/CD         |
| ② Auxiliary Contact Block (Side) HGC SB  | ⑦ Thermal Overload Relay HGT       |
| ③ Mechanical Latching Block HGC LB 100   | ⑧ Installation Unit HGTM B         |
| ④ Timer HGC ET                           | ⑨ Front Protection Cover HGCFC 100 |
| ⑤ Interlock Unit HGC IU                  |                                    |

## Accessories of Magnetic Contactor [115 ~ 800 AF]

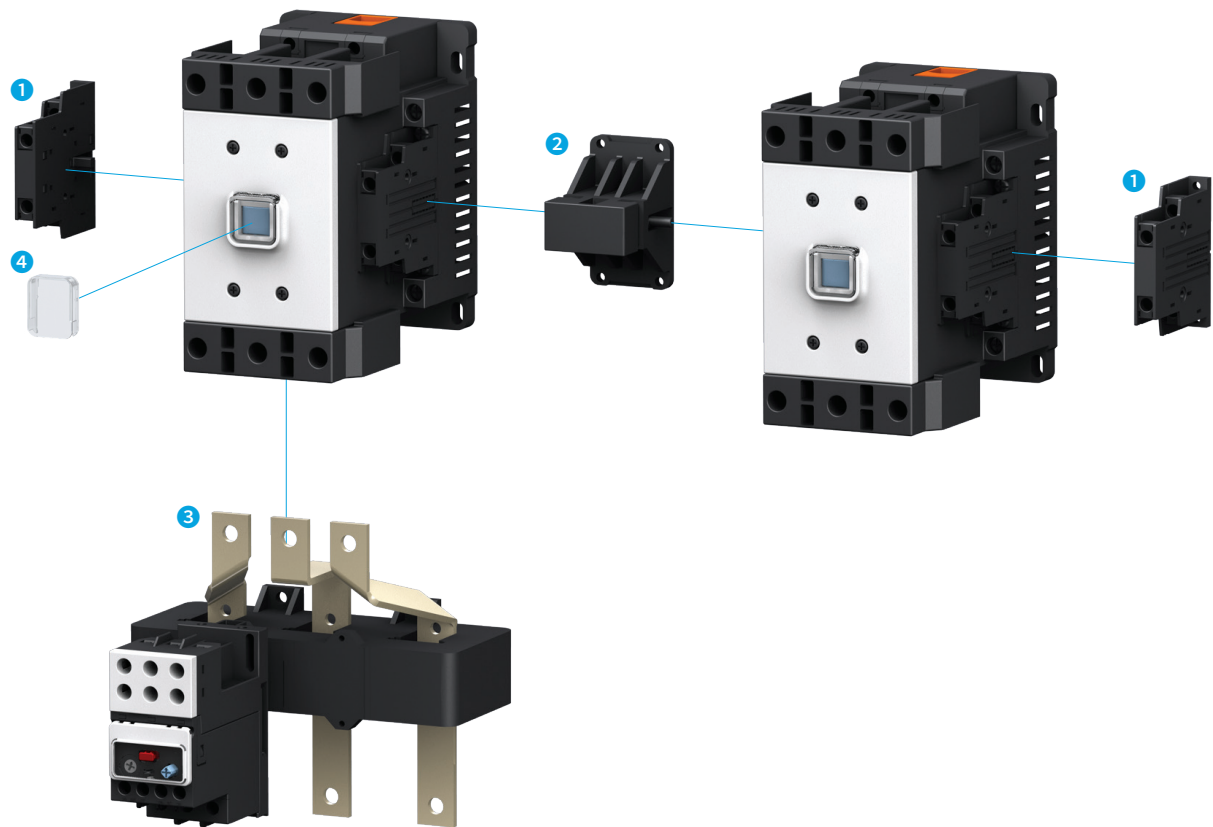

## 115 ~ 800 AF Accessories

- 1 Auxiliary Contact Block HGC SB
- 2 Interlock Unit HGC IU
- 3 Thermal Overload Relay HGT
- 4 Front Protection Cover HGFCF

# Technical Data

## Operational Coil Ratings

### HGC

Magnetic Contactor Model Name			HGC9	HGC12	HGC18	HGC25	HGC32	HGC40	HGC50	HGC65	HGC75	HGC85	HGC100									
<b>Power Consumption</b>																						
AC, DC	AC Operation (220 V/60 Hz)	Closed	VA	80	80	80	80	80	80	200	200	300	300	300								
		Maintained	VA/W	10/2.5	10/2.5	10/2.5	10/2.5	10/2.5	10/2.5	15/5	15/5	25/10	25/10	25/10								
	DC Operation	Closed	W	10	10	10	10	10	10	200	200	350	350	350								
		Maintained	W	10	10	10	10	10	10	5	5	8	8	8								
Both AC·DC	AC Operation (220 V/60 Hz)	Closed	VA	-	-	-	-	-	-	-	-	-	-	-								
		Maintained	VA/W	-	-	-	-	-	-	-	-	-	-	-								
	AC Operation (110 V/60 Hz)	Closed	VA	-	-	-	-	-	-	-	-	-	-	-								
		Maintained	VA/W	-	-	-	-	-	-	-	-	-	-	-								
	DC Operation	Closed	W	-	-	-	-	-	-	-	-	-	-	-								
		Maintained	W	-	-	-	-	-	-	-	-	-	-	-								
<b>Operating Time</b>																						
AC, DC	When Closed, Coil On → Main Contact On	AC	msec	12 ~ 30	12 ~ 30	12 ~ 30	12 ~ 30	12 ~ 30	12 ~ 30	9 ~ 18	9 ~ 18	15 ~ 30	15 ~ 30	15 ~ 30								
		DC		45 ~ 55	45 ~ 55	45 ~ 55	45 ~ 55	45 ~ 55	45 ~ 55	10 ~ 18	10 ~ 18	15 ~ 30	15 ~ 30	15 ~ 30								
Both DC·AC		AC		-	-	-	-	-	-	-	-	-	-	-	-							
		DC		-	-	-	-	-	-	-	-	-	-	-	-							
AC, DC	When Blocked, Coil Off → Main Contact Off	AC	8 ~ 15	8 ~ 15	8 ~ 15	8 ~ 15	8 ~ 15	8 ~ 15	13 ~ 20	13 ~ 20	13 ~ 20	13 ~ 20	13 ~ 20									
		DC	6 ~ 18	6 ~ 18	6 ~ 18	6 ~ 18	6 ~ 18	6 ~ 18	13 ~ 20	13 ~ 20	13 ~ 20	13 ~ 20	13 ~ 20									
Both DC·AC		AC	-	-	-	-	-	-	-	-	-	-	-									
		DC	-	-	-	-	-	-	-	-	-	-	-									
<b>Operation TR</b>																						
AC, DC	Min. Capacity	VA	60	60	60	60	60	60	150	150	200	200	200									
Both DC·AC			-	-	-	-	-	-	-	-	-	-	-	-								
<b>Type of Operation Coil Voltage</b>			<table border="1"> <thead> <tr> <th>Item</th> <th>Operational Voltage</th> </tr> </thead> <tbody> <tr> <td>AC 50 Hz</td> <td>24, 48, 110, 120, 220, 240, 380, 440 V</td> </tr> <tr> <td>AC 60 Hz</td> <td>24, 48, 110, 120, 220, 240, 380, 440 V</td> </tr> <tr> <td>DC</td> <td>24, 48, 110, 125, 220 V</td> </tr> </tbody> </table>												Item	Operational Voltage	AC 50 Hz	24, 48, 110, 120, 220, 240, 380, 440 V	AC 60 Hz	24, 48, 110, 120, 220, 240, 380, 440 V	DC	24, 48, 110, 125, 220 V
Item	Operational Voltage																					
AC 50 Hz	24, 48, 110, 120, 220, 240, 380, 440 V																					
AC 60 Hz	24, 48, 110, 120, 220, 240, 380, 440 V																					
DC	24, 48, 110, 125, 220 V																					
<p>1. Voltage : 85 ~ 110 %                  2. Exceeding the rated voltage causes damage in coil and electronic parts, ultimately reducing the product performance.                  3. If operational voltage other than the rated voltage is required, it can be customized. Contact our company upon order.</p>																						

※ The operating time of the product for both DC/AC is the average data based on AC 220 V 60 Hz, DC 110 V. As for HGC9-100, the A1 and A2 terminal at the live and load side is not separately respectively and as it is common (connected), ensure that short-circuit does not occur during wiring.

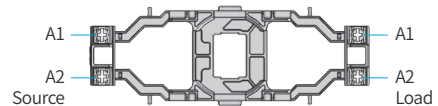

## Auxiliary Contact Ratings



### IEC 60947

Rated Insulation Voltage (Ui)	AC 750 V							
Rated Operational Current (Ith)	16 A							
Rated Current	AC12 (Resistive Load)		AC15 (Coil Load)		DC12 (Resistive Load)		DC13 (Coil Load)	
	110 V	10 A	110 V	6 A	24 V	4 A	24 V	4 A
	220 V	8 A	220 V	4 A	48 V	2.5 A	48 V	2.5 A
	440 V	6 A	440 V	3 A	125 V	1.1 A	125 V	1.1 A
	690 V	2 A	690 V	2 A	220 V	0.3 A	250 V	0.3 A



HGC115	HGC130	HGC150	HGC185	HGC225	HGC265	HGC300	HGC400	HGC500	HGC630	HGC800
-	-	-	-	-	-	-	-	-	-	-
-	-	-	-	-	-	-	-	-	-	-
-	-	-	-	-	-	-	-	-	-	-
-	-	-	-	-	-	-	-	-	-	-
530	530	530	360	360	360	390	390	390	1,700	1,700
7.4/3.8	7.4/3.8	7.4/3.8	9.3/5.8	9.3/5.8	9.3/5.8	9.3/5.8	9.3/5.8	9.3/5.8	17.1/10.6	17.1/10.6
240	240	240	250	250	250	250	250	250	850	850
3.3/2.1	3.3/2.1	3.3/2.1	6.4/4.4	6.4/4.4	6.4/4.4	6.4/4.4	6.4/4.4	6.4/4.4	10.5/8	10.5/8
193	193	193	420	420	420	420	420	420	850	850
2.3	2.3	2.3	3.4	3.4	3.4	3.4	3.4	3.4	9.5	9.5
-	-	-	-	-	-	-	-	-	-	-
-	-	-	-	-	-	-	-	-	-	-
40 ~ 80	40 ~ 80	40 ~ 80	40 ~ 80	40 ~ 80	40 ~ 80	40 ~ 80	40 ~ 80	40 ~ 80	45 ~ 150	45 ~ 150
70 ~ 80	70 ~ 80	70 ~ 80	35 ~ 45	35 ~ 70	35 ~ 70	35 ~ 70	35 ~ 70	35 ~ 70	45 ~ 150	45 ~ 150
-	-	-	-	-	-	-	-	-	-	-
-	-	-	-	-	-	-	-	-	-	-
18 ~ 25	18 ~ 25	18 ~ 25	40 ~ 50	40 ~ 50	40 ~ 50	35 ~ 50	35 ~ 50	35 ~ 50	45 ~ 150	45 ~ 150
15 ~ 20	15 ~ 20	15 ~ 20	35 ~ 45	35 ~ 45	35 ~ 45	35 ~ 45	35 ~ 45	35 ~ 45	45 ~ 150	45 ~ 150
-	-	-	-	-	-	-	-	-	-	-
200	200	200	200	200	200	200	200	200	1,000	1,000

## AC/DC

Nominal Voltage	AC	DC
220 V	100 ~ 240 V	110 ~ 220 V
440 V	380 ~ 450 V	-

## AC/DC

Nominal Voltage	AC	DC
110 V	100 ~ 127 V	100 ~ 110 V
220 V	200 ~ 240 V	200 ~ 220 V
440 V	380 ~ 450 V	-

## UL and CSA

Current	16 A			
	AC		DC	
Rated Current	120 V	6 A	125 V	1.1 A
	240 V	3 A	250 V	0.3 A
	480 V	1.5 A	440 V	0.2 A
	600 V	1.2 A	600 V	0.2 A

※ Contact Rating Code : A600 ~ P150

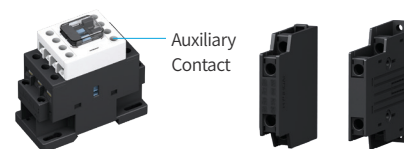

## Technical Data

### Structure and Characteristics of Thermal Overload Relay

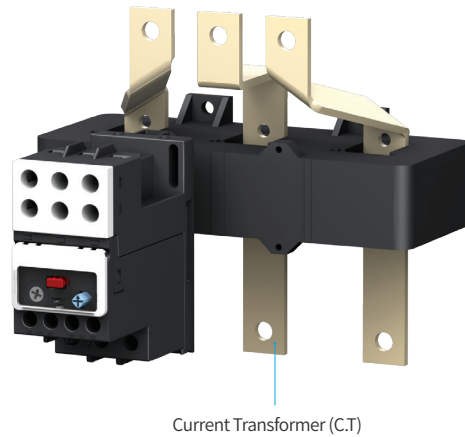
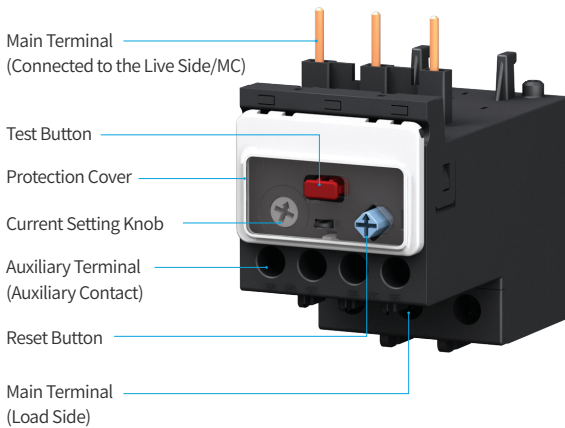

#### Test Button

- Pressing the test button for emergency stop during motor operation will open the magnetic contact and stop operation.
- To test the contact operation of the thermal overload relay, the test button can be pulled up to change the contact status for prompt testing. The voltage supplied for the power consumption of the coil, capacitance of control circuit and others need to be reviewed to apply an appropriate conductor length within the limit.

#### Reset Button

- A (Auto) Mode : Auto Reset
- H (Manual) Mode : Manual Reset



#### Protection Cover

- The front of the operating side is covered with a transparent protection cover so that the current value setting and reset operating method cannot be changed arbitrarily.
- To change the setting, lift the transparent cover up.

#### Current Setting Knob

The rated current setting can be set in 3 stages by using the +/-screw driver.

#### Wiring Protection : Differential Trip Device

As seen in the figure, if only the S, T-phase bimetal are curved because R phase is in open position, the lower slide is moved by the S, T phase bimetal. As for the trip lever, only the end part moves as much as the transfer ratio of upper and lower slide and it can be contacted with trip device. This is tripped at shorter period compared with the 3-phase overload state. This is equivalent for the wiring of S, T-phase.

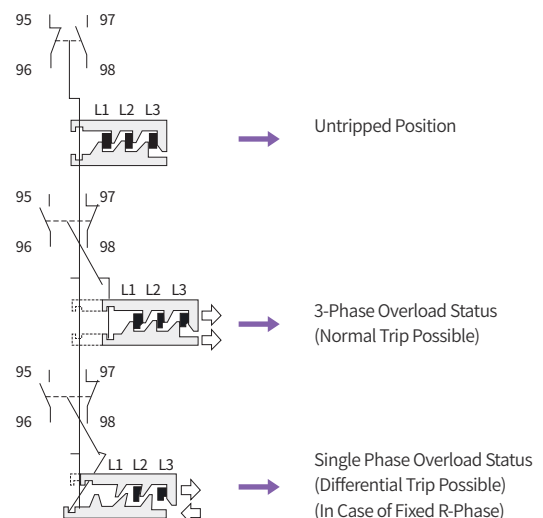

## Selection

### In Case the Starting Time is Short

- In case of squirrel-cage type of motor with starting time within a few seconds, the selection of overload relay can be selected by referring to the selection table and ratings of the overload relay. In such a case, the rated current of the motor must be selected within the current scale scope of the overload relay. The starting time of the rotating device with big inertia is an important factor in selecting the nominal rating of the overload relay.
- In case the starting time of the motor is 6~7 times the rated current, the trip time of the overload relay can be realized in the characteristic curve and this trip time must be selected as approximately 125 % of the start-up time.

### In Case the Starting Time is Long

- In case the starting time is longer than the trip time of the HGT18, the HGT Type with the current converter (C.T) must be used.
- The current converter is included in the arrangement of the rated current flowing to the first converter so the overload relay is not tripped during the starting time of the motor and in the lower rated current range, the live wire at the primary current converter has to be wired several times to obtain the time delay characteristics.

### Current Setting Ratio Following the Number of Wirings (Ex. : 130 A)

No. of Wirings	Current Range	1 <sup>st</sup> , 2 <sup>nd</sup> Current Ratio
1	78 ~ 130	130/5
2	39 ~ 65	65/5
3	26 ~ 26.7	26.7/5
4	19.5 ~ 43.3	43.3/5
5	15.6 ~ 26	26/5
6	13 ~ 21.7	21.7/5
7	11.14 ~ 18.5	18.5/5
8	9.75 ~ 16.25	16.25/5

$$\text{Setting Current (A)} = \frac{\text{Motor's Rated Current}}{\text{Current Converter's Current}}$$

The secondary rated current of the current converter is 5 A and as for the overload relay, it can be adjusted up to 3 ~ 5 A. The setting current value of this range can be calculated as below.

### Auxiliary Contact's Closed Circuit and Short-Circuit Current

Item per Category	AC15 <sup>1)</sup>	
	Auxiliary Contact 95 ~ 96 le (A)	Auxiliary Contact 97 ~ 98 le (A)
Voltage (V)		
110	2	1.2
220	1.5	1
500	1	0.5
660	0.5	0.3

Item per Category	DC13 <sup>2)</sup>	
	Auxiliary Contact 95 ~ 96 le (A)	Auxiliary Contact 97 ~ 98 le (A)
Voltage (V)		
24	1	1
110	0.4	0.4
220	0.15	0.15
440	0.07	0.07

※ 1) AC15 : Closed circuit and short-circuit current =  $le \times 10$

2) DC13 : Closed circuit and short-circuit current =  $le \times 1.1$

## Technical Data

### Characteristic Curve of Thermal Overload Relay

- The trip curve at 3-phase overload indicates the average trip time based on the ambient temperature of 20 °C Cold Start. (Hot Start : 20 ~ 40 % of Cold Start).
- The trip curve at wiring overload has the trip time of about 40 ~ 60 % of the 3-phase overload trip time.

HGT18K

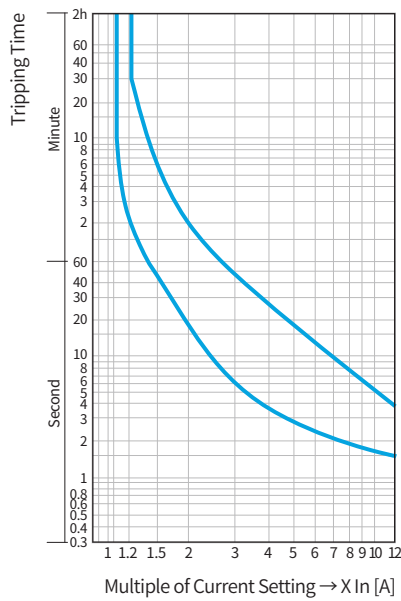

HGT40K

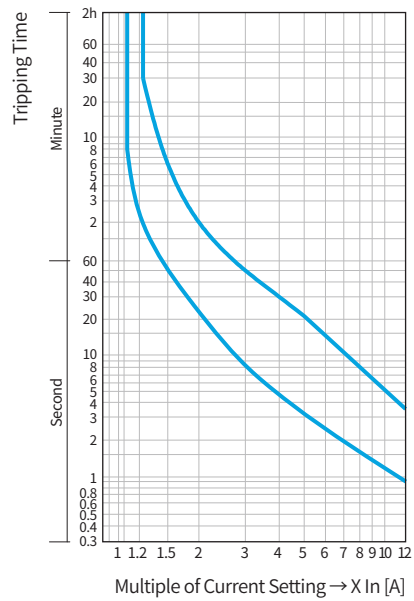

HGT65K

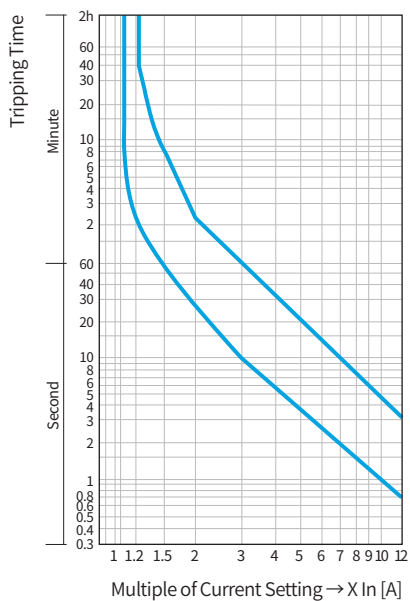

HGT100K

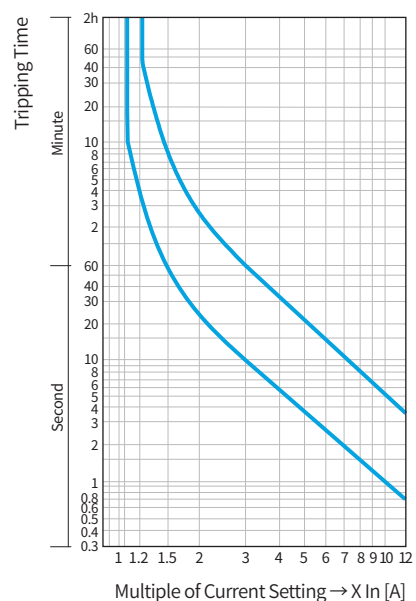

**HGT150K**

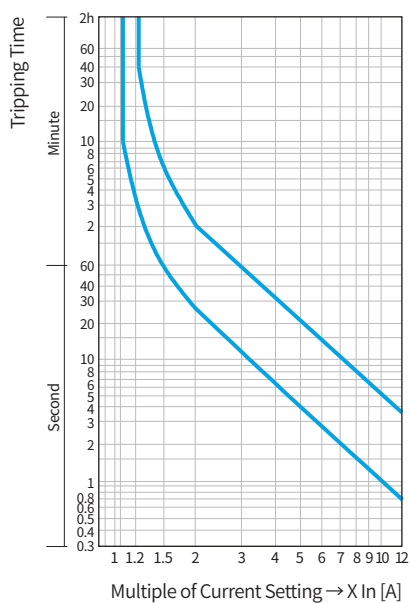

**HGT265K**

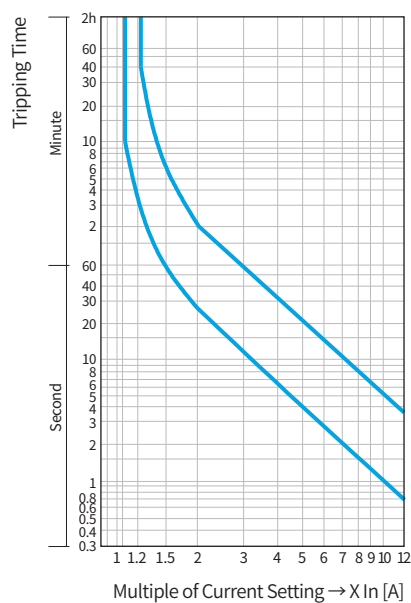

**HGT400K**

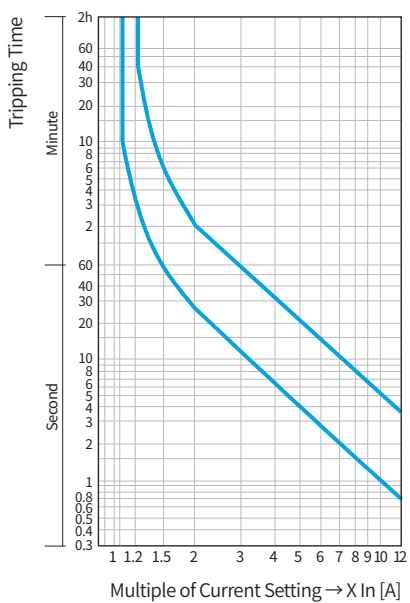

**HGT800K**

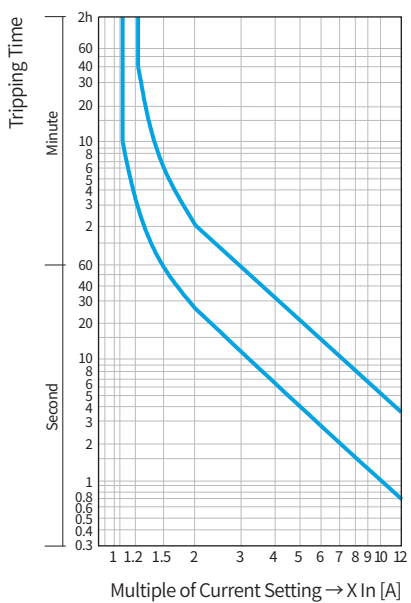

## Technical Data

### Connectable Wire and Fastening Torque

#### Main Circuit

Type	Size of Main Terminal	Stranded + Pin Terminal (mm <sup>2</sup> )		Single Wire (mm <sup>2</sup> )	Stranded Wire (mm <sup>2</sup> )	Max. Terminal Width (mm)	Fastening Torque [kgf.cm]
HGC9/12/18	M4	1...10	1...6	1...10	1...10	10	15
HGC25/32/40	M5	1...10	1...6	2.5...16	2.5...16	12	26
HGC50/65	M6	N/A		6...25	6...25	13	40
HGC75/85/100	M8	N/A		10...50	10...50	17	60
HGC115/130/150		N/A		35...95	35...95	25	
HGC185/225/265	M10	N/A		50...185	50...185	25	100
HGC300	M12	N/A		95...240	95...240	30	140
HGC400		N/A		185 ~ 185×2	185 ~ 185×2	30	
HGC500		N/A		185 ~ 240×2	185 ~ 240×2	30	
HGC630		N/A		240 ~ 240×2	N/A	40	
HGC800		N/A		2×busbar (60×5)	N/A	40	
HGC9 ~ 800Aux/Coil	M3.5	0.5...5.5		0.75...5.5	0.75...5.5	7.5	12

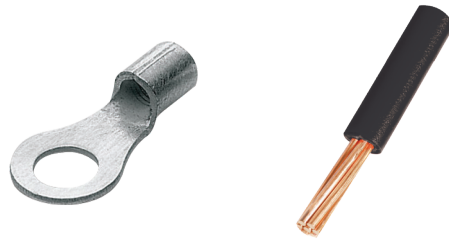



## Characteristics and Applications

The ratings of magnetic contactor is determined by the rated thermal current (I<sub>th</sub>), rated operating (I<sub>e</sub>), rated making and breaking capacity, electrical and mechanical lifespan and application category.

 IEC 60947	AC1	Non-inductive or slightly inductive loads, resistance furnaces
	AC2	Slip-ring motor : starting, switching off
	AC3	Squirrel cage motor : Starting, switching
	AC4	Squirrel cage motor : Starting, reverse-phase plugging and inching
	AC12	Control of resistive load
	AC15	Control of coil load
	DC1	Non-inductive or slightly inductive load, resistance furnaces
	DC3	Shunt motor : Starting, reverse-phase plugging and inching
	DC5	Series motor : Starting, reverse-phase plugging and inching
	DC12	Control of resistive load
	DC13	Control of coil load

### Rating Classification per Category based on Closing and Short-Circuit Current

Category	Closing				Closing and Short-Circuit			
	Current	Voltage	Power Factor	Cycle	Current	Voltage	Power Factor	Cycle
AC1	-	-	-	-	1.5 I <sub>e</sub>	1.05 U <sub>e</sub>	0.8	50
AC2	-	-	-	-	4.0 I <sub>e</sub>	1.05 U <sub>e</sub>	0.65	50
AC3	10.0 I <sub>e</sub>	U <sub>e</sub>	0.45 (≤100 A)	50	8.0 I <sub>e</sub>	1.05 U <sub>e</sub>	0.45 (≤100 A)	50
AC4	12.0 I <sub>e</sub>	U <sub>e</sub>	0.35 (>100 A)	50	10.0 I <sub>e</sub>	1.05 U <sub>e</sub>	0.35 (>100 A)	50
AC15	-	-	-	-	10.0 I <sub>e</sub>	1.10 U <sub>e</sub>	0.3	10
DC1	-	-	-	-	1.5 I <sub>e</sub>	1.05 U <sub>e</sub>	1	50
DC3	-	-	-	-	4.0 I <sub>e</sub>	1.05 U <sub>e</sub>	2.5	50
DC5	-	-	-	-	4.0 I <sub>e</sub>	1.05 U <sub>e</sub>	15	50
DC13	-	-	-	-	1.1 I <sub>e</sub>	1.10 U <sub>e</sub>	6P	10

### Rating Classification per Category based on Operating Test

Category	Closing and Short-Circuit				
	Current	Voltage	Power Factor	On-Time	Cycle
AC1	1.0 I <sub>e</sub>	1.05 U <sub>e</sub>	0.8	0.05 secs	6,000
AC2	2.0 I <sub>e</sub>	1.05 U <sub>e</sub>	0.65	0.05 secs	6,000
AC3	2.0 I <sub>e</sub>	1.05 U <sub>e</sub>	0.45 (I <sub>e</sub> ≤ 100 A)	0.05 secs	6,000
AC4	6.0 I <sub>e</sub>	1.05 U <sub>e</sub>	0.35 (I <sub>e</sub> > 100 A)	0.05 secs	6,000
AC15	10.0 I <sub>e</sub>	1.10 U <sub>e</sub>	0.3	0.05 secs	6,000
DC1	1.0 I <sub>e</sub>	1.05 U <sub>e</sub>	1	0.05 secs	6,000
DC3	2.5 I <sub>e</sub>	1.05 U <sub>e</sub>	2	0.05 secs	6,000
DC5	2.5 I <sub>e</sub>	1.05 U <sub>e</sub>	7.5	0.05 secs	6,000
DC13	1.1 I <sub>e</sub>	1.10 U <sub>e</sub>	6P	0.05 secs	6,000

### Rating Classification per Category based on Electrical Lifespan

Category	Closing			Breaking		
	Current	Voltage	Power Factor	Current	Voltage	Power Factor
AC1	1.0 I <sub>e</sub>	1 U <sub>e</sub>	0.95	1 I <sub>e</sub>	1 U <sub>e</sub>	0.95
AC2	2.5 I <sub>e</sub>	1 U <sub>e</sub>	0.65	2.5 I <sub>e</sub>	1 U <sub>e</sub>	0.65
AC3	6.0 I <sub>e</sub>	1 U <sub>e</sub>	0.65 (I <sub>e</sub> ≤ 17 A)	6 I <sub>e</sub>	0.17 U <sub>e</sub>	0.65 (I <sub>e</sub> ≤ 17 A)
AC4	6.0 I <sub>e</sub>	1 U <sub>e</sub>	0.35 (I <sub>e</sub> > 17 A)	6 I <sub>e</sub>	1 U <sub>e</sub>	0.35 (I <sub>e</sub> > 17 A)
DC1	1.0 I <sub>e</sub>	1 U <sub>e</sub>	1	1 I <sub>e</sub>	1 U <sub>e</sub>	1
DC3	2.5 I <sub>e</sub>	1 U <sub>e</sub>	2	2.5 I <sub>e</sub>	1 U <sub>e</sub>	2
DC5	2.5 I <sub>e</sub>	1 U <sub>e</sub>	7.5	2.5 I <sub>e</sub>	1 U <sub>e</sub>	7.5

※ I<sub>e</sub> : Rated current, U<sub>e</sub> : Rated voltage

## Technical Data

### Selections of AC3 and AC4 Grade Magnetic Contactor for Load

- In case of load operation with low switching frequency, the rated capacity of the magnetic contactor applied may increase and the increased rated capacity should not exceed the closing and short-circuit capacity of the magnetic contactor. In case a thermal overload relay is used, the short-circuit protection should carefully be considered within the range that does not exceed the maximum capacity of the fuse
- The magnetic contactor must be selected by considering the electrical lifespan curve.

#### Life Curve of AC3 Category (380 ~ 440 VAC)

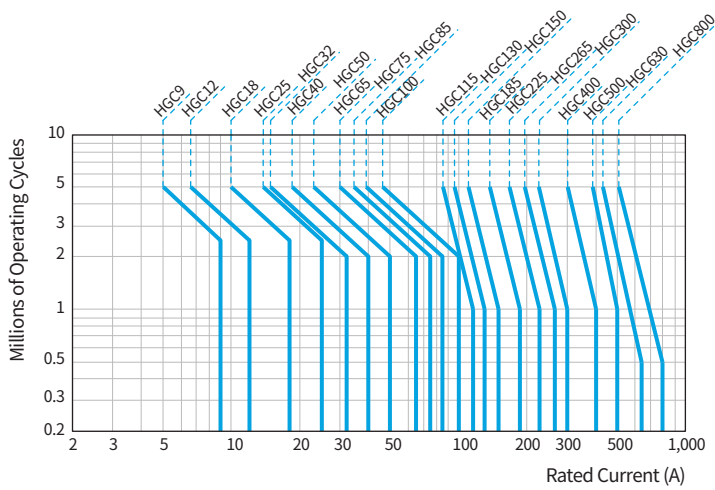

In case of load comprised of AC3 and AC4 category, the electrical lifespan of the magnetic contactor can be calculated using the following formula

$$L = \frac{1}{P1/L1 + P2/L2 + \dots + Pn/Ln}$$

- L : Electrical Lifespan of Contactor
- L 1 : Electrical Lifespan of AC3 Category
- L 2 : Electrical Lifespan of AC4 Category
- P1 : Coefficient Rate in AC3 Category
- P2 : Coefficient Rate in AC4 Category
- P1 + P2 + ... + Pn = 1

#### Life Curve of AC4 Category (380 ~ 440 VAC)

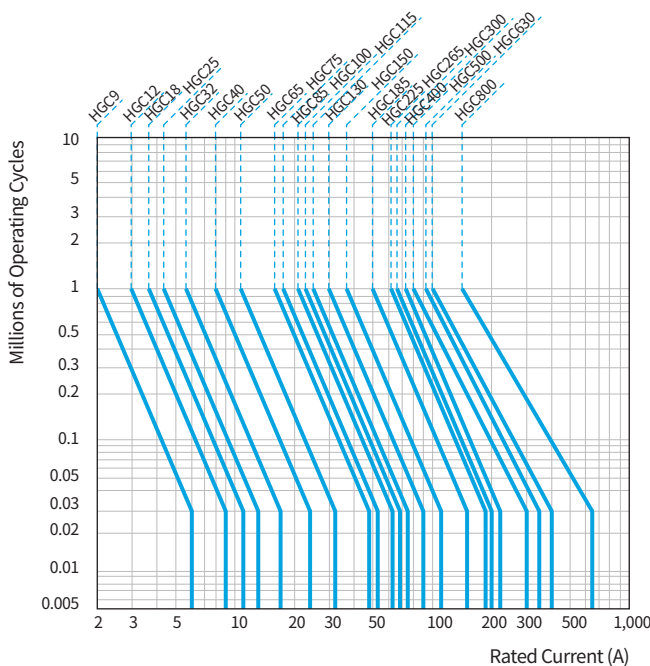

※ Example)

80 A/440 VAC. What is the electrical lifespan when UMC100 is applied in case of a motor with 480 A operational current of 95 % coefficient rate, operational current of 70 A in AC3 category, 5 % coefficient rate and operational current of 400 A in AC4 category?

$$L = \frac{10^6}{0.95/2.0 + 0.05/0.03} = 0.47 \times 10^6$$

- Lifespan of UMC100 in AC3 category life curve is  $2.0 \times 10^6$  (In case the operational current is 70 A)
- Lifespan of UMC100 in AC4 category is  $0.03 \times 10^6$  (In case the operational current is 400 A)

## Rated Operational Current with DC Load

Connection	Application	Operational Voltage	HGC9	HGC12	HGC18	HGC25	HGC32	HGC40	HGC50	HGC65	HGC75	HGC85	HGC100
2 Poles in Series	DC1 Resistive Load (L/R≤1 ms)	24V	10	12	18	20	25	35	50	65	65	75	80
		48V	10	12	18	20	25	35	40	65	65	65	65
		110V	6	10	13	15	25	25	35	45	45	50	50
		220V	3	7	8	10	12	12	15	15	15	20	20
	DC3,5 DC Motor Load (L/R≤15 ms)	24V	8	12	12	20	25	35	45	45	45	65	65
		48V	4	6	6	15	20	20	25	25	25	40	40
		110V	2.5	4	4	8	10	10	15	15	15	20	20
		220V	0.8	1.2	1.2	2	3	3	3.5	3.5	3.5	5	5
	DC13 Coil Load (L/R≤40 ms)	24V	8	12	12	20	25	35	-	-	-	-	-
		48V	4	6	6	12	15	15	-	-	-	-	-
		110V	2	3	3	3	4	4	-	-	-	-	-
		220V	0.3	0.5	0.5	1.2	1.2	1.2	-	-	-	-	-
3 Poles in Series	DC1 Resistive Load (L/R≤1 ms)	24V	10	12	18	20	25	35	50	65	65	75	80
		48V	10	12	18	20	25	35	50	65	65	75	80
		110V	8	12	18	20	25	35	50	65	65	75	80
		220V	8	12	18	20	25	30	40	50	50	55	60
	DC3,5 DC Motor Load (L/R≤15 ms)	24V	8	12	12	20	25	35	50	50	50	80	80
		48V	6	10	10	20	25	30	35	35	35	60	60
		110V	4	8	8	15	20	20	30	30	30	50	50
		220V	2	4	4	8	10	10	12	12	12	20	20
	DC13 Coil Load (L/R≤40 ms)	24V	8	12	12	20	25	35	-	-	-	-	-
		48V	6	10	10	15	25	35	-	-	-	-	-
		110V	3	5	5	10	12	12	-	-	-	-	-
		220V	0.8	2	2	4	4	4	-	-	-	-	-

Connection	Application	Operational Voltage	HGC115	HGC130	HGC150	HGC185	HGC225	HGC265	HGC300	HGC400	HGC500	HGC630	HGC800
2 Poles in Series	DC1 Resistive Load (L/R≤1 ms)	24V	100	120	150	180	220	260	300	400	500	630	800
		48V	100	100	120	180	180	220	240	240	300	630	800
		110V	80	80	100	150	150	180	200	200	220	630	630
		220V	50	50	100	150	150	180	200	200	220	630	630
	DC3,5 DC Motor Load (L/R≤15 ms)	24V	100	120	150	180	220	260	300	400	500	630	800
		48V	60	60	100	150	150	180	200	200	260	630	800
		110V	40	40	80	120	120	130	150	150	180	630	630
		220V	30	30	60	80	80	80	90	90	130	210	210
	DC13 Coil Load (L/R≤40 ms)	24V	-	-	-	-	-	-	-	-	-	-	-
		48V	-	-	-	-	-	-	-	-	-	-	-
		110V	-	-	-	-	-	-	-	-	-	-	-
		220V	-	-	-	-	-	-	-	-	-	-	-
3 Poles in Series	DC1 Resistive Load (L/R≤1 ms)	24V	100	120	150	180	220	260	300	400	500	630	800
		48V	100	120	150	180	220	260	300	400	500	630	800
		110V	100	100	150	180	220	260	300	400	500	630	630
		220V	80	80	150	180	220	260	300	300	400	630	630
	DC3,5 DC Motor Load (L/R≤15 ms)	24V	100	120	150	180	220	260	300	400	500	630	800
		48V	90	90	130	180	220	260	280	280	400	630	800
		110V	80	80	120	150	150	180	200	200	260	630	630
		220V	50	50	80	100	100	130	150	150	180	310	310
	DC13 Coil Load (L/R≤40 ms)	24V	-	-	-	-	-	-	-	-	-	-	-
		48V	-	-	-	-	-	-	-	-	-	-	-
		110V	-	-	-	-	-	-	-	-	-	-	-
		220V	-	-	-	-	-	-	-	-	-	-	-

## Technical Data

### Ratings for Transformer and Condenser Load

Connection	Operational Voltage	HGC9	HGC12	HGC18	HGC25	HGC32	HGC40	HGC50	HGC65	HGC75	HGC85	HGC100	
Transformer (kVA)	Single Phase	AC 220 V	1	1.5	2	2.5	3	4	5	7	8	9	10
		AC 440 V	1.5	2	3	4	5	7.5	10	15	17	18	20
	3 Phase	AC 220 V	2	3	3.5	4	5	6.5	10	12	13	15	18
		AC 440 V	2.5	4	5	7.5	10	12	18	25	27	30	35
Condenser (kVAR)	3 Phase	AC 220 V	2	3	4	5	9	11	13	17	20	22	24
		AC 440 V	3	4	6	10	16	20	24	34	40	45	48

Connection	Operational Voltage	HGC115	HGC130	HGC150	HGC185	HGC225	HGC265	HGC300	HGC400	HGC500	HGC630	HGC800	
Transformer (kVA)	Single Phase	AC 220 V	-	15	17	20	25	30	33	44	55	65	90
		AC 440 V	-	25	33	40	50	57	66	90	110	130	175
	3 Phase	AC 220 V	-	25	30	35	42	48	57	75	90	110	150
		AC 440 V	-	42	60	70	85	95	100	150	180	220	300
Condenser (kVAR)	3 Phase	AC 220 V	-	29	35	42	58	63	69	92	115	145	185
		AC 440 V	-	58	70	84	115	125	139	185	230	291	369

※ The abovementioned table is applicable in case the inrush current of the transformer is less than 30 times the rated current (RMS).  
Electrical lifespan : 100,000 times (Based on IEC 60947-4-1, AC6a, 6b)

### Light Load – Number of Incandescent Lamp that can be Switched

#### Application of Lighting Load

Other than special cases, the lighting load has relatively low electrical lifespan or switching frequency. In case of selecting magnetic contactor, the total input current of the load cannot exceed the rated current and the inrush current caused by lighting cannot exceed the breaking current capacity of the magnetic contactor.

#### Incandescent Lamp

The filament of the incandescent lamp has lower resistance in ordinary temperature so when the voltage is applied, the current that is 13~16 times the rated current flows but in room temperature, the impedance of the circuit causes the excessive current to be suppressed to about 7~10 times the rated current due to self-heating. Magnetic contact with incandescent lamp has to consider this excessive current and the rating current of the incandescent lamp shall be selected within the rated operational current of AC3 category.

Power Voltage		110 V							
Power Consumption		100 W	150 W	200 W	250 W	300 W	500 W	1,000 W	1,500 W
Magnetic Contactor	HGC9	11	7	5	4	2	2	1	-
	HGC12	14	8	6	5	4	2	1	-
	HGC18	19	13	10	7	6	3	1	1
	HGC25	20	13	10	8	6	3	1	1
	HGC32	28	18	14	11	9	5	2	1
	HGC40	38	25	19	15	12	7	3	2
	HGC50	55	35	27	22	16	10	5	3

Power Voltage		220 V							
Power Consumption		100 W	150 W	200 W	250 W	300 W	500 W	1,000 W	1,500 W
Magnetic Contactor	HGC9	22	14	11	8	7	4	2	1
	HGC12	26	18	14	10	8	5	2	1
	HGC18	38	25	20	15	13	7	3	2
	HGC25	40	27	20	16	13	8	3	2
	HGC32	55	36	28	22	18	11	5	3
	HGC40	75	50	38	30	25	15	7	4
	HGC50	105	70	54	43	35	22	10	6

## Application of Star-Delta Starting

### Voltage, Current, Torque for Start-Delta Starting

Starting Method	Starting (Start Type Magnetic Contactor / C3)				Operating (Delta Type Magnetic Contactor / C2)		
	Starting Current	Torque	Full Load Current	Contact Voltage	Full Load Current	Contact Current	Contact Voltage
Direct	6 Im	1.5 T	6 Im	$Em/\sqrt{3}$	Im	Im	$Em/\sqrt{3}$
Star - Delta	2 Im	0.5 T	2 Im	$Em/\sqrt{3}$	Im	$Im/\sqrt{3}$	Em

※ Im : Load current in case the motor is connected to delta Em : Line voltage T : Rated torque (Estimated torque fluctuation)

### Application of Magnetic Contactor for Star - Delta Starting

200 ~ 240 V AC, 3 Ø, 60 Hz							380 ~ 440 V AC, 3 Ø, 60 Hz						
Motor Capacity			Main Circuit	Δ Circuit	Y Circuit	TOR	Motor Capacity			Main Circuit	Δ Circuit	Y Circuit	TOR
kW	Hp	FLC	(C1)	(C2)	(C3)		kW	Hp	FLC	(C1)	(C2)	(C3)	
5.5	7.5	22	HGC25	HGC25	HGC18	HGT40K	5.5	7.5	12	HGC25	HGC25	HGC25	HGT40K
7.5	10	32	HGC32	HGC32	HGC25	HGT40K	7.5	10	18	HGC25	HGC25	HGC25	HGT40K
11	15	40	HGC40	HGC40	HGC32	HGT40K	11	15	22	HGC25	HGC25	HGC25	HGT40K
15	20	50	HGC50	HGC50	HGC32	HGT65K	15	20	32	HGC32	HGC32	HGC25	HGT40K
18.5	25	70	HGC50	HGC50	HGC40	HGT65K	18.5	25	40	HGC40	HGC40	HGC25	HGT40K
22	30	80	HGC75	HGC75	HGC40	HGT100K	22	30	50	HGC40	HGC40	HGC32	HGT40K
30	40	110	HGC100	HGC100	HGC50	HGT100K	30	40	65	HGC50	HGC50	HGC40	HGT65K
37	50	130	HGC115	HGC115	HGC65	HGT150K	37	50	80	HGC75	HGC75	HGC40	HGT100K
45	60	150	HGC130	HGC130	HGC65	HGT150K	45	60	90	HGC75	HGC75	HGC40	HGT100K
55	75	180	HGC150	HGC150	HGC100	HGT150K	55	75	110	HGC100	HGC100	HGC50	HGT100K
75	100	260	HGC185	HGC185	HGC115	HGT265K	75	100	150	HGC115	HGC115	HGC65	HGT150K
90	125	300	HGC225	HGC225	HGC130	HGT265K	90	125	180	HGC130	HGC130	HGC100	HGT150K
110	150	367	HGC300	HGC300	HGC150	HGT500K	110	150	220	HGC150	HGC150	HGC115	HGT150K
132	180	434	HGC400	HGC400	HGC225	HGT500K	132	180	260	HGC185	HGC185	HGC115	HGT265K
160	220	519	HGC400	HGC400	HGC225	HGT500K	160	220	300	HGC225	HGC225	HGC130	HGT265K
250	350	810	HGC630	HGC630	HGC400	HGT800K	250	350	500	HGC400	HGC400	HGC225	HGT500K
300	-	-	-	-	-	-	300	402	560	HGC400	HGC400	HGC300	HGT500K

※ The data of this table is subject to change depending on the grade and manufacturer of the motor and is a reference for using AC3 category squirrel cage motor or AC2 category slip-ring motor. The starting time of the motor is based on less than 10 seconds. Select separately in case the starting time has a long load (Ex : Fan. Blower. Compressor). As for the load applied with phase advance condenser, consider the inrush current for selection. As for the transfer time of the timer contact for transfer, 30 ~ 80 ms is appropriate. As for the current setting of the overload relay (UTH), set the current of motor full load at 58 %.

#### Main Circuit

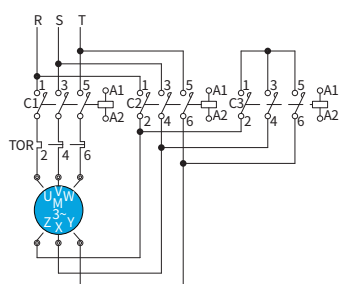

#### Control Circuit

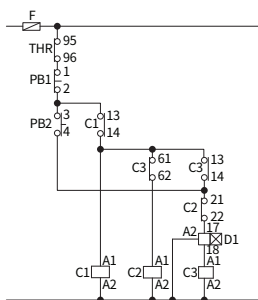

Connection Diagram 1 (HGC9 ~ 100)

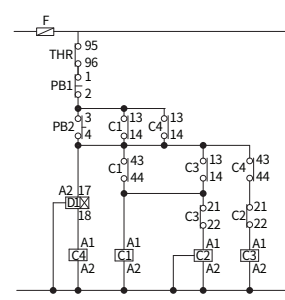

Connection Diagram 2 (HGC115 ~ 800)

C1 : Main MC C2 : Delta MC C3 : Star MC D1 : Timer C4 : Auxiliary relay

## Technical Data

### Ratings of Inching and Plugging

• AC rating category (Rated capacity in case of inching and plugging)

Category	Voltage	Ratio	Electrical Lifespan		HGC9	HGC12	HGC18	HGC25	HGC32	HGC40	HGC50	HGC65	HGC75	HGC85	HGC100
Inching	220 V	10 %	100,000	kW	2.2	2.7	3.7	4	5.5	7.5	11	15	18.5	19	25
			500,000		1	1.5	2.7	3.7	4.5	5.5	7.5	11	15	15	15
		50 %	100,000		1	1.5	2.7	3.7	4.5	5.5	7.5	11	15	15	19
			500,000		0.5	0.75	1.1	1.5	2.2	3.7	3.7	5.5	7.5	7.5	9
		100 %	100,000		0.75	1.1	1.5	2.5	4.5	4.5	5.5	7.5	9	11	11
			500,000		0.3	0.5	0.75	1.1	1.8	2.7	3.7	4	4	5.5	5.5
	440 V	10 %	100,000		2.7	4	4	7.5	11	15	22	30	37	37	50
			500,000		1.5	2.2	3.7	7.5	9	11	15	22	30	30	37
		50 %	100,000		1.5	3.7	4	7.5	9	11	15	22	30	30	37
			500,000		0.75	1.5	2.2	3.7	4.5	5.5	7.5	11	15	15	18.5
		100 %	100,000		1.1	2.2	3.7	5.5	7.5	11	15	15	15	22	25
			500,000		0.5	1.1	1.5	2.2	3.7	3.7	5.5	7.5	7.5	11	13
Plugging	220 V	Plugging Brake 100 %	100,000	kW	0.75	0.75	1.5	2.2	2.5	3.7	5.5	7.5	9	9	11
			500,000		0.2	0.4	0.5	0.75	1.1	1.5	22	3	3.7	3.7	4.5
	440 V		100,000		0.75	1	2.2	3.7	4.5	4.5	7.5	11	18.5	18.5	22
			500,000		0.2	0.4	0.75	1.5	2.2	2.2	3.7	5.5	7.5	7.5	11

Category	Voltage	Ratio	Electrical Lifespan		HGC115	HGC130	HGC150	HGC185	HGC225	HGC265	HGC300	HGC400	HGC500	HGC630	HGC800
Inching	220 V	10 %	100,000	kW	30	30	37	45	55	65	75	110	132	160	200
			500,000		15	22	25	30	37	45	50	65	70	75	132
		50 %	100,000		22	22	30	37	45	50	55	75	80	90	150
			500,000		9	9	11	15	19	22	25	30	32	37	45
		100 %	100,000		11	15	19	25	30	32	37	45	50	55	75
			500,000		5.5	7.5	9	11	15	17	22	25	30	37	45
	440 V	10 %	100,000		50	60	75	90	110	132	150	200	250	300	400
			500,000		37	45	55	75	90	110	125	132	140	150	190
		50 %	100,000		37	45	55	75	90	110	132	150	167	190	220
			500,000		18.5	22	30	37	37	42	50	75	80	90	110
		100 %	100,000		25	30	45	55	60	65	75	110	120	132	160
			500,000		13	15	22	25	30	32	37	55	63	75	90
Plugging	220 V	Plugging Brake 100 %	100,000	kW	11	15	19	22	25	30	37	45	50	55	75
			500,000		4.5	5.5	7.5	11	13	15	18.5	22	25	30	37
	440 V		100,000		22	30	37	45	45	49	55	75	90	110	150
			500,000		11	15	19	22	25	26	30	37	40	45	75

※ The inching limit of switching frequency is below 10 continuous operations      Inching (%) =  $\frac{\text{No. of Inching Operations}}{\text{No. of Standard Operations} + \text{No. of Inching Operations}} \times 100$



## Ratings based on UL

Item	HGC9	HGC12	HGC18	HGC25	HGC32	HGC40	HGC50	HGC65	HGC75	HGC85	HGC100		
Continuous Current (Ambient Temperature 40 °C)	A	21	21	30	40	50	60	70	80	90	105	125	
Single Phase	1 P/100 ~ 120 V	0.5/9.8	1/16	1.5/16	2/20	2/24	3/34	5/56	5/56	-	-	-	
	1 P/220 ~ 240 V	1/8	2/12	3/17	3/17	5/28	7.5/40	10/50	10/50	-	-	-	
Three Phase	3 P/220 ~ 240 V	hp/A	2/6.8	3/9.6	5/15.2	10/28	10/28	15/42	20/54	20/54	25/68	30/80	30/80
	3 P/440 ~ 480 V	5/7.6	7.5/11	10/14	20/27	25/34	30/40	40/52	40/52	60/77	60/77	60/77	
	3 P/550 ~ 600 V	5/6.1	10/11	15/21	15/21	20/22	30/32	30/42	40/52	50/52	50/52	75/77	
NEMA Size	00	00	0	0	1	1	2	2	2	3	3		

Item	HGC115	HGC130	HGC150	HGC185	HGC225	HGC265	HGC300	HGC400	HGC500	HGC630	HGC800		
Continuous Current (Ambient Temperature 40 °C)	A	160	180	210	230	260	330	350	450	550	750	900	
Single Phase	1 P/100 ~ 120 V	-	-	-	-	-	-	-	-	-	-	-	
	1 P/220 ~ 240 V	-	-	-	-	-	-	-	-	-	-	-	
Three Phase	3 P/220 ~ 240 V	hp/A	40/104	40/104	50/130	60/154	75/192	100/248	100/248	150/360	150/360	250/480	300/720
	3 P/440 ~ 480 V	75/96	75/96	100/124	125/156	150/180	200/240	250/302	300/361	300/361	500/477	600/708	
	3 P/550 ~ 600 V	100/99	100/99	125/125	150/144	200/192	250/242	250/242	300/289	350/336	500/382	600/578	
NEMA Size	3	3	4	4	4	4	5	5	5	6	7		

## Technical Data

### Effect on Magnetic Contactor Depending on the Cable Length of Control Circuit

#### Input Defect caused by Voltage Drop Following Inrush Current and Resistive (AC/DC)

Voltage drop occurs on the control circuit cable due to inrush current that is generated when the operational coil power of the contact is supplied. Due to such, the input into the magnetic contactor may fail. Therefore, the length of the conductor has to be reviewed within the appropriate limit by reviewing the input power consumption, supply voltage and the cross sectional area of the circuit conductor and others.

#### Calculation of the Allowable Conductor Length Following Inrush Power

This graph indicates the maximum 5% line voltage drop.

#### AC Circuit

##### Supply Voltage

- ① AC 24 V
- ② AC 48 V
- ③ AC 115 V
- ④ AC 230 V
- ⑤ AC 400 V
- ⑥ AC 690 V

##### C.S.A of Cu Cable

- Ⓐ 0.75 mm<sup>2</sup>
- Ⓑ 1 mm<sup>2</sup>
- Ⓒ 1.5 mm<sup>2</sup>
- Ⓓ 2.5 mm<sup>2</sup>
- Ⓔ 4 mm<sup>2</sup>
- Ⓕ 6 mm<sup>2</sup>

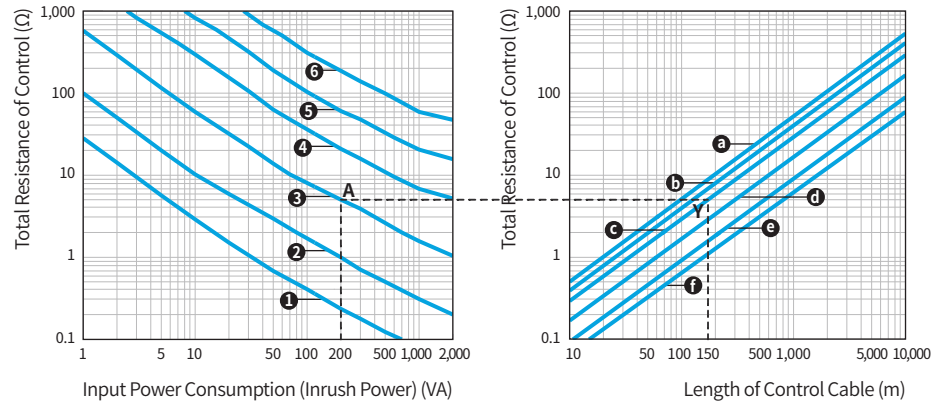

※ Ex.) The maximum length of conductor when using HGC50 magnetic contactor in a 1.5 mm<sup>2</sup> Cu cable at supply voltage of AC 115 V and input power consumption of 200 VA is 150 m.

#### DC Circuit

##### Supply Voltage

- ⑦ DC 24 V
- ⑧ DC 48 V
- ⑨ DC 125 V
- ⑩ DC 250 V

##### C.S.A of Cu Cable

- Ⓐ 0.75 mm<sup>2</sup>
- Ⓑ 1 mm<sup>2</sup>
- Ⓒ 1.5 mm<sup>2</sup>
- Ⓓ 2.5 mm<sup>2</sup>
- Ⓔ 4 mm<sup>2</sup>
- Ⓕ 6 mm<sup>2</sup>

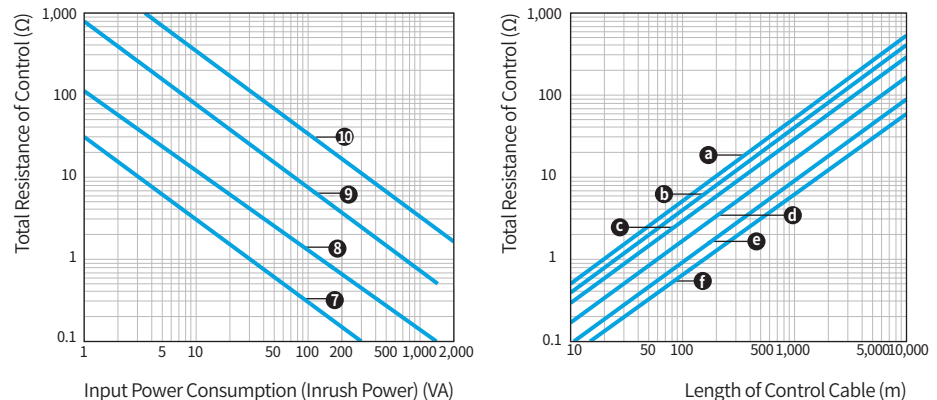

Calculation of the Maximum Cable Distance Following Voltage

$$L = \frac{U^2}{SA} \cdot s \cdot K$$

L : Distance between the conductor and control device, m (Length of cable)  
 U : Supply voltage, V  
 SA : Input power consumption (Inrush power), VA  
 s : C.S.A of conductor, mm<sup>2</sup>  
 K : Factors in the following table

AC Supply	SA (VA)	20	40	100	150	200
	K	1.38	1.5	1.8	2	2.15
DC Supply	Consistent, regardless of the inrush power's SA value (W)					
	k = 1.38					

Trip Failure caused by Cable Capacitance (AC)

When the connection with the contact is opened, trip failure may occur due to the capacitance between the control device and the magnetic contactor coil.

This phenomenon may get worsened by the length of cable between the control device and the contactor, high control circuit voltage, low coil power consumption, low drop-out value and others. So, an appropriate conductor length within the limit is required by reviewing the supply voltage of power consumption for maintaining coil, capacitance of control circuit and others.

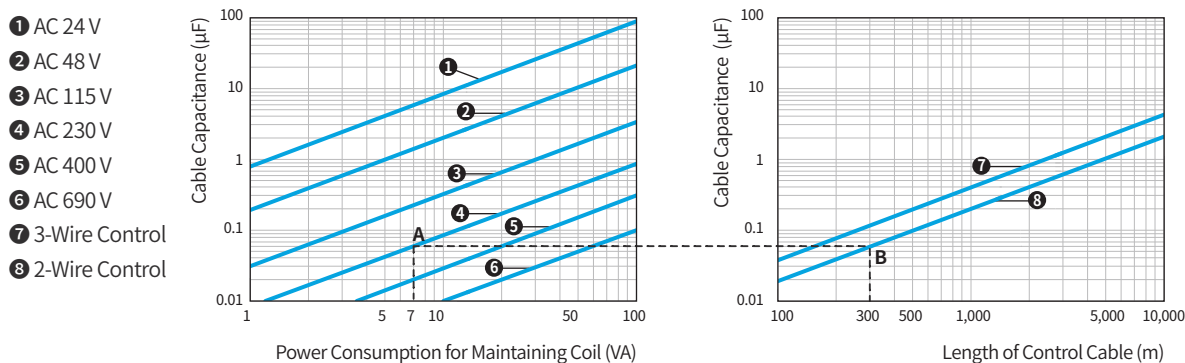

※ Ex.) The maximum length of conductor for stable trip when supply voltage of AC 230 V, power consumption for maintaining coil of 7 VA, w-wire control method are applied to HGC12 magnetic contactor is 300 m.

Calculation of Maximum Cable Distance Following Cable Capacitance

$$L = 455 \cdot \frac{S}{U^2 \cdot Co}$$

L : Distance between contact and control device, m (Length of cable)  
 U : Supply voltage, V  
 S : Power consumption for maintaining coil, VA  
 Co : Line capacity of cable

## Model Selection Table

### Magnetic Contactor : 9 ~ 800 AF

#### 9 ~ 40 AF

Model Name			HGC9	HGC12	HGC18	HGC25	HGC32	HGC40	
IEC 60947-4									
Rated Insulation Voltage [Ui]		V	800	800	800	800	800	800	
Rated Operational Voltage [Ue]		V	690	690	690	690	690	690	
Rated Impulse Withstand Voltage [Uimp]		kV	6	6	6	6	6	6	
Rated Thermal Current [Ith] (AC1)		A	25	25	40	45	55	60	
Rated frequency		Hz	50/60	50/60	50/60	50/60	50/60	50/60	
AC3	200 ~ 240 V		kW/A	2.5/9	3.5/12	4.5/18	5.5/25	7.5/32	11/40
	380 ~ 440 V			4/9	5.5/12	7.5/18	11/25	15/32	18.5/40
	500 ~ 550 V			4/7	7.5/12	8.5/13	15/22	18.5/28	22/32
	660 ~ 690 V			4/6	7.5/9	7.5/9	15/17	18.5/20	22/23
	1,000 V			-	-	-	-	-	-
Lifespan	Electrical Mechanical	10,000 times	250	250	250	250	200	200	
			1,500	1,500	1,500	1,500	1,500	1,500	
AC4	200 ~ 240 V		kW/A	1.5/8	2.2/11	3.7/16	3.7/18	4.5/22	5.5/25
	380 ~ 440 V			2.2/6	4/9	4/11	5.5/13	7.5/17	11/24
	Electrical Lifespan			10,000 times	3	3	3	3	3
Mounting Method			Screw & Rail Mounting			Screw & Rail Mounting			
Auxiliary Contact									
Standard	AC		1NO1NC or 2NO2NC			1NO1NC or 2NO2NC			
	DC		1NO1NC or 2NO2NC			1NO1NC or 2NO2NC			
Additional	AC		2NO2NC			2NO2NC			
	DC		2NO2NC			2NO2NC			
Dimensions									
AC	W×H×D	mm	45×94.2×91.1			45×99.6×96.6			
DC			45×94.2×124			45×99.6×129.5			

#### 50 ~ 100 AF

Model Name			HGC50	HGC65	HGC75	HGC85	HGC100	
IEC 60947								
Rated Insulation Voltage [Ui]		V	1,000	1,000	1,000	1,000	1,000	
Rated Operational Voltage [Ue]		V	690	690	690	690	690	
Rated Impulse Withstand Voltage [Uimp]		kV	8	8	8	8	8	
Rated Thermal Current [Ith] (AC1)		A	70	85	115	125	145	
Rated frequency		Hz	50/60	50/60	50/60	50/60	50/60	
AC3	200 ~ 240 V		kW/A	15/50	18.5/65	22/75	25/85	30/100
	380 ~ 440 V			22/50	30/65	37/75	45/85	55/100
	500 ~ 550 V			30/43	33/60	37/64	50/75	55/85
	660 ~ 690 V			30/28	33/35	37/42	45/45	50/65
	1,000 V			-	-	-	-	-
Lifespan	Electrical Mechanical	10,000 times	200	200	200	200	200	
			1,500	1,500	1,000	1,000	1,000	
AC4	200 ~ 240 V		kW/A	7.5/35	11/50	13/55	15/65	17/72
	380 ~ 440 V			15/32	22/47	25/52	30/62	33/68
	Electrical Lifespan			10,000 times	3	3	3	3
Mounting Method			Screw & Rail Mounting			Screw & Rail Mounting		
Auxiliary Contact								
Standard	AC		2NO2NC			2NO2NC		
	DC		2NO1NC			2NO1NC		
Additional	AC		2NO2NC			2NO2NC		
	DC		1NO1NC			1NO1NC		
Dimensions								
AC	W×H×D	mm	55×123.6×129			70×146×153		
DC			55×123.6×129			70×146×153		

## 115 ~ 265 AF

Model Name			HGC115	HGC130	HGC150	HGC185	HGC225	HGC265	
IEC 60947-4									
Rated Insulation Voltage [Ui]		V	1,000	1,000	1,000	1,000	1,000	1,000	
Rated Operational Voltage [Ue]		V	1,000	1,000	1,000	1,000	1,000	1,000	
Rated Impulse Withstand Voltage [Uimp]		kV	8	8	8	8	8	8	
Rated Thermal Current [Ith] (AC1)		A	160	180	210	275	315	350	
Rated frequency		Hz	50/60	50/60	50/60	50/60	50/60	50/60	
AC3	200 ~ 240 V		kW/A	37/115	40/130	45/150	55/185	75/225	80/265
	380 ~ 440 V			60/115	65/130	75/150	90/185	132/225	147/265
	500 ~ 550 V			59/100	70/120	90/140	110/180	132/200	150/225
	660 ~ 690 V			55/65	75/82	90/120	110/120	132/150	160/173
	1,000 V			65/50	75/54	90/66	110/78	132/96	160/113
	Lifespan	Electrical		10,000 times	100	100	100	100	100
Mechanical		500	500		500	500	500	500	
AC4	200 ~ 240 V		kW/A	19/80	22/93	30/125	37/150	45/185	50/200
	380 ~ 440 V			37/75	45/90	55/110	75/150	90/185	102/200
	Electrical Lifespan			10,000 times	3	3	3	3	3
Mounting Method			Screw Mounting			Screw Mounting			
Auxiliary Contact									
Standard			2NO2NC			2NO2NC			
Additional			2NO2NC			2NO2NC			
Dimensions	W×H×D	mm	103×155×145.1			138×204×174.2			

## 300 ~ 800 AF

Model Name			HGC300	HGC400	HGC500	HGC630	HGC800	
IEC 60947								
Rated Insulation Voltage [Ui]		V	1,000	1,000	1,000	1,000	1,000	
Rated Operational Voltage [Ue]		V	1,000	1,000	1,000	1,000	1,000	
Rated Impulse Withstand Voltage [Uimp]		kV	8	8	8	8	8	
Rated Thermal Current [Ith] (AC1)		A	400	500	550	750	900	
Rated frequency		Hz	50/60	50/60	50/60	50/60	50/60	
AC3	200 ~ 240 V		kW/A	90/300	125/400	140/500	190/630	220/800
	380 ~ 440 V			160/300	220/400	250/500	330/630	440/800
	500 ~ 550 V			200/273	250/300	300/426	330/500	500/720
	660 ~ 690 V			200/220	250/300	335/360	400/412	500/630
	1,000 V			200/141	250/178	275/192	300/213	400/284
	Lifespan	Electrical		10,000 times	100	100	50	50
Mechanical		500	500		500	500	500	
AC4	200 ~ 240 V		kW/A	55/220	75/300	90/350	110/400	160/630
	380 ~ 440 V			110/220	150/300	175/350	200/400	300/630
	Electrical Lifespan			10,000 times	3	3	3	3
Mounting Method			Screw Mounting			Screw Mounting		
Auxiliary Contact								
Standard			2NO2NC			2NO2NC		
Additional			2NO2NC			2NO2NC		
Dimensions	W×H×D	mm	163×243×203			276×314×255.3		

## Model Selection Table

### Thermal Overload Relay : 18 ~ 800 AF

#### 18 ~ 100 AF

Model Name (Basic)			HGT18		HGT40		HGT65		HGT100	
3- Pole, 2 Element			HGT18H		HGT40H		HGT65H		HGT100H	
3- Pole, 3 Element (Loss Phase Protection)			HGT18K		HGT40K		HGT65K		HGT100K	
Current	A		Nominal Rating	0.12 ~ 18	Nominal Rating	7 ~ 40	Nominal Rating	7 ~ 65	Nominal Rating	17 ~ 100
Setting Current (Min. ~ Max.)	A		0.18	0.12 ~ 0.18	10	7 ~ 10	10	7 ~ 10	25	17 ~ 25
			0.26	0.18 ~ 0.26	12	8 ~ 12	12	8 ~ 12	32	22 ~ 32
			0.35	0.25 ~ 0.35	18	12 ~ 18	18	12 ~ 18	40	28 ~ 40
			0.5	0.34 ~ 0.5	22	15 ~ 22	22	15 ~ 22	50	34 ~ 50
			0.7	0.5 ~ 0.7	25	17 ~ 25	25	17 ~ 25	65	45 ~ 65
			0.9	0.6 ~ 0.9	32	22 ~ 32	32	22 ~ 32	75	52 ~ 75
			1.2	0.8 ~ 1.2	40	28 ~ 40	40	28 ~ 40	85	59 ~ 85
			1.6	1.1 ~ 1.6			50	34 ~ 50	100	70 ~ 100
			2.1	1.5 ~ 2.1			65	45 ~ 65		
			3	2 ~ 3						
			4.2	2.8 ~ 4.2						
			5	3 ~ 5						
			6	4 ~ 6						
			8	5.6 ~ 8						
	9	6 ~ 9								
	12	8 ~ 12								
Auxiliary Contact			1NO1NC		1NO1NC		1NO1NC		1NO1NC	
Reset Method			Manual/Auto		Manual/Auto		Manual/Auto		Manual/Auto	
Dimensions	W×H×D	mm	45×78.2×82.7		45×80.7×95.5		55×89.3×110.7		70×105×128.1	

## 150 ~ 800 AF

Model Name (Basic)			HGT150		HGT265		HGT500		HGT800	
3- Pole, 2 Element			HGT150H		HGT265H		HGT500H		HGT800H	
3- Pole, 3 Element (Loss Phase Protection)			HGT150K		HGT265K		HGT500K		HGT800K	
Current	A		Nominal Rating	48 ~ 150	Nominal Rating	48 ~ 265	Nominal Rating	90 ~ 500	Nominal Rating	378 ~ 800
Setting Current (Min. ~ Max.)	A		80	48 ~ 80	80	48 ~ 80	150	90 ~ 150	630	378 ~ 630
			115	69 ~ 115	115	69 ~ 115	185	111 ~ 185	800	480 ~ 800
			130	78 ~ 130	130	78 ~ 130	225	135 ~ 225		
			150	90 ~ 150	150	90 ~ 150	265	159 ~ 265		
					185	111 ~ 185	300	180 ~ 300		
					225	135 ~ 225	400	240 ~ 400		
				265	159 ~ 265	500	300 ~ 500			
Auxiliary Contact			1NO1NC		1NO1NC		1NO1NC		1NO1NC	
Reset Method			Manual/Auto		Manual/Auto		Manual/Auto		Manual/Auto	
Dimensions	W×H×D	mm	180×159×179.3		180×185×179.3		180×205.2×179.3		245×197×209.9	

# Ratings and Order Code

## Magnetic Contactor : HGC 9 ~ 18 A

Rating		HGC			
Model Name		HGC9	HGC12	HGC18	
IEC 60947-4					
Rated Insulation Voltage [Ui]		V	800	800	
Rated Operational Voltage [Ue]		V	690	690	
Rated Impulse Withstand Voltage [Uimp]		kV	6	6	
Rated Thermal Current I <sub>th</sub> (AC1)		A	25	40	
AC3	200 ~ 240 V	kW/A	2.5/9	3.5/12	4.5/18
	380 ~ 440 V		4/9	5.5/12	7.5/18
	500 ~ 550 V		4/7	7.5/12	8.5/13
	660 ~ 690 V		4/6	7.5/9	7.5/9
	1,000 V		-	-	-
	Lifespan	Electrical	10,000 times	250	250
	Mechanical		1,500	1,500	1,500
AC4	200 ~ 240 V	kW/A	1.5/8	2.2/11	3.7/16
	380 ~ 440 V		2.2/6	4/9	4/11
	Electrical Lifespan	10,000 times	3	3	3
AC1, 2, 3 Load Permitted Operating Frequency/Time	100 % Load	Frequency	1,000	1,000	1,000
	50 % Load (DC)		2,000	2,000	2,000
	20 % Load (DC)		3,600	3,600	3,600
AC4 Load Permitted Operating Frequency/Time	100 % Load	Frequency	300	300	300
	50 % Load		600	600	600
Making Capacity	220 V	A	110	130	180
	440 V		90	120	180
Breaking Capacity	220 V	A	88	104	144
	440 V		72	96	144
Mounting Method		Screw & Rail Mounting			
Auxiliary Contact					
Standard	AC	1NO1NC or 2NO2NC			
	DC	1NO1NC or 2NO2NC			
	AC/DC	-			
Additional	AC	2NO2NC			
	DC	2NO2NC			
	AC/DC	-			
Dimensions					
AC	W×H×D	mm	45×94.2×91.1		
DC			45×94.2×124		
AC/DC			-		
Weight					
AC	kg	0.4			
DC		0.6			
AC/DC		-			
Contact Arrangement					
Main	Main Contact	3a			
	Auxiliary Contact	2a2b			
Main + Auxiliary Block Added (2a2b)	Main Contact	3a			
	Auxiliary Contact	4a4b			

※ For auxiliary contact usage, refer to Page 62 ~ 63.  
 When using auxiliary contact, Up to 6a can be made for A contact and up to 4b for B contact.  
 When using 4a4b condition by using side auxiliary block, upper auxiliary block cannot be used.  
 In the main 2a2b, upper auxiliary block can be used.

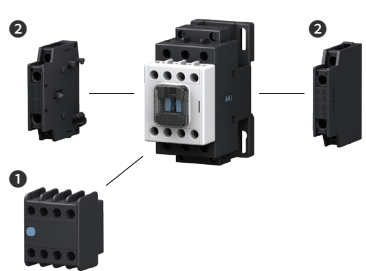
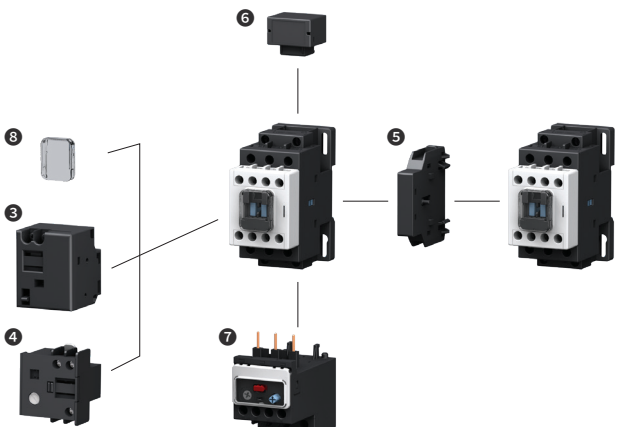

Accessories

Auxiliary Contacts	Other Accessories
	
<p>❶ Auxiliary Contact Block (Front Mounting) HGC TB - 62 page</p> <p>❷ Auxiliary Contact Block (Side Mounting) HGC SB 40 - 62 page</p>	<p>❸ Mechanical Latching Block HGC LB 100 - 65 page</p> <p>❹ Timer HGC ET - 67 page</p> <p>❺ Interlock Unit HGC IU 40 - 64 page</p> <p>❻ Surge Absorber HGC RC/CD 40 - 66 page</p> <p>❼ Thermal Overload Relay HGT 18 - 52 page</p> <p>❽ Front Safety Cover HGCFC 100 - 69 page</p>

Order Code

• Based on standard order (General type, with terminal cover), without accessories/  
Auxiliary contact : Based on 2NO2NC

Operational Voltage (V)		HGC9	HGC12	HGC18
AC (60 Hz)	24	HGC9 22NS A024	HGC12 22NS A024	HGC18 22NS A024
	48	HGC9 22NS A048	HGC12 22NS A048	HGC18 22NS A048
	110	HGC9 22NS A110	HGC12 22NS A110	HGC18 22NS A110
	120	HGC9 22NS A120	HGC12 22NS A120	HGC18 22NS A120
	220	HGC9 22NS A220	HGC12 22NS A220	HGC18 22NS A220
	240	HGC9 22NS A240	HGC12 22NS A240	HGC18 22NS A240
	380	HGC9 22NS A380	HGC12 22NS A380	HGC18 22NS A380
	440	HGC9 22NS A440	HGC12 22NS A440	HGC18 22NS A440
AC (50 Hz)	24	HGC9 22NS X024	HGC12 22NS X024	HGC18 22NS X024
	48	HGC9 22NS X048	HGC12 22NS X048	HGC18 22NS X048
	110	HGC9 22NS X110	HGC12 22NS X110	HGC18 22NS X110
	120	HGC9 22NS X120	HGC12 22NS X120	HGC18 22NS X120
	220	HGC9 22NS X220	HGC12 22NS X220	HGC18 22NS X220
	240	HGC9 22NS X240	HGC12 22NS X240	HGC18 22NS X240
	380	HGC9 22NS X380	HGC12 22NS X380	HGC18 22NS X380
	440	HGC9 22NS X440	HGC12 22NS X440	HGC18 22NS X440
DC	24	HGC9 22NS D024	HGC12 22NS D024	HGC18 22NS D024
	48	HGC9 22NS D048	HGC12 22NS D048	HGC18 22NS D048
	110	HGC9 22NS D110	HGC12 22NS D110	HGC18 22NS D110
	125	HGC9 22NS D125	HGC12 22NS D125	HGC18 22NS D125
	220	HGC9 22NS D220	HGC12 22NS D220	HGC18 22NS D220

# Ratings and Order Code

## Magnetic Contactor : HGC 25 ~ 40 A

Rating		HGC			
Model Name		HGC25	HGC32	HGC40	
IEC 60947					
Rated Insulation Voltage [Ui]		V	800	800	
Rated Operational Voltage [Ue]		V	690	690	
Rated Impulse Withstand Voltage [Uimp]		kV	6	6	
Rated Thermal Current I <sub>th</sub> (AC1)		A	45	55	
AC3	200 ~ 240 V	kW/A	5.5/25	7.5/32	11/40
	380 ~ 440 V		11/25	15/32	18.5/40
	500 ~ 550 V		15/22	18.5/28	22/32
	660 ~ 690 V		15/17	18.5/20	22/23
	1,000 V		-	-	-
	Lifespan	Electrical	10,000 times	250	200
	Mechanical		1,500	1,500	1,500
AC4	200 ~ 240 V	kW/A	3.7/18	4.5/22	5.5/25
	380 ~ 440 V		5.5/13	7.5/17	11/24
	Electrical Lifespan	10,000 times	3	3	3
AC1, 2, 3 Load Permitted Operating Frequency/Time	100 % Load	Frequency	1,000	1,000	1,000
	50 % Load (DC)		2,000	2,000	2,000
	20 % Load (DC)		3,600	3,600	3,600
AC4 Load Permitted Operating Frequency/Time	100 % Load	Frequency	300	300	250
	50 % Load		600	600	500
Making Capacity	220 V	A	250	320	400
	440 V		250	320	400
Breaking Capacity	220 V	A	200	256	320
	440 V		200	256	320
Mounting Method		Screw & Rail Mounting			
Auxiliary Contact					
Standard	AC	1NO1NC or 2NO2NC			
	DC	1NO1NC or 2NO2NC			
	AC/DC	-			
Additional	AC	2NO2NC			
	DC	2NO2NC			
	AC/DC	-			
Dimensions					
AC	W×H×D	mm	45×99.6×96.6		
DC			45×99.6×129.5		
AC/DC			-		
Weight					
AC	kg	0.5			
DC		0.65			
AC/DC		-			
Contact Arrangement					
Main	Main Contact	3a			
	Auxiliary Contact	2a2b			
Main + Auxiliary Block Added (2a2b)	Main Contact	3a			
	Auxiliary Contact	4a4b			

※ For auxiliary contact usage, refer to Page 62 ~ 63.  
 When using auxiliary contact, Up to 6a can be made for A contact and up to 4b for B contact.  
 When using 4a4b condition by using side auxiliary block, upper auxiliary block cannot be used.  
 In the main 2a2b, upper auxiliary block can be used.

Accessories

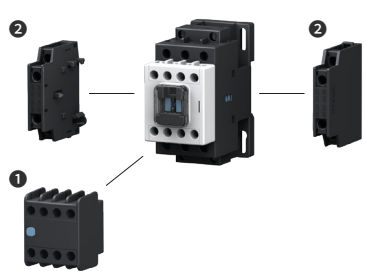
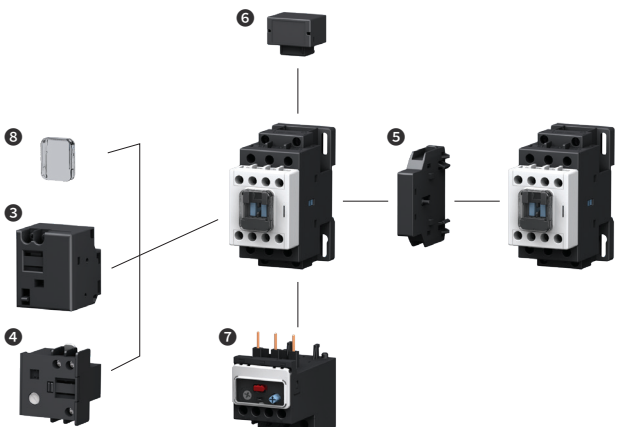
Auxiliary Contacts	Other Accessories		
			
<p>❶ Auxiliary Contact Block (Front Mounting) HGC TB - 62 page</p> <p>❷ Auxiliary Contact Block (Side Mounting) HGC SB 40 - 62 page</p>	<p>❸ Mechanical Latching Block HGC LB 100 - 65 page</p> <p>❹ Timer HGC ET - 67 page</p>	<p>❺ Interlock Unit HGC IU 40 - 64 page</p> <p>❻ Surge Absorber HGC RC/CD 40 - 66 page</p>	<p>❼ Thermal Overload Relay HGT 40 - 54 page</p> <p>❽ Front Safety Cover HGCFC 100 - 69 page</p>

Order Code

• Based on standard order (General type, with terminal cover), without accessories/  
Auxiliary contact : Based on 2NO2NC

Operational Voltage (V)		HGC25	HGC32	HGC40
AC (60 Hz)	24	HGC25 22NS A024	HGC32 22NS A024	HGC40 22NS A024
	48	HGC25 22NS A048	HGC32 22NS A048	HGC40 22NS A048
	110	HGC25 22NS A110	HGC32 22NS A110	HGC40 22NS A110
	120	HGC25 22NS A120	HGC32 22NS A120	HGC40 22NS A120
	220	HGC25 22NS A220	HGC32 22NS A220	HGC40 22NS A220
	240	HGC25 22NS A240	HGC32 22NS A240	HGC40 22NS A240
	380	HGC25 22NS A380	HGC32 22NS A380	HGC40 22NS A380
	440	HGC25 22NS A440	HGC32 22NS A440	HGC40 22NS A440
AC (50 Hz)	24	HGC25 22NS X024	HGC32 22NS X024	HGC40 22NS X024
	48	HGC25 22NS X048	HGC32 22NS X048	HGC40 22NS X048
	110	HGC25 22NS X110	HGC32 22NS X110	HGC40 22NS X110
	120	HGC25 22NS X120	HGC32 22NS X120	HGC40 22NS X120
	220	HGC25 22NS X220	HGC32 22NS X220	HGC40 22NS X220
	240	HGC25 22NS X240	HGC32 22NS X240	HGC40 22NS X240
	380	HGC25 22NS X380	HGC32 22NS X380	HGC40 22NS X380
	440	HGC25 22NS X440	HGC32 22NS X440	HGC40 22NS X440
DC	24	HGC25 22NS D024	HGC32 22NS D024	HGC40 22NS D024
	48	HGC25 22NS D048	HGC32 22NS D048	HGC40 22NS D048
	110	HGC25 22NS D110	HGC32 22NS D110	HGC40 22NS D110
	125	HGC25 22NS D125	HGC32 22NS D125	HGC40 22NS D125
	220	HGC25 22NS D220	HGC32 22NS D220	HGC40 22NS D220

# Ratings and Order Code

## Magnetic Contactor : HGC 50 ~ 65 A

Rating		HGC	
Model Name		HGC50	HGC65
IEC 60947			
Rated Insulation Voltage [Ui]		V	1,000
Rated Operational Voltage [Ue]		V	690
Rated Impulse Withstand Voltage [Uimp]		kV	8
Rated Thermal Current Ith (AC1)		A	70
AC3	200 ~ 240 V	kW/A	15/50
	380 ~ 440 V		22/50
	500 ~ 550 V		30/43
	660 ~ 690 V		30/28
	1,000 V		-
	Lifespan	Electrical	10,000 times
	Mechanical		1,500
AC4	200 ~ 240 V	kW/A	7.5/35
	380 ~ 440 V		15/32
	Electrical Lifespan	10,000 times	3
AC1, 2, 3 Load Permitted Operating Frequency/Time	100 % Load	Frequency	750
	50 % Load (DC)		1,500 (900)
	20 % Load (DC)		3,000 (1,200)
AC4 Load Permitted Operating Frequency/Time	100 % Load	Frequency	250
	50 % Load		500
Making Capacity	220 V	A	500
	440 V		500
Breaking Capacity	220 V	A	400
	440 V		400
Mounting Method		Screw & Rail Mounting	
Auxiliary Contact			
Standard	AC	2NO2NC	
	DC	2NO1NC	
	AC/DC	-	
Additional	AC	2NO2NC	
	DC	1NO1NC	
	AC/DC	-	
Dimensions			
AC	W×H×D	mm	55×127.6×129.1
DC			55×127.6×129.1
AC/DC			-
Weight			
AC	kg	0.8	
DC		0.8	
AC/DC		-	
Contact Arrangement			
Main	Main Contact	3a	
	Auxiliary Contact	2a2b	
Main + Auxiliary Block Added (2a2b)	Main Contact	3a	
	Auxiliary Contact	4a4b	

※ For auxiliary contact usage, refer to Page 62 ~ 63.  
 When using auxiliary contact, Up to 6a can be made for A contact and up to 4b for B contact.  
 When using 4a4b condition by using side auxiliary block, upper auxiliary block cannot be used.  
 In the main 2a2b, upper auxiliary block can be used.

Accessories

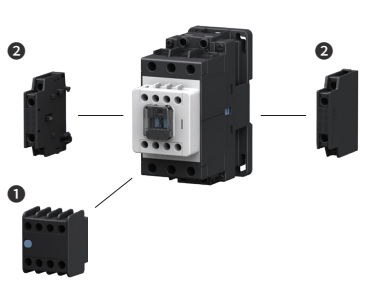
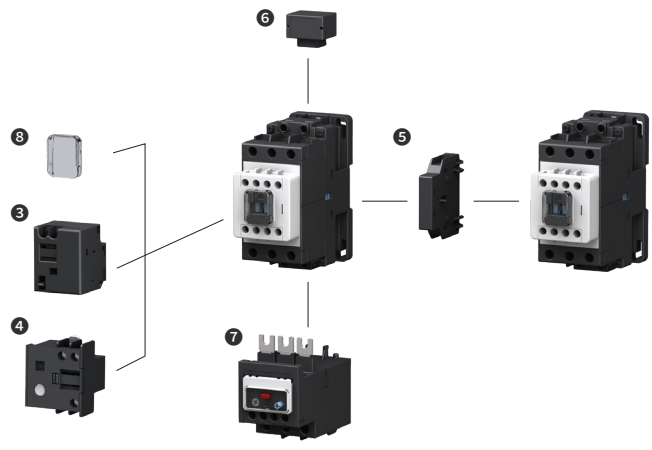
Auxiliary Contacts	Other Accessories
	
<p>❶ Auxiliary Contact Block (Front Mounting) HGC TB - 62 page</p> <p>❷ Auxiliary Contact Block (Side Mounting) HGC SB 100 - 62 page</p>	<p>❸ Mechanical Latching Block HGC LB 100 - 65 page</p> <p>❹ Timer HGC ET - 67 page</p> <p>❺ Interlock Unit HGC IU 100 - 64 page</p> <p>❻ Surge Absorber HGC RC/CD100 - 66 page</p> <p>❼ Thermal Overload Relay HGT 65 - 54 page</p> <p>❽ Front Safety Cover HGCFC 100 - 69 page</p>

Order Code

• Based on standard order (General type, with terminal cover), without accessories/  
Auxiliary contact : AC based on 2NO2NC, DC based on 2NO1NC

Operational Voltage (V)		HGC50	HGC65
AC (60 Hz)	24	HGC50 22NS A024	HGC65 22NS A024
	48	HGC50 22NS A048	HGC65 22NS A048
	110	HGC50 22NS A110	HGC65 22NS A110
	120	HGC50 22NS A120	HGC65 22NS A120
	220	HGC50 22NS A220	HGC65 22NS A220
	240	HGC50 22NS A240	HGC65 22NS A240
	380	HGC50 22NS A380	HGC65 22NS A380
	440	HGC50 22NS A440	HGC65 22NS A440
AC (50 Hz)	24	HGC50 22NS X024	HGC65 22NS X024
	48	HGC50 22NS X048	HGC65 22NS X048
	110	HGC50 22NS X110	HGC65 22NS X110
	120	HGC50 22NS X120	HGC65 22NS X120
	220	HGC50 22NS X220	HGC65 22NS X220
	240	HGC50 22NS X240	HGC65 22NS X240
	380	HGC50 22NS X380	HGC65 22NS X380
	440	HGC50 22NS X440	HGC65 22NS X440
DC	24	HGC50 21NS D024	HGC65 21NS D024
	48	HGC50 21NS D048	HGC65 21NS D048
	110	HGC50 21NS D110	HGC65 21NS D110
	125	HGC50 21NS D125	HGC65 21NS D125
	220	HGC50 21NS D220	HGC65 21NS D220

# Ratings and Order Code

## Magnetic Contactor : HGC 75 ~ 100 A

Rating		HGC			
Model Name		HGC75	HGC85	HGC100	
IEC 60947					
Rated Insulation Voltage [Ui]		V	1,000	1,000	
Rated Operational Voltage [Ue]		V	690	690	
Rated Impulse Withstand Voltage [Uimp]		kV	8	8	
Rated Thermal Current I <sub>th</sub> (AC1)		A	115	125	
AC3	200 ~ 240 V	kW/A	22/75	25/85	30/100
	380 ~ 440 V		37/75	45/85	55/100
	500 ~ 550 V		37/64	50/75	55/85
	660 ~ 690 V		37/42	45/45	50/65
	1,000 V		-	-	-
	Lifespan	Electrical	10,000 times	200	200
	Mechanical		1,000	1,000	1,000
AC4	200 ~ 240 V	kW/A	13/55	15/65	17/72
	380 ~ 440 V		25/52	30/62	33/68
	Electrical Lifespan	10,000 times	3	3	3
AC1, 2, 3 Load Permitted Operating Frequency/Time	100 % Load	Frequency	450	450	450
	50 % Load (DC)		900	900	900
	20 % Load (DC)		1,800	1,800	1,800
AC4 Load Permitted Operating Frequency/Time	100 % Load	Frequency	200	200	200
	50 % Load		400	400	400
Making Capacity	220 V	A	750	850	1,000
	440 V		750	850	1,000
Breaking Capacity	220 V	A	600	680	800
	440 V		600	680	800
Mounting Method		Screw & Rail Mounting			
Auxiliary Contact					
Standard	AC	2NO2NC			
	DC	2NO1NC			
	AC/DC	-			
Additional	AC	2NO2NC			
	DC	1NO1NC			
	AC/DC	-			
Dimensions					
AC	W×H×D	mm	70×146×153		
DC			70×146×153		
AC/DC			-		
Weight					
AC	kg	1.3			
DC		1.3			
AC/DC		-			
Contact Arrangement					
Main	Main Contact	3a			
	Auxiliary Contact	2a2b			
Main + Auxiliary Block Added (2a2b)	Main Contact	3a			
	Auxiliary Contact	4a4b			

※ For auxiliary contact usage, refer to Page 62 ~ 63.  
 When using auxiliary contact, Up to 6a can be made for A contact and up to 4b for B contact.  
 When using 4a4b condition by using side auxiliary block, upper auxiliary block cannot be used.  
 In the main 2a2b, upper auxiliary block can be used.

Accessories

Auxiliary Contacts	Other Accessories
<p>❶ Auxiliary Contact Block (Front Mounting) HGC TB - 62 page</p> <p>❷ Auxiliary Contact Block (Side Mounting) HGC SB 100 - 62 page</p>	<p>❸ Mechanical Latching Block HGC LB 100 - 65 page</p> <p>❹ Timer HGC ET - 67 page</p> <p>❺ Interlock Unit HGC IU 100 - 64 page</p> <p>❻ Surge Absorber HGC RC/CD100 - 66 page</p> <p>❼ Thermal Overload Relay HGT 65 - 54 page</p> <p>❽ Front Safety Cover HGCFC 100 - 69 page</p>

Order Code

• Based on standard order (General type, with terminal cover), without accessories/  
Auxiliary contact : AC based on 2NO2NC, DC based on 2NO1NC

Operational Voltage(V)		HGC75	HGC85	HG100
AC (60 Hz)	24	HGC75 22NS A024	HGC85 22NS A024	HGC100 22NS A024
	48	HGC75 22NS A048	HGC85 22NS A048	HGC100 22NS A048
	110	HGC75 22NS A110	HGC85 22NS A110	HGC100 22NS A110
	120	HGC75 22NS A120	HGC85 22NS A120	HGC100 22NS A120
	220	HGC75 22NS A220	HGC85 22NS A220	HGC100 22NS A220
	240	HGC75 22NS A240	HGC85 22NS A240	HGC100 22NS A240
	380	HGC75 22NS A380	HGC85 22NS A380	HGC100 22NS A380
	440	HGC75 22NS A440	HGC85 22NS A440	HGC100 22NS A440
AC (50 Hz)	24	HGC75 22NS X024	HGC85 22NS X024	HGC100 22NS X024
	48	HGC75 22NS X048	HGC85 22NS X048	HGC100 22NS X048
	110	HGC75 22NS X110	HGC85 22NS X110	HGC100 22NS X110
	120	HGC75 22NS X120	HGC85 22NS X120	HGC100 22NS X120
	220	HGC75 22NS X220	HGC85 22NS X220	HGC100 22NS X220
	240	HGC75 22NS X240	HGC85 22NS X240	HGC100 22NS X240
	380	HGC75 22NS X380	HGC85 22NS X380	HGC100 22NS X380
	440	HGC75 22NS X440	HGC85 22NS X440	HGC100 22NS X440
DC	24	HGC75 21NS D024	HGC85 21NS D024	HGC100 21NS D024
	48	HGC75 21NS D048	HGC85 21NS D048	HGC100 21NS D048
	110	HGC75 21NS D110	HGC85 21NS D110	HGC100 21NS D110
	125	HGC75 21NS D125	HGC85 21NS D125	HGC100 21NS D125
	220	HGC75 21NS D220	HGC85 21NS D220	HGC100 21NS D220

# Ratings and Order Code

## Magnetic Contactor : HGC 115 ~ 150 A

Rating				HGC		
Model Name				HGC115	HGC130	HGC150
IEC 60947-4						
Rated Insulation Voltage [Ui]		V		1,000	1,000	1,000
Rated Operational Voltage [Ue]		V		1,000	1,000	1,000
Rated Impulse Withstand Voltage [Uimp]		kV		8	8	8
Rated Thermal Current Ith (AC1)		A		160	180	210
AC3	200 ~ 240 V		kW/A	37/115	40/130	45/150
	380 ~ 440 V			60/115	65/130	75/150
	500 ~ 550 V			59/100	70/120	90/140
	660 ~ 690 V			55/65	75/82	90/120
	1,000 V			65/50	75/54	90/66
	Lifespan	Electrical	10,000 times	100	100	100
	Mechanical	500		500	500	
AC4	200 ~ 240 V		kW/A	19/80	22/93	30/125
	380 ~ 440 V			37/75	45/90	55/110
	Electrical Lifespan		10,000 times	3	3	3
AC1, 2, 3 Load Permitted Operating Frequency/Time	100 % Load		Frequency	450	450	450
	50 % Load (DC)			900	900	900
	20 % Load (DC)			1,800	1,800	1,800
AC4 Load Permitted Operating Frequency/Time	100 % Load		Frequency	200	200	200
	50 % Load			400	400	400
Making Capacity	220 V		A	1,150	1,300	1,500
	440 V			1,150	1,300	1,500
Breaking Capacity	220 V		A	920	1,040	1,200
	440 V			920	1,040	1,200
Mounting Method				Screw Mounting		
Auxiliary Contact						
Standard		AC/DC		2NO2NC		
Additional <sup>1)</sup>		AC/DC		2NO2NC		
Dimensions		AC/DC	W×H×D	mm		
Weight		AC/DC		kg		
				103×155×145.1		
				2.7		
Contact Arrangement						
Main	Main Contact	3a				
	Auxiliary Contact	2a2b				
Main + Auxiliary Block Added (2a2b)	Main Contact	3a				
	Auxiliary Contact	4a4b				

1) Maximum number of auxiliary contact that can be mounted horizontally on the side.

※ For auxiliary contact usage, refer to Page 62 ~ 63.

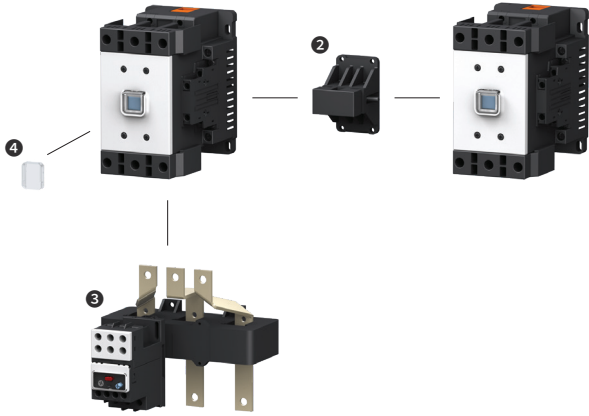

Accessories

Auxiliary Contacts	Other Accessories			
				
<p>❶ Auxiliary Contact Block (Side Mounting) HGC SB 800 - 62 page</p>	<p>❷ Interlock Unit HGC IU 265 - 64 page</p>	<p>❸ Thermal Overload Relay HGT 150 - 56 page</p>	<p>❹ Front Safety Cover HGCFC 150 - 69 page</p>	

Order Code

• Based on standard order (General type, with terminal cover), without accessories/  
Auxiliary contact : Based on 2NO2NC

Nominal Voltage (V)	Operational Voltage (V)	HGC115	HGC130	HGC150
220	AC 100 ~ 240 DC 110 ~ 220	HGC115 22NS F220	HGC130 22NS F220	HGC150 22NS F220
440	AC 380 ~ 450	HGC115 22NS F440	HGC130 22NS F440	HGC150 22NS F440

# Ratings and Order Code

## Magnetic Contactor : HGC 185 ~ 265 A

Rating				HGC		
Model Name				HGC185	HGC225	HGC265
IEC 60947						
Rated Insulation Voltage [Ui]		V		1,000	1,000	1,000
Rated Operational Voltage [Ue]		V		1,000	1,000	1,000
Rated Impulse Withstand Voltage [Uimp]		kV		8	8	8
Rated Thermal Current Ith (AC1)		A		275	315	350
AC3	200 ~ 240 V		kW/A	55/185	75/225	80/265
	380 ~ 440 V			90/185	132/225	147/265
	500 ~ 550 V			110/180	132/200	150/225
	660 ~ 690 V			110/120	132/150	160/173
	1,000 V			110/78	132/96	160/113
	Lifespan	Electrical	10,000 times	100	100	100
	Mechanical	500		500	500	
AC4	200 ~ 240 V		kW/A	37/150	45/185	50/200
	380 ~ 440 V			75/150	90/185	102/200
	Electrical Lifespan		10,000 times	3	3	3
AC1, 2, 3 Load Permitted Operating Frequency/Time	100 % Load		Frequency	300	300	300
	50 % Load (DC)			600	600	600
	20 % Load (DC)			1,200	1,200	1,200
AC4 Load Permitted Operating Frequency/Time	100 % Load		Frequency	200	200	200
	50 % Load			400	400	400
Making Capacity	220 V		A	1,850	2,250	2,650
	440 V			1,850	2,250	2,650
Breaking Capacity	220 V		A	1,480	1,800	2,120
	440 V			1,480	1,800	2,120
Mounting Method				Screw Mounting		
Auxiliary Contact						
Standard		AC/DC		2NO2NC		
Additional <sup>1)</sup>		AC/DC		2NO2NC		
Dimensions		AC/DC	W×H×D	mm		
Weight		AC/DC		kg		
				138×204×174.2		
				4.8		
Contact Arrangement						
Main	Main Contact	3a				
	Auxiliary Contact	2a2b				
Main + Auxiliary Block Added (2a2b)	Main Contact	3a				
	Auxiliary Contact	4a4b				

1) Maximum number of auxiliary contact that can be mounted horizontally on the side.

※ For auxiliary contact usage, refer to Page 62 ~ 63.

Accessories

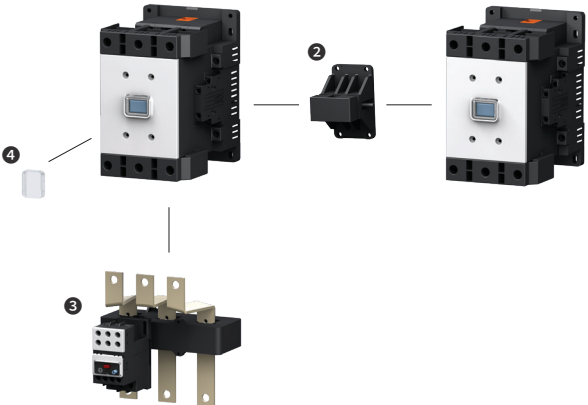
Auxiliary Contacts	Other Accessories			
				
<p>❶ Auxiliary Contact Block (Side Mounting) HGC SB 800 - 62 page</p>	<p>❷ Interlock Unit HGC IU 265 - 64 page</p>	<p>❸ Thermal Overload Relay HGT 265 - 56 page</p>	<p>❹ Front Safety Cover HGCFC 265 - 69 page</p>	

Order Code

• Based on standard order (General type, with terminal cover), without accessories/  
Auxiliary contact : Based on 2NO2NC

Nominal Voltage (V)	Operational Voltage (V)	HGC185	HGC225	HGC265
220	AC 100 ~ 240 DC 110 ~ 220	HGC185 22NS F220	HGC225 22NS F220	HGC265 22NS F220
440	AC 380 ~ 450	HGC185 22NS F440	HGC225 22NS F440	HGC265 22NS F440

# Ratings and Order Code

## Magnetic Contactor : HGC 300 ~ 500 A

Rating				HGC		
Model Name				HGC300	HGC400	HGC500
IEC 60947-4						
Rated Insulation Voltage [Ui]		V		1,000	1,000	1,000
Rated Operational Voltage [Ue]		V		1,000	1,000	1,000
Rated Impulse Withstand Voltage [Uimp]		kV		8	8	8
Rated Thermal Current Ith (AC1)		A		400	500	550
AC3	200 ~ 240 V		kW/A	90/300	125/400	140/500
	380 ~ 440 V			160/300	220/400	250/500
	500 ~ 550 V			200/273	250/300	300/426
	660 ~ 690 V			200/220	250/300	335/360
	1,000 V			200/141	250/178	275/192
	Lifespan	Electrical	10,000 times	100	100	50
	Mechanical	500		500	500	
AC4	200 ~ 240 V		kW/A	55/220	75/300	90/350
	380 ~ 440 V			110/220	150/300	175/350
	Electrical Lifespan		10,000 times	3	3	3
AC1, 2, 3 Load Permitted Operating Frequency/Time	100 % Load		Frequency	300	300	300
	50 % Load (DC)			600	600	600
	20 % Load (DC)			1,200	1,200	1,200
AC4 Load Permitted Operating Frequency/Time	100 % Load		Frequency	150	150	150
	50 % Load			300	300	300
Making Capacity	220 V		A	3,000	4,000	5,000
	440 V			3,000	4,000	5,000
Breaking Capacity	220 V		A	2,400	3,200	4,000
	440 V			2,400	3,200	4,000
Mounting Method				Screw Mounting		
Auxiliary Contact						
Standard		AC/DC		2NO2NC		
Additional <sup>1)</sup>		AC/DC		2NO2NC		
Dimensions		AC/DC	W×H×D	mm		
Weight		AC/DC		kg		
				163×243×203		
				9.2		
Contact Arrangement						
Main	Main Contact	3a				
	Auxiliary Contact	2a2b				
Main + Auxiliary Block Added (2a2b)	Main Contact	3a				
	Auxiliary Contact	4a4b				

<sup>1)</sup> Maximum number of auxiliary contact that can be mounted horizontally on the side.

※ For auxiliary contact usage, refer to Page 62 ~ 63.

Accessories

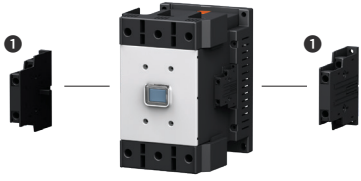
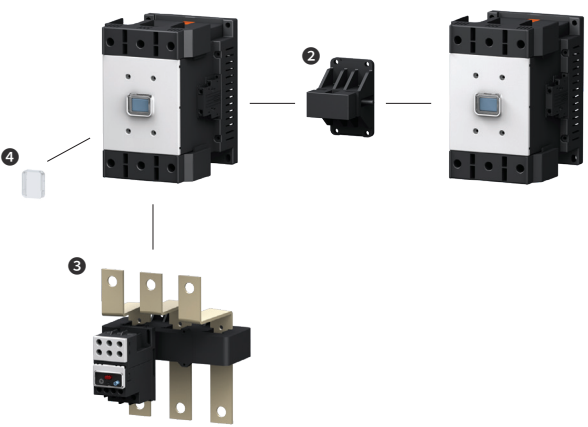
Auxiliary Contacts	Other Accessories			
				
<p>❶ Auxiliary Contact Block (Side Mounting) HGC SB 800 - 62 page</p>	<p>❷ Interlock Unit HGC IU 800 - 64 page</p>	<p>❸ Thermal Overload Relay HGT 500 - 56 page</p>	<p>❹ Front Safety Cover HGFCF 500 - 69 page</p>	

Order Code

• Based on standard order (General type, with terminal cover), without accessories/  
Auxiliary contact : Based on 2NO2NC

Nominal Voltage (V)	Operational Voltage (V)	HGC300	HGC400	HGC500
220	AC 100 ~ 240 DC 110 ~ 220	HGC300 22NS F220	HGC400 22NS F220	HGC500 22NS F220
440	AC 380 ~ 450	HGC300 22NS F440	HGC400 22NS F440	HGC500 22NS F440

# Ratings and Order Code

## Magnetic Contactor : HGC 630 ~ 800 A

Rating				HGC	
Model Name				HGC630	HGC800
IEC 60947-4					
Rated Insulation Voltage [Ui]		V		1,000	1,000
Rated Operational Voltage [Ue]		V		1,000	1,000
Rated Impulse Withstand Voltage [Uimp]		kV		8	8
Rated Thermal Current Ith (AC1)		A		750	900
AC3	200 ~ 240 V		kW/A	190/630	220/800
	380 ~ 440 V			330/630	440/800
	500 ~ 550 V			330/500	500/720
	660 ~ 690 V			400/412	500/630
	1,000 V			300/213	400/284
	Lifespan	Electrical	10,000 times	50	50
	Mechanical	500		500	
AC4	200 ~ 240 V		kW/A	110/400	160/630
	380 ~ 440 V			200/400	300/630
	Electrical Lifespan		10,000 times	3	3
AC1, 2, 3 Load Permitted Operating Frequency/Time	100 % Load		Frequency	300	300
	50 % Load (DC)			600	600
	20 % Load (DC)			1,200	1,200
AC4 Load Permitted Operating Frequency/Time	100 % Load		Frequency	150	150
	50 % Load			300	300
Making Capacity	220 V		A	6,300	8,000
	440 V			6,300	8,000
Breaking Capacity	220 V		A	5,040	6,400
	440 V			5,040	6,400
Mounting Method				Screw Mounting	
Auxiliary Contact					
Standard		AC/DC		2NO2NC	
Additional <sup>1)</sup>		AC/DC		2NO2NC	
Dimensions		AC/DC	W×H×D	mm	
Weight		AC/DC		kg	
				276×314×255.3	
				25	
Contact Arrangement					
Main	Main Contact	3a			
	Auxiliary Contact	2a2b			
Main + Auxiliary Block Added (2a2b)	Main Contact	3a			
	Auxiliary Contact	4a4b			

1) Maximum number of auxiliary contact that can be mounted horizontally on the side.

※ For auxiliary contact usage, refer to Page 62 ~ 63.

Accessories

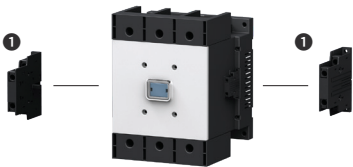
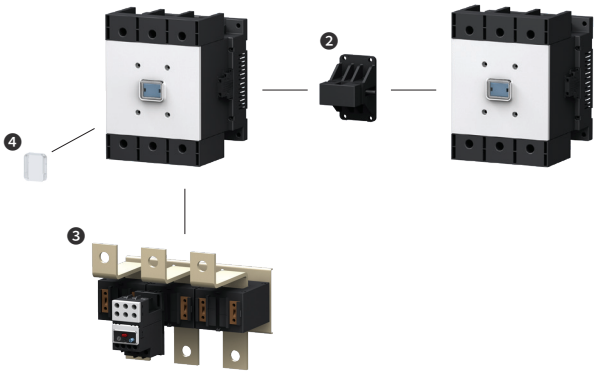
Auxiliary Contacts	Other Accessories			
				
<p>❶ Auxiliary Contact Block (Side Mounting) HGC SB 800 - 62 page</p>	<p>❷ Interlock Unit HGC IU 800 - 64 page</p>	<p>❸ Thermal Overload Relay HGT 800 - 56 page</p>	<p>❹ Front Safety Cover HGFCF 800 - 69 page</p>	

Order Code

• Based on standard order (General type, with terminal cover), without accessories/  
Auxiliary contact : Based on 2NO2NC

Nominal Voltage (V)	Operational Voltage (V)	HGC630		HGC800	
110	AC 100 ~ 127 DC 100 ~ 110	HGC630 22NS F110		HGC800 22NS F110	
220	AC 200 ~ 240 DC 200 ~ 220	HGC630 22NS F220		HGC800 22NS F220	
440	AC 380 ~ 450	HGC630 22NS F440		HGC800 22NS F440	

## Ratings and Order Code

### Thermal Overload Relay (TOR)

Exterior and Name of Basic Model		Ratings							
Exterior	Model Name	Nominal Current	Current (A)			Applicable Cable (mm <sup>2</sup> )		Aux. Contact	Applicable Magnetic Contactor
			Setting Current			Main Circuit	Aux. Circuit		
			Min.	Mid.	Max.				
 <p>Dimensions (mm) : 45 (W) × 82.7 (H) × 78.2 (D) Weight (kg) : 0.12</p>	HGT18	0.18	0.12	0.15	0.18	1 ~ 2.5	1 ~ 2.5	1NO1NC	HGC9 HGC12 HGC18
		0.26	0.18	0.22	0.26				
		0.35	0.25	0.3	0.35				
		0.5	0.34	0.42	0.5				
		0.7	0.5	0.6	0.7				
		0.9	0.6	0.75	0.9				
		1.2	0.8	1	1.2				
		1.6	1.1	1.35	1.6				
		2.1	1.5	1.8	2.1				
		3	2	2.5	3				
		4.2	2.8	3.5	4.2				
		5	3	4	5				
		6	4	5	6				
		8	5.6	6.8	8				
		9	6	7.5	9				
12	8	10	12						
18	12	15	18						

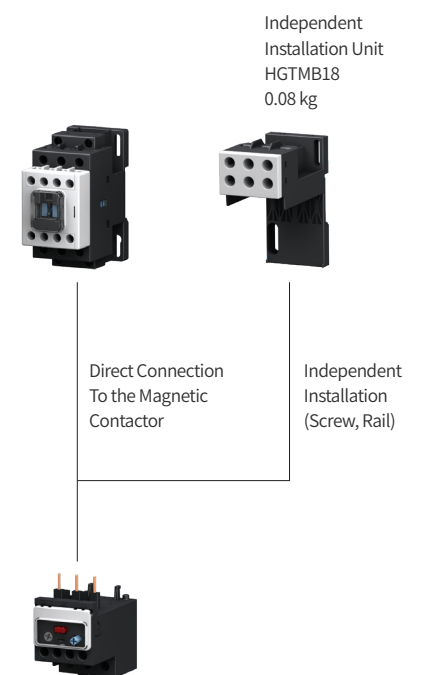

Order Code		Accessory Independent Installation Unit	Remark
Thermal Overload Relay (Protection Grade 10 A)			Installation Method
Screw Type Terminal (With Terminal Cover)			Connect directly to the magnetic contactor or use separate installation panel for independent installation.
K-Type (3-Pole, 3 Elements)	H-Type (3-Pole, 2 Elements)		
HGT18K A0P18S	HGT18H A0P18S	HGTMB18	
HGT18K A0P26S	HGT18H A0P26S		
HGT18K A0P35S	HGT18H A0P35S		
HGT18K A0P50S	HGT18H A0P50S		
HGT18K A0P70S	HGT18H A0P70S		
HGT18K A0P90S	HGT18H A0P90S		
HGT18K A1P20S	HGT18H A1P20S		
HGT18K A1P60S	HGT18H A1P60S		
HGT18K A2P10S	HGT18H A2P10S		
HGT18K A0003S	HGT18H A0003S		
HGT18K A4P20S	HGT18H A4P20S		
HGT18K A0005S	HGT18H A0005S		
HGT18K A0006S	HGT18H A0006S		
HGT18K A0008S	HGT18H A0008S		
HGT18K A0009S	HGT18H A0009S		
HGT18K A0012S	HGT18H A0012S		
HGT18K A0018S	HGT18H A0018S		

## Ratings and Order Code

### Thermal Overload Relay (TOR)

Exterior and Name of Basic Model		Ratings							
Exterior	Model Name	Current (A)				Applicable Cable (mm <sup>2</sup> )		Aux. Contact	Applicable Magnetic Contactor
		Nominal Current	Setting Current			Main Circuit	Aux. Circuit		
			Min.	Mid.	Max.				
 <p>Dimensions (mm) : 45 (W) × 95.5 (H) × 69.4 (D) Weight (kg) : 0.16</p>	HGT40	10	7	8.5	10	2 ~ 10	1 ~ 2.5	1NO1NC	HGC25 HGC32 HGC40
		12	8	10	12				
		18	12	15	18				
		22	15	18.5	22				
		25	17	21	25				
		32	22	27	32				
		40	28	34	40				
 <p>Dimensions (mm) : 55 (W) × 110.7 (H) × 89.3 (D) Weight (kg) : 0.29</p>	HGT65	10	7	8.5	10	2 ~ 25	1 ~ 2.5	1NO1NC	HGC50 HGC65
		12	8	10	12				
		18	12	15	18				
		22	15	18.5	22				
		25	17	21	25				
		32	22	27	32				
		40	28	34	40				
		50	34	42	50				
 <p>Dimensions (mm) : 70 (W) × 128.1 (H) × 105 (D) Weight (kg) : 0.47</p>	HGT100	25	17	21	25	6 ~ 38	1 ~ 2.5	1NO1NC	HGC75 HGC85 HGC100
		32	22	27	32				
		40	28	34	40				
		50	34	42	50				
		65	45	55	65				
		75	52	63	75				
		85	59	72	85				
		100	70	85	100				

Order Code		Accessory Independent Installation Unit	Remark
Thermal Overload Relay (Protection Grade 10 A)			Installation Method
Screw Type Terminal (With Terminal Cover)			
K-Type (3-Pole, 3 Elements)	H-Type (3-Pole, 2 Elements)		Connect directly to the magnetic contactor or use separate installation panel for independent installation.
HGT40K A0010S	HGT40H A0010S	HGTMB40	<p>Independent Installation Unit                      HGTMB40 (0.10 kg)                      HGTMB65 (0.12 kg)                      HGTMB100 (0.2 kg)</p>
HGT40K A0012S	HGT40H A0012S		
HGT40K A0018S	HGT40H A0018S		
HGT40K A0022S	HGT40H A0022S		
HGT40K A0025S	HGT40H A0025S		
HGT40K A0032S	HGT40H A0032S		
HGT40K A0040S	HGT40H A0040S		
HGT65K A0010S	HGT65H A0010S	HGTMB65	
HGT65K A0012S	HGT65H A0012S		
HGT65K A0018S	HGT65H A0018S		
HGT65K A0022S	HGT65H A0022S		
HGT65K A0025S	HGT65H A0025S		
HGT65K A0032S	HGT65H A0032S		
HGT65K A0040S	HGT65H A0040S		
HGT65K A0050S	HGT65H A0050S	HGTMB100	
HGT65K A0065S	HGT65H A0065S		
HGT100K A0025S	HGT100H A0025S		
HGT100K A0032S	HGT100H A0032S		
HGT100K A0040S	HGT100H A0040S		
HGT100K A0050S	HGT100H A0050S		
HGT100K A0065S	HGT100H A0065S		
HGT100K A0075S	HGT100H A0075S		
HGT100K A0085S	HGT100H A0085S		
HGT100K A00100S	HGT100H A00100S		

VCB

ACB





MCCB

MS

RELAY

# Ratings and Order Code

## Thermal Overload Relay (TOR)

Exterior and Name of Basic Model		Ratings							
Exterior	Model Name	Current (A)					Applicable Cable (mm <sup>2</sup> )		Applicable Magnetic Contactor
		Nominal Current	Setting Current			CT Ratio	Aux. Circuit	Aux. Contact	
			Min.	Mid.	Max.				
 <p>Dimensions (mm) : 180 (W) × 179.3 (H) × 159 (D) Weight (kg) : 2.0</p>	HGT150	80	48	64	80	80 : 5	1 ~ 2.5	1NO1NC	HGC115 HGC130 HGC150
		115	69	92	115	115 : 5			
		130	78	104	130	130 : 5			
		150	90	120	150	150 : 5			
 <p>Dimensions (mm) : 180 (W) × 179.3 (H) × 185 (D) Weight (kg) : 2.2</p>	HGT265	80	48	64	80	80 : 5	1 ~ 2.5	1NO1NC	HGC185 HGC225 HGC265
		115	69	92	115	115 : 5			
		130	78	104	130	130 : 5			
		150	90	120	150	150 : 5			
		185	111	148	185	185 : 5			
		225	135	180	225	225 : 5			
		265	159	212	265	265 : 5			
 <p>Dimensions (mm) : 180 (W) × 179.3 (H) × 205.2 (D) Weight (kg) : 2.4</p>	HGT500	150	90	120	150	150 : 5	1 ~ 2.5	1NO1NC	HGC300 HGC400 HGC500
		185	111	148	185	185 : 5			
		225	135	180	225	225 : 5			
		265	159	212	265	265 : 5			
		300	180	240	300	300 : 5			
		400	240	320	400	400 : 5			
		500	300	400	500	500 : 5			
 <p>Dimensions (mm) : 245 (W) × 209.9 (H) × 197 (D) Weight (kg) : 6.2</p>	HGT800	630	378	504	630	630 : 5	1 ~ 2.5	1NO1NC	HGC630 HGC800
		800	480	640	800	800 : 5			

Order Code		Remark	
Thermal Overload Relay (Protection Grade 10 A)		Installation Method	
Screw Type Terminal (With Terminal Cover)		Direct connection to the magnetic contactor	
K-Type (3-Pole, 3 Elements)	H-Type (3-Pole, 2 Elements)		
HGT150K A0080S	HGT150H A0080S		
HGT150K A0115S	HGT150H A0115S		
HGT150K A0130S	HGT150H A0130S	HGC115 HGC130 HGC150	HGC185 HGC225 HGC265
HGT150K A0150S	HGT150H A0150S		
HGT265K A0080S	HGT265H A0080S		
HGT265K A0115S	HGT265H A0115S		
HGT265K A0130S	HGT265H A0130S		
HGT265K A0150S	HGT265H A0150S		
HGT265K A0185S	HGT265H A0185S		
HGT265K A0225S	HGT265H A0225S		
HGT265K A0265S	HGT265H A0265S		
HGT500K A0150S	HGT500H A0150S	HGC300 HGC400 HGC500	HGC630 HGC800
HGT500K A0185S	HGT500H A0185S		
HGT500K A0225S	HGT500H A0225S		
HGT500K A0265S	HGT500H A0265S		
HGT500K A0300S	HGT500H A0300S		
HGT500K A0400S	HGT500H A0400S		
HGT500K A0500S	HGT500H A0500S		
HGT800K A0630S	HGT800H A0630S		
HGT800K A0800S	HGT800H A0800S		



# Ratings and Order Code

## Control Relay (HGR)

Rating		HGR	
Model Name		HGR-N (AC)	HGR-P (DC) Permanent Magnetic
<b>Rated Insulation Voltage [Ui]</b>			
IEC 60947	V		AC 750
VDE0660	V		AC 1,000
Rated Thermal Current I <sub>th</sub> (AC1)	A		16
<b>Rating</b>			
AC15	220 V	A	4
	380 V		3
	440 V		3
	500 V		2
	690 V		2
DC12 (Resistive Load)	24 V		4
	48 V		2.5
	125 V		1.1
	250 V		0.3
DC13 (Coil Load)	24 V		4
	48 V		2.5
	125 V		1.1
	250 V		0.3
UL/CSA <sup>1)</sup>	AC 120 V		6
	AC 240 V		3
	DC 125 V	1.1	
	DC 250 V	0.3	
Mechanical Lifespan	10,000 times	1,500	1,000
Applicable Cable Size for Connection	mm <sup>2</sup>		2×0.75-2.5
Operating Frequency	times/hr	3,000	1,800
<b>Maximum Fuse Rating</b>			
Plug-Fuse (Fast/Slow)			35/25
MCB-C Characteristics	A		16
HRC Fuse (DIN/BS88)			25
Mounting Method		Screw & Rail Mounting	
Contact		4NC	
		1NO + 3NC	
		2NO + 2NC	
		3NO + 1NC	
		4NO	
<b>Coil Power Consumption</b>			
AC (60 Hz)	Inrush	VA/W	80/64
	Normal		8/2.5
DC	Inrush/Normal	W	- / 5
<b>Dimensions</b>			
A/C	W×H×D	mm	44×75×80
D/C			-
			44×75×98.3
<b>Weight</b>			
AC	kg		0.3
DC			- / 0.45

※ 1) Contact Rating Code : A300 ~ P150

As for permanent magnetic type of HGR-P products, attention is required with regards to +, - polarity during the wiring of the coil terminal part.

## Operation Features

Model Name		HGR-N (220 Vac, 60 Hz)				HGR-P (110 Vdc)			
		22	40	44	80	22	40	44	80
Operational Voltage (V)	Intake	120 ~ 170	120 ~ 170	120 ~ 170	120 ~ 170	65 ~ 70	70 ~ 75	65 ~ 70	75 ~ 80
	Release	70 ~ 110	70 ~ 110	70 ~ 110	70 ~ 110	12 ~ 15	15 ~ 18	12 ~ 15	15 ~ 20
Operation Time (ms)	Coil On → NO Contact On	15 ~ 25	15 ~ 25	15 ~ 25	15 ~ 25	45 ~ 55	65 ~ 75	50 ~ 60	65 ~ 75
	Coil On → NC Contact Off	10 ~ 25		10 ~ 25		40 ~ 50		40 ~ 50	
	Coil Off → NO Contact Off	5 ~ 25	5 ~ 25	5 ~ 25	5 ~ 25	20 ~ 30	10 ~ 20	20 ~ 30	10 ~ 20
	Coil Off → NC Contact On	10 ~ 25		10 ~ 25		25 ~ 35		25 ~ 35	

### Order Code

Model Name	Contact Arrangement					
	4NC	1NO + 3NC	2NO + 2NC	3NO + 1NC	4NO	
AC 60 Hz	24	HGR 04NS A024	HGR 13NS A024	HGR 22NS A024	HGR 31NS A024	HGR 40NS A024
	48	HGR 04NS A048	HGR 13NS A048	HGR 22NS A048	HGR 31NS A048	HGR 40NS A048
	110	HGR 04NS A110	HGR 13NS A110	HGR 22NS A110	HGR 31NS A110	HGR 40NS A110
	120	HGR 04NS A120	HGR 13NS A120	HGR 22NS A120	HGR 31NS A120	HGR 40NS A120
	220	HGR 04NS A220	HGR 13NS A220	HGR 22NS A220	HGR 31NS A220	HGR 40NS A220
	240	HGR 04NS A240	HGR 13NS A240	HGR 22NS A240	HGR 31NS A240	HGR 40NS A240
	380	HGR 04NS A380	HGR 13NS A380	HGR 22NS A380	HGR 31NS A380	HGR 40NS A380
	440	HGR 04NS A440	HGR 13NS A440	HGR 22NS A440	HGR 31NS A440	HGR 40NS A440
	480	HGR 04NS A480	HGR 13NS A480	HGR 22NS A480	HGR 31NS A480	HGR 40NS A480
AC 50 Hz	24	HGR 04NS X024	HGR 13NS X024	HGR 22NS X024	HGR 31NS X024	HGR 40NS X024
	48	HGR 04NS X048	HGR 13NS X048	HGR 22NS X048	HGR 31NS X048	HGR 40NS X048
	110	HGR 04NS X110	HGR 13NS X110	HGR 22NS X110	HGR 31NS X110	HGR 40NS X110
	220	HGR 04NS X220	HGR 13NS X220	HGR 22NS X220	HGR 31NS X220	HGR 40NS X220
	240	HGR 04NS X240	HGR 13NS X240	HGR 22NS X240	HGR 31NS X240	HGR 40NS X240
	380	HGR 04NS X380	HGR 13NS X380	HGR 22NS X380	HGR 31NS X380	HGR 40NS X380
	400	HGR 04NS X400	HGR 13NS X400	HGR 22NS X400	HGR 31NS X400	HGR 40NS X400
	440	HGR 04NS X440	HGR 13NS X440	HGR 22NS X440	HGR 31NS X440	HGR 40NS X440
	DC Permanent Magnetic	24	HGR 04PS D024	HGR 13PS D024	HGR 22PS D024	HGR 31PS D024
48		HGR 04PS D048	HGR 13PS D048	HGR 22PS D048	HGR 31PS D048	HGR 40PS D048
110		HGR 04PS D110	HGR 13PS D110	HGR 22PS D110	HGR 31PS D110	HGR 40PS D110
125		HGR 04PS D125	HGR 13PS D125	HGR 22PS D125	HGR 31PS D125	HGR 40PS D125
220		HGR 04PS D220	HGR 13PS D220	HGR 22PS D220	HGR 31PS D220	HGR 40PS D220
Contact Arrangement						

### Accessories and Others

- It is categorized into AC and DC type with 5 types of contact configurations.
- It has been designed to comply with the IEC 60947 and the protection grade of the product is IP 20
- Permitted range of usable temperature : -25 ~ 40 °C
- It is optimal for control circuit with fast response speed or plant automation.
- Applicable standard and specification :  
IEC 60947-5-1, VDE0660, CENELEC-EN50011

### Accessories

- Front Safety Cover
- Auxiliary Contact Block (Front Mounting)
- Mechanical Latching Block
- Timer

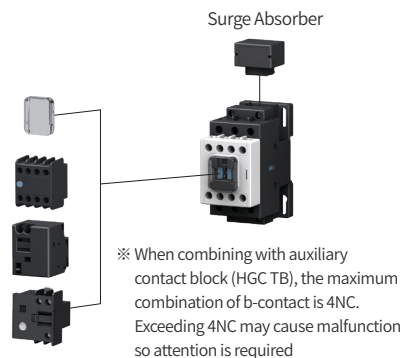

## Ratings and Order Code

### Magnetic Contactor for Capacitor

Product		Rating						Components	
Exterior	Model Name	KVAR (Ambient Temperature of 55 °C, 50/60 Hz)						Magnetic Contactors	
		220 V	230/240 V	400/415 V	440 V	500/550 V	690 V	Model Name	Auxiliary Contact
	HGC9C	5	5	9.7	9.7	14	14	HGC9	2NO + 2NC
	HGC12C	6.7	6.7	12	12	15	15	HGC12	2NO + 2NC
	HGC18C	8.5	8.5	16.7	16.7	24	24	HGC18	2NO + 2NC
	HGC25C	10	10	20	20	26	26	HGC25	2NO + 2NC
	HGC32C	13	13	25	25	30	30	HGC32	2NO + 2NC
	HGC40C	15	15	29	29	35	35	HGC40	2NO + 2NC
	HGC50C	19	19	40	40	45	45	HGC50	2NO + 2NC
	HGC65C	23.5	23.5	43.5	43.5	54	54	HGC65	2NO + 2NC
	HGC75C	28	28	52	52	60	60	HGC75	2NO + 2NC
	HGC85C	32	32	56	56	70	70	HGC85	2NO + 2NC
	HGC100C	35	35	62	62	80	80	HGC100	2NO + 2NC



Components		Order Code		Remark
Capacitor Unit		AC <sup>1)</sup>		
Model Name	Auxiliary Contact	220 V, 60 Hz	220 V, 50 Hz	Composition of Capacitor Switching Contactor
HGC CU40	NONE	HGC9C 22NS A220	HGC9C 22NS X220	
		HGC9C 22NS A220	HGC9C 22NS X220	
HGC CU40		HGC12C 22NS A220	HGC12C 22NS X220	
		HGC12C 22NS A220	HGC12C 22NS X220	
HGC CU40		HGC18C 22NS A220	HGC18C 22NS X220	
		HGC18C 22NS A220	HGC18C 22NS X220	
HGC CU40		HGC25C 22NS A220	HGC25C 22NS X220	
		HGC25C 22NS A220	HGC25C 22NS X220	
HGC CU40		HGC32C 22NS A220	HGC32C 22NS X220	
		HGC32C 22NS A220	HGC32C 22NS X220	
HGC CU40		HGC40C 22NS A220	HGC40C 22NS X220	
		HGC40C 22NS A220	HGC40C 22NS X220	
HGC CU65	HGC50C 22NS A220	HGC50C 22NS X220		
	HGC50C 22NS A220	HGC50C 22NS X220		
HGC CU65	HGC65C 22NS A220	HGC65C 22NS X220		
	HGC65C 22NS A220	HGC65C 22NS X220		
HGC CU100	HGC75C 22NS A220	HGC75C 22NS X220		
	HGC75C 22NS A220	HGC75C 22NS X220		
HGC CU100	HGC85C 22NS A220	HGC85C 22NS X220		
	HGC85C 22NS A220	HGC85C 22NS X220		
HGC CU100	HGC100C 22NS A220	HGC100C 22NS X220		
	HGC100C 22NS A220	HGC100C 22NS X220		

Switching Frequency and Lifespan		
Permitted Switching Frequency		24 million times/h
Electrical Lifespan (AC-6b)	Ue ≤ 440 Vac	100,000 times
	500 Vac ≤ Ue ≤ 690 Vac	100,000 times



  

When Only the Capacitor Unit is Ordered			
Model Name	Aux. Contact	Order Code	Remark
HGC CU40	NONE	HGC CU40 00NS	Quantity of Resistance Cable : 6
HGC CU65		HGC CU65 00NS	
HGC CU100		HGC CU100 00NS	

※ 1) Operational Voltage  
 50 Hz : 24, 48, 110, 120, 220, 240, 380, 440 V  
 60 Hz : 24, 48, 110, 120, 220, 240, 380, 440 V

# Accessories

## Auxiliary Contact Block

Exterior and Name		Rating						
Exterior	Model Name	Rating of Contact						
<p>Front Mounting</p> 	HGCTB	Rated Insulation Current (Ui)	IEC	AC 690 V				
			UL	AC 600 V				
		Rated Thermal Current (Ith)		16 A				
		Rated Operational Current AC15 (Coil Load)	120 V	6 A				
			240 V	4 A				
			380 V	3 A				
			440 V	3 A				
			500 V	2 A				
			690 V	2 A				
		Rated Operational Current DC13 (Coil Load)	24 V	4 A				
			48 V	2.5 A				
			125 V	1.1 A				
			250 V	0.3 A				
			480 V	0.2 A				
			600 V	0.2 A				
<p>Side Mounting</p> 	HGCSB	Based on ZEC60947-4		Based on UL and CSA				
		Rated Insulation Voltage (Ui)		AC 750 V		Thermal Current		
		Rated Thermal Current (Ith)		16 A		16 A		
		Rated Operational Current AC12 (Resistive Load)	110 V	10 A		Rated Operational Current (AC)	120 V	6 A
			220 V	8 A			240 V	3 A
			440 V	6 A			480 V	1.5 A
			690 V	2 A			600 V	1.2 A
			110 V	6 A			125 V	1.1 A
		Rated Operational Current AC15 (Coil Load)	220 V	4 A		Rated Operational Current (DC)	250 V	0.55 A
			440 V	3 A			440 V	0.2 A
			690 V	2 A			600 V	0.2 A
		Rated Operational Current DC12 (Resistive Load)	24 V	4 A		※ Contact Rating Code : A600 - P300		
			48 V	2.5 A				
			125 V	1.1 A				
			250 V	0.3 A				
Rated Operational Current DC13 (Coil Load)	24 V	4 A						
	48 V	2.5 A						
	125 V	1.1 A						
	250 V	0.3 A						

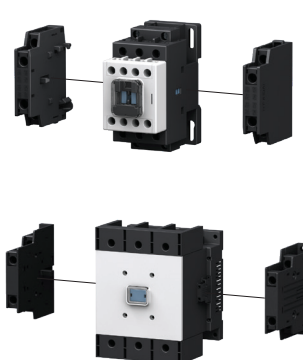
Contact Arrangement		Order Code	Others				
Combination	Arrangement	With Terminal Cover	Weight	Applicable Magnetic Contactor	Installation Method		
2NC	<pre> 51 61      b  b      52 62                     </pre>	HGC TB02NS	0.031	HGC9 ~ 100 HGR	<p>Front Mounting</p>  <p>※ Maximum number of b contacts that can be combined is 4NC.</p>		
1NO + 1NC	<pre> 53 61      o  b      54 62                     </pre>	HGC TB11NS					
2NO	<pre> 53 63      o  o      54 64                     </pre>	HGC TB20NS					
4NC	<pre> 51 61 71 81            b  b  b  b            52 62 72 82                     </pre>	HGC TB04NS					
1NO + 3NC	<pre> 51 63 71 81            b  o  b  b            52 64 72 82                     </pre>	HGC TB13NS	0.053				
2NO + 2NC	<pre> 53 61 71 83            o  b  b  o            54 62 72 84                     </pre>	HGC TB22NS					
3NO + 1NC	<pre> 53 61 73 83            o  b  o  o            54 62 74 84                     </pre>	HGC TB31NS					
4NO	<pre> 53 63 73 83            o  o  o  o            54 64 74 84                     </pre>	HGC TB40NS					
1NO + 1NC	<pre> 53/84 61/72      o  b      54/83 62/71                     </pre>	HGC SB40 11NS	0.028			HGC9 ~ 40	<p>Side Installation</p>  <p>※ Maximum number of b contacts that can be combined is 4NC.</p>
		HGC SB100 11NS	0.053			HGC50 ~ 100	
		HGC SB800 11NS	0.042	HGC115 ~ 800			

## Accessories

### Interlock Unit

The interlock unit is an accessory that provides interlock function for reversion operation of the magnetic contactors. Also, the mechanical interlock function can be configured. The reverse operation type of magnetic contactors configured with mechanical interlocks is not closed simultaneously so it is more reliable than the electrical interlocks.

#### Selection and Order

Order Code	Applicable Magnetic Contactor	Weight (kg)
HGC IU40	HGC9 ~ 40	0.03
HGC IU100	HGC50 ~ 100	0.03
HGC IU265	HGC115 ~ 265	0.081
HGC IU800	HGC300 ~ 800	0.101

### Wire kit

Set of cable for connecting the main circuit of the reverse operation type of magnetic contactor.

#### Selection and Order

Order Code	Applicable Magnetic Contactor	Weight (kg)
HGC RB18	HGC9 ~ 18	0.2
HGC RB40	HGC25 ~ 32	0.2
HGC RB65	HGC40 ~ 65	0.3
HGC RB100	HGC75 ~ 100	0.5

### Handling

- Electrical interlock must be used together by using the NC contact of the magnetic contactor.
- When mounting the product, do not install vertically.
- In case of HGC115 ~ 800, the auxiliary contact block installed between the reverse operation type of magnetic contactor must be removed before installation.
- Do not apply excessive force when checking the simultaneously input by moving it left and right manually. It may cause damage.
- It is not applicable to DC type of HGC40 ~ 100.

#### HGC9 ~ 100

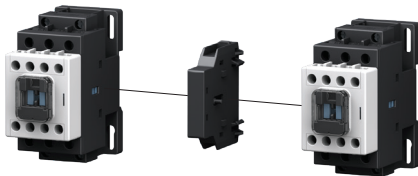

#### HGC115 ~ 800

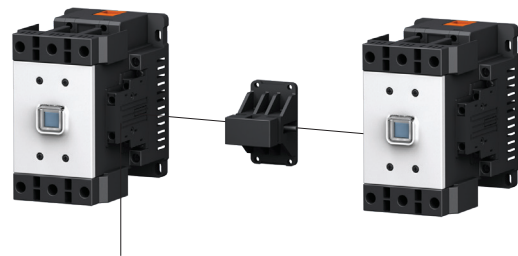

Install after removing the auxiliary contact block installed between the magnetic contactor.



Interlock Unit

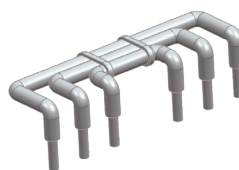

Wire Kit



## Mechanical Latching Block

The mechanical latching block maintains the mechanical closed state even if the excitation state of the coil has become loose due to a drop in operational voltage below the rated voltage that is supplied to the coil of the magnetic contactor and the control relay. The mechanical latching block manufactured in a module method can be installed using a One-Touch method at the magnetic contactor and the control relay.

### Ratings and Characteristics

Coil Power Consumption	VA	25
	W	20
Voltage	V	$(0.85 \sim 1.1) \times U_c$
Operation Frequency	Cycle/h	1,200
Operational Voltage	AC	24, 48, 100 ~ 125, 200 ~ 240 V 440 V
	DC	24, 48, 100 ~ 125, 200 ~ 240 V
Mechanical Lifespan	10,000 times	50
Weight	kg	0.1

### Selection and Order

Model Name	Order Code	Current	Operational Voltage	Applicable Magnetic Contactor
HGC LB100	HGC LB100 F024	AC/DC	24 V	HGC9 ~ 100 HGR
	HGC LB100 F048		48 V	
	HGC LB100 F110		100 ~ 125 V	
	HGC LB100 F220		200 ~ 240 V	
	HGC LB100 A440	AC	440 V	

### Circuit Diagram

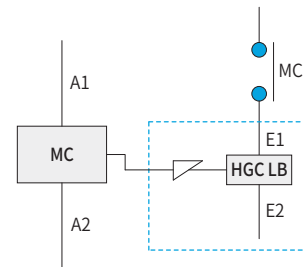

※ A1/A2 : Coil terminal, E1/E2 : Latching block terminal

### Handling

- The latching block functions after receiving the mechanical closing signal from the magnetic contactor or the control relay and the closing state of the main contact is maintained even if the excitation state of the magnetic contactor or the control relay's coil has become loose due to momentary black-out of the cable.
- How to turn the magnetic contactor or the control relay off
  - Manual : Set the button on the latching block to "O" position.
  - Electrical : Apply de-energized voltage to the coil in the latching block. The power of the magnetic contactor (Control relay) assembled must be Off before supplying power to the coil of the latching block.
- How to open the magnetic contactor or the control relay
  - If the button located at the "I" part of the latching block is pressed, it can be opened without exciting the coil of the magnetic contactor or the control relay.
- Caution
  - Do not excite the magnetic contactor or the control relay with the latching block simultaneously.
  - The latching block functions instantaneously so do not apply power of more than 1 sec at the power part (E1, E2).
  - As for the circuit diagram of the latching block, please refer to the diagram on the right.



## Accessories

### Surge Absorber

#### Surge Absorber (RC-Unit)

- The surge voltage occurs during the operation of the magnetic contactor or the control relay and the surge voltage is normally 10 ~ 20 times higher than the rated voltage so the surge absorber drops the surge voltage to approximately 3 times less.
- It is optimal for the switching circuit that uses PLC.
- It prevents damage in the electronic parts caused by high surge voltage.
- It is applicable to both 50/60 Hz. (In case of RC-Unit)
- If noise components exceeding 400Hz or more than 5% noise, internal device degradation may occur.

#### Selection and Order

Product	Order Code	Operational Voltage	Magnetic Contactor	Weight (kg)
RC-Unit	HGC RC40 Y048	AC 24 ~ 48 V	HGC9 ~ 40, HGR	0.029
	HGC RC40 Y220	AC 110 ~ 220 V		
	HGC RC40 Y380	AC 240 ~ 380 V		
	HGC RC100 Y048	AC 24 ~ 48 V	HGC50 ~ 100, HGC50B ~ 100B	
	HGC RC100 Y220	AC 110 ~ 220 V		
	HGC RC100 Y380	AC 240 ~ 380 V		
	HGC RC800 Y220	AC 110~220V		

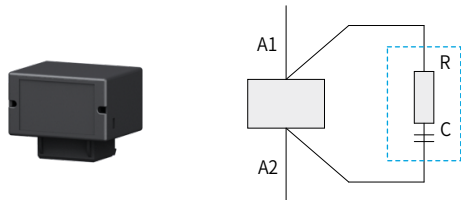

#### Surge Absorber (Varistor + RC-Unit)

- HGC RC100 F110/F220 products are available for AC/DC using varistors.
- When surge voltage comes in, it discharges the voltage through the varistor to prevent sudden high voltage from entering.

#### Selection and Order

Product	Order Code	Operational Voltage	Magnetic Contactor	Weight (kg)
RC-Unit with Varistor	HGC RC100 F110	AC 48 ~ 110 V	HGC9 ~ 100, HGR	0.029
		DC 48 ~ 110 V		
	HGC RC100 F220	AC 110 ~ 220 V		
		DC 110 ~ 220 V		

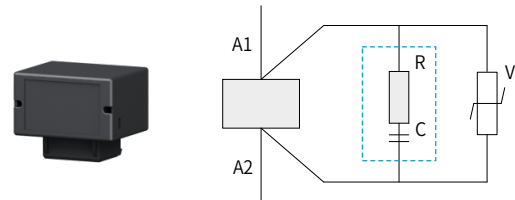

#### Clamping Diode

- It is used for the purpose of preventing counter electromotive force on the DC power supply.
- It must be installed when the coil is connected in parallel.
- It prevents damage in the electronic parts by preventing counter electromotive power.

#### Selection and Order

Product	Order Code	Operational Voltage	Magnetic Contactor	Weight (kg)
Clamping Diode	HGC CD100	DC 24 ~ 220 V	HGC9 ~ 100, HGR	0.029

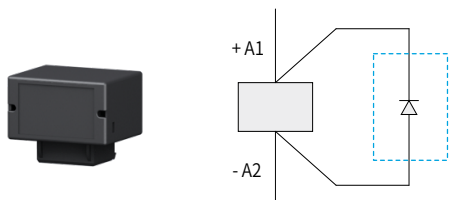

## Electronic Timer Block

- As it has been manufactured in a module method, it enables One-Touch mounting on the electronic contactor and control relay, saving space.
- It has been designed for AC/DC with comprehensive operational voltage.
- On-Delay and Interval timer functions can be realized using one timer and it is optimal as a Y-Δ starter.

### Selection and Order

Order Code	Magnetic Contactor	Operational Voltage
HGC ET1	HGC9 ~ 100, HGR	AC/DC 90 ~ 240 V
HGC ET2		AC/DC 24 ~ 60 V

### Ratings and Selection

Model Name	Order Code	HGC ET1	HGC ET2
Rated Voltage	AC/DC V	90 ~ 240	24 ~ 60
Permitted Voltage	V	(0.8 ~ 1.1) × Rated Voltage	
Breaking Capacity	VA	90	
Maximum Load	VA	15	
Delay Time	Position A	10 ~ 220	
	Position B	0.15 ~ 15	
Precision	%	±5	
Repetition Margin of Error	%	0.1	
	secs	50 ms	
Weight	kg	0.053	

### Operation Concept Map

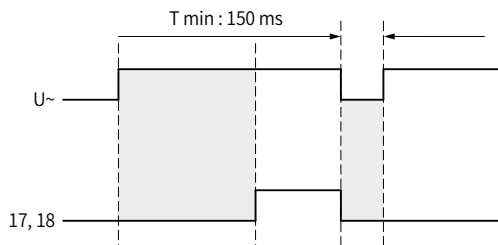

• Position 1 : On-Delay / t : Control time 0.15....220 sec

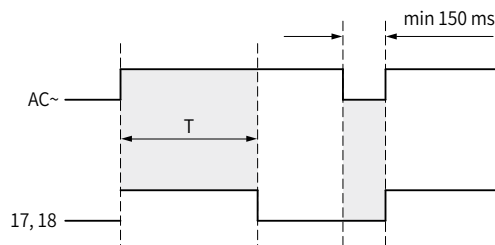

• Position 2 : Interval Timer

※ After the power has been turned off, resting time of 150 ms is required for re-operation.

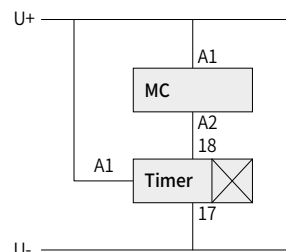

※ A1/A2 : Coil terminal, 17/18 : Timer terminal

# Accessories

## Control Coil





Product	Operational Voltage		Order Code				
	Frequency	V	Applicable Magnetic Contactor				
			HGC9 ~ 18	HGC25 ~ 40	HGC50 ~ 65	HGC75 ~ 100	
	AC 60 Hz	24	HGCOLPKG18 A24	HGCOLPKG40 A24	HGCOLPKG65 A24	HGCOLPKG100 A24	
		48	HGCOLPKG18 A48	HGCOLPKG40 A48	HGCOLPKG65 A48	HGCOLPKG100 A48	
		110	HGCOLPKG18 A110	HGCOLPKG40 A110	HGCOLPKG65 A110	HGCOLPKG100 A110	
		120	HGCOLPKG18 A120	HGCOLPKG40 A120	HGCOLPKG65 A120	HGCOLPKG100 A120	
		220	HGCOLPKG18 A220	HGCOLPKG40 A220	HGCOLPKG65 A220	HGCOLPKG100 A220	
		240	HGCOLPKG18 A240	HGCOLPKG40 A240	HGCOLPKG65 A240	HGCOLPKG100 A240	
		380	HGCOLPKG18 A380	HGCOLPKG40 A380	HGCOLPKG65 A380	HGCOLPKG100 A380	
		440	HGCOLPKG18 A440	HGCOLPKG40 A440	HGCOLPKG65 A440	HGCOLPKG100 A440	
	AC 50 Hz	24	HGCOLPKG18 X24	HGCOLPKG40 X24	HGCOLPKG65 X24	HGCOLPKG100 X24	
		48	HGCOLPKG18 X48	HGCOLPKG40 X48	HGCOLPKG65 X48	HGCOLPKG100 X48	
		110	HGCOLPKG18 X110	HGCOLPKG40 X110	HGCOLPKG65 X110	HGCOLPKG100 X110	
		120	HGCOLPKG18 X120	HGCOLPKG40 X120	HGCOLPKG65 X120	HGCOLPKG100 X120	
		220	HGCOLPKG18 X220	HGCOLPKG40 X220	HGCOLPKG65 X220	HGCOLPKG100 X220	
		240	HGCOLPKG18 X240	HGCOLPKG40 X240	HGCOLPKG65 X240	HGCOLPKG100 X240	
		380	HGCOLPKG18 X380	HGCOLPKG40 X380	HGCOLPKG65 X380	HGCOLPKG100 X380	
		440	HGCOLPKG18 X440	HGCOLPKG40 X440	HGCOLPKG65 X440	HGCOLPKG100 X440	
	DC	24	HGCOLPKG18 D24	HGCOLPKG40 D24	HGCOLPKG65 D24	HGCOLPKG100 D24	
		48	HGCOLPKG18 D48	HGCOLPKG40 D48	HGCOLPKG65 D48	HGCOLPKG100 D48	
		110	HGCOLPKG18 D110	HGCOLPKG40 D110	HGCOLPKG65 D110	HGCOLPKG100 D110	
		125	HGCOLPKG18 D125	HGCOLPKG40 D125	HGCOLPKG65 D125	HGCOLPKG100 D125	
		220	HGCOLPKG18 D220	HGCOLPKG40 D220	HGCOLPKG65 D220	HGCOLPKG100 D220	
		Nominal Voltage	V	Applicable Magnetic Contactor			
				HGC115 ~ 150	HGC185 ~ 265	HGC300 ~ 500	HGC630 ~ 800
		24	AC 24 ~ 26 DC 24	HGCOL150 F24	HGCOL265 F24	-	-
		48	AC 44 ~ 52 DC 48	HGCOL150 F48	HGCOL265 F48	HGCOL500 F48	-
110		AC 100 ~ 127 DC 100 ~ 110	-	-	-	HGCOL800 F110	
220		AC 100 ~ 127 DC 100 ~ 110	HGCOL150 F220	HGCOL265 F220	HGCOL500 F220	-	
220		AC 200 ~ 240 DC 200 ~ 220	-	-	-	HGCOL800 F220	
440	AC 380 ~ 450	HGCOL150 F440	HGCOL265 F440	HGCOL500 F440	HGCOL800 F440		

※ When ordering HGC115 ~ 800, it is provided in Ass'y including the AD converter is provided

※ Relay coils are marked as HGRCOL A220, D110 and others and P type is not sold separately.



## Contacts and Covers

Product	Model Name	Applicable Product	Order Code	Components	
<b>Main Contact</b>		Magnetic contactor for use		1 SET	1 Order standard(set)
 <p>Moving Contact</p>  <p>Fixed Contact</p>	HGCTIP	HGC9	HGCTIP9	Moving Contact : 3 EA Fixed contact : 6 EA	1
		HGC12	HGCTIP12		
		HGC18	HGCTIP18		
		HGC25	HGCTIP25		
		HGC32	HGCTIP32		
		HGC40	HGCTIP40		
		HGC50	HGCTIP50		
		HGC65	HGCTIP65		
		HGC75	HGCTIP75		
		HGC85	HGCTIP85		
		HGC100	HGCTIP100		
		HGC115	HGCTIP115		
		HGC130	HGCTIP130		
		HGC150	HGCTIP150		
		HGC185	HGCTIP185		
		HGC225	HGCTIP225		
		HGC265	HGCTIP265		
		HGC300	HGCTIP300		
		HGC400	HGCTIP400		
		HGC500	HGCTIP500		
HGC630	HGCTIP630				
HGC800	HGCTIP800				
<b>Protection Cover</b>		Magnetic contactor for use		1 SET	1 Order standard(set)
 <p>Main Terminal Cover</p>  <p>Coil Terminal Cover</p>	HGPCP	HGC9 ~ 18	HGCPC1811NS HGPCP1822NS	Main Terminal Cover : 2 EA Coil Terminal Cover : 2 EA Auxiliary Terminal Cover : 2 EA	5
		HGC25 ~ 40	HGCPC4011NS HGPCP4022NS		
		HGC50 ~ 65	HGCPC65		
		HGC75 ~ 100	HGCPC100		2
		HGC115 ~ 150	HGCPC150		3
		HGC185 ~ 265	HGCPC265	Main Terminal Cover : 2 EA Coil Terminal Cover : 2 EA Auxiliary Terminal Cover : 8 EA	2
		HGC300 ~ 500	HGCPC500		2
		HGC630 ~ 800	HGCPC800		5
		HGR	HGRPC	Main Terminal Cover : 2 EA Coil Terminal Cover : 2 EA	5
		<b>Front Cover</b>		Magnetic contactor for use	
	HGFCF	HGC9 ~ 100	HGFCF100	Front Cover : 1 EA	4
		HGC115 ~ 150	HGFCF150		
		HGC185 ~ 265	HGFCF265		
		HGC300 ~ 500	HGFCF400		
		HGC630 ~ 800	HGFCF800		

※ The order code of HGC18 and 40 varies depending on the number of auxiliary contacts, so please pay attention to the order.

## Accessories

### Order Code

HGC	TB		22NS	N	
Model Name	Accessories		Detailed Ratings	Purpose	
HGC	<b>TB</b>	Auxiliary Contact (Front Mounting)	Refer to the Relevant Page per Accessory	<b>N</b>	Non 1E Class
	<b>SB</b>	Auxiliary Contact (Side Mounting)			
	<b>IU</b>	Interlock Unit	Nuclear		
	<b>LB</b>	Mechanical Latching Block	<b>04Q</b>	0NO + 4NC	
	<b>RC</b>	Surge Absorber	<b>13Q</b>	1NO + 3NC	
	<b>CD</b>	Clamping Diode	<b>22Q</b>	2NO + 2NC	
	<b>ET</b>	Electronic Timer	<b>31Q</b>	3NO + 1NC	
	<b>CU</b>	Capacitor Switching Unit	<b>40Q</b>	4NO + 0NC	

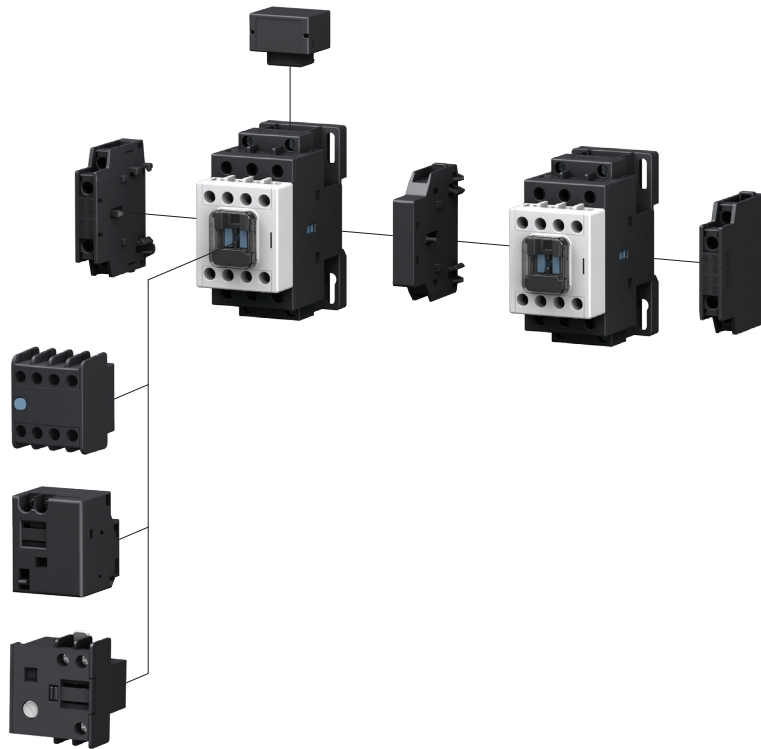

※ The order format above is to explain the order code. For detailed specification per type, refer to the relevant page upon placing the order.

# Dimensions

## Magnetic Contactor

Unit : mm

HGC9  
HGC12  
HGC18

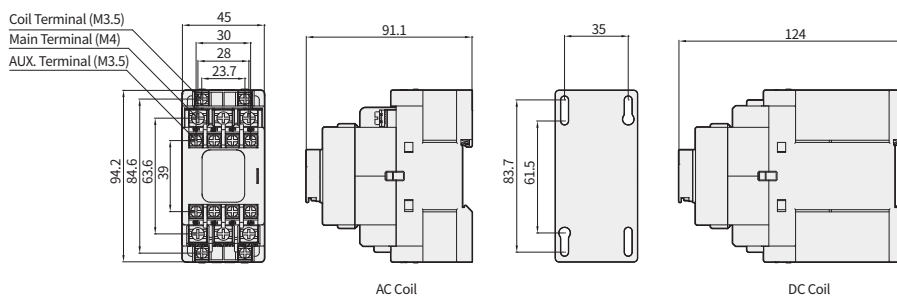

Accessories	A (mm)
Auxiliary Contact HGCTB	35
Latching Block HGCLB	42.5
Timer HG CET	39

HGC25  
HGC32  
HGC40

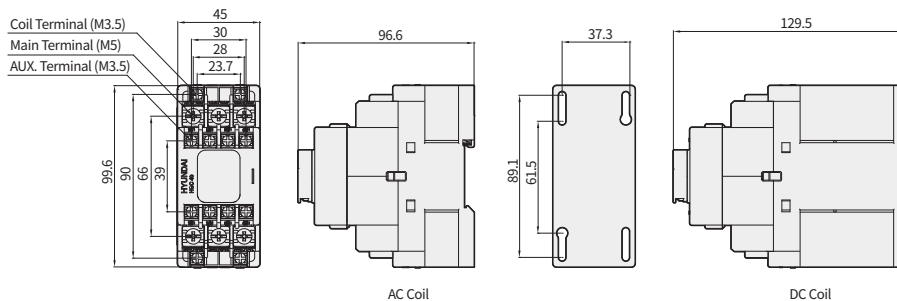

Accessories	A (mm)
Auxiliary Contact HGCTB	35
Latching Block HGCLB	42.5
Timer HG CET	39

HGC50  
HGC65  
(AC/DC)

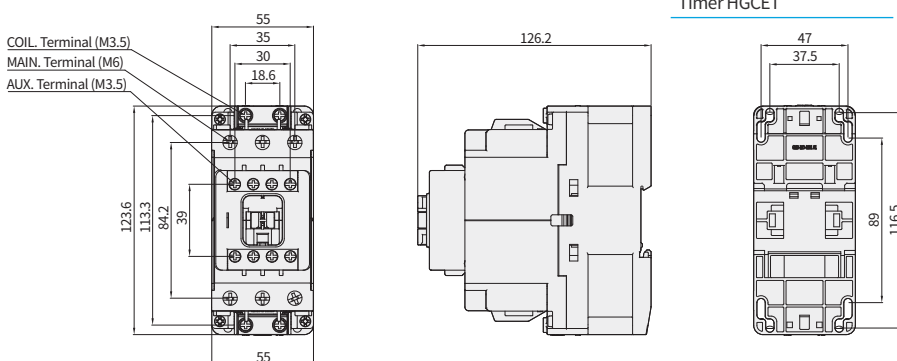

Accessories	A (mm)
Auxiliary Contact HGCTB	35
Latching Block HGCLB	42.5
Timer HG CET	39

※ The dimensions of the drawing on this page may be subject to change without notice.

( ) Refers to the DC type.

# Dimensions

## Electronic Contactor

Unit : mm

HGC75  
HGC85  
HGC100  
(AC/DC)

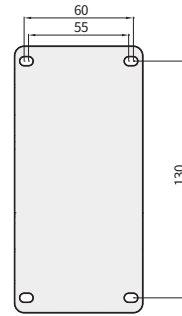
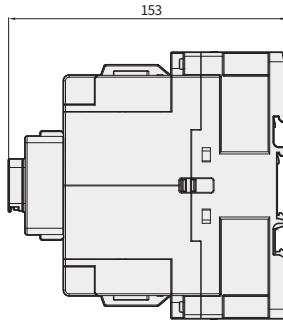
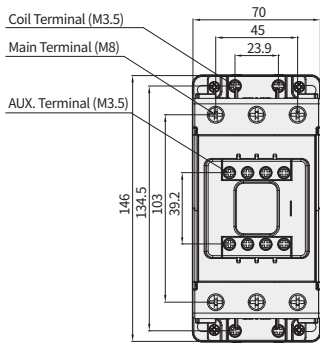

Accessories	A (mm)
Auxiliary Contact HGCTB	35
Latching Block HGCLB	42.5
Timer HG CET	39

HGC115  
HGC130  
HGC150

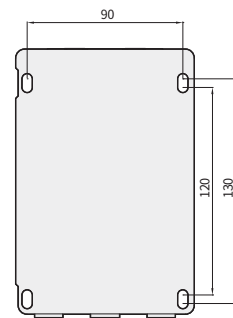
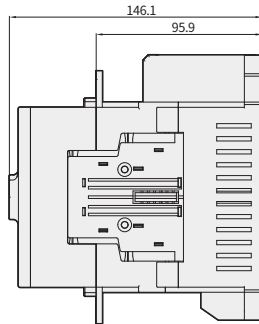
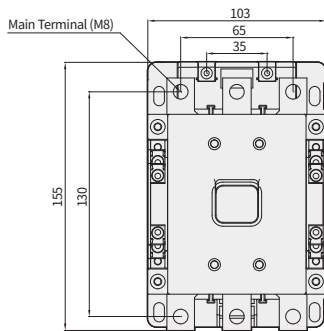

HGC185  
HGC225  
HGC265

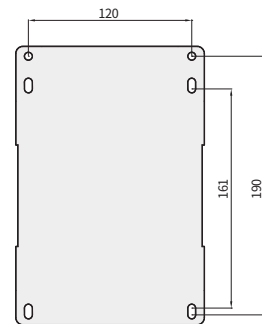
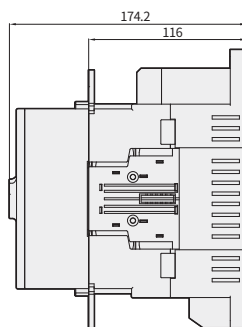
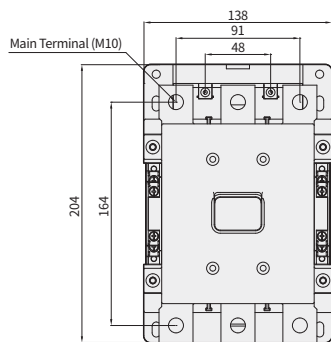

※ The dimensions of the drawing on this page may be subject to change without notice.  
( ) Refers to the DC type.

Unit : mm

HGC300  
HGC400  
HGC500

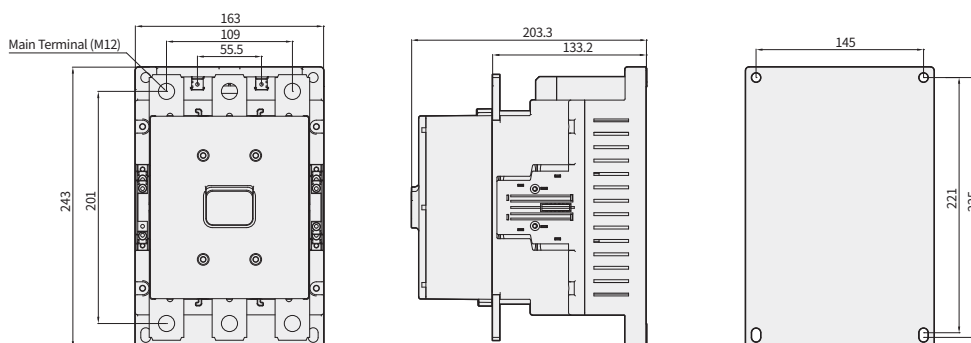

HGC630  
HGC800

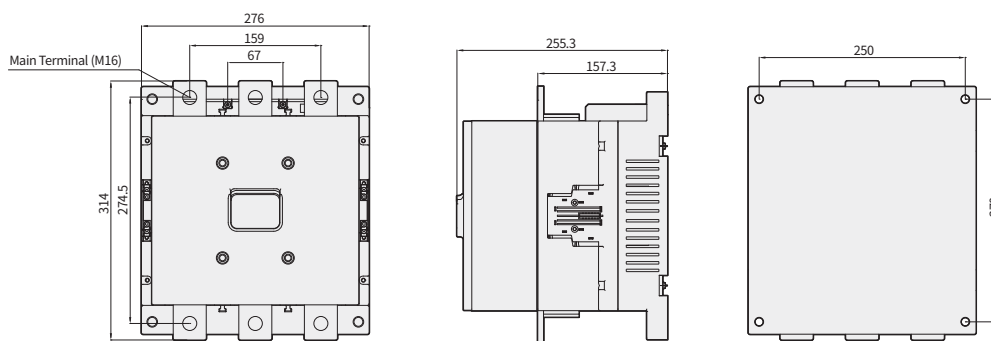

※ The dimensions of the drawing on this page may be subject to change without notice.  
( ) Refers to the DC type.

# Dimensions

## Control Relay

Unit : mm

### HGR (AC)

Accessories	A (mm)
Auxiliary Contact HGCTB	35
Latching Block HGCLB	42.5
Timer HGCT	39

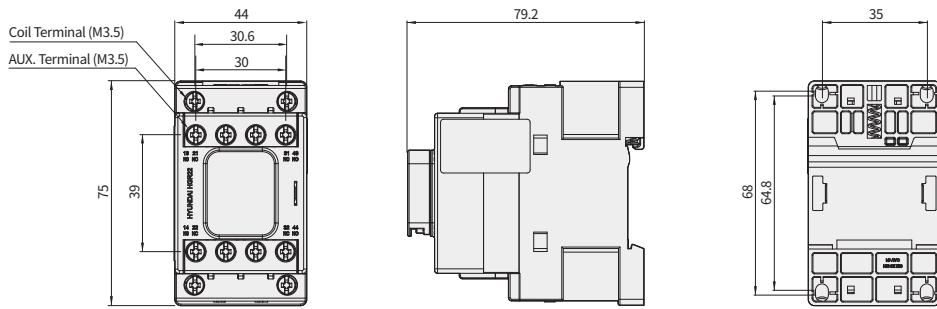

### HGR-P (Magnetic Type) (DC)

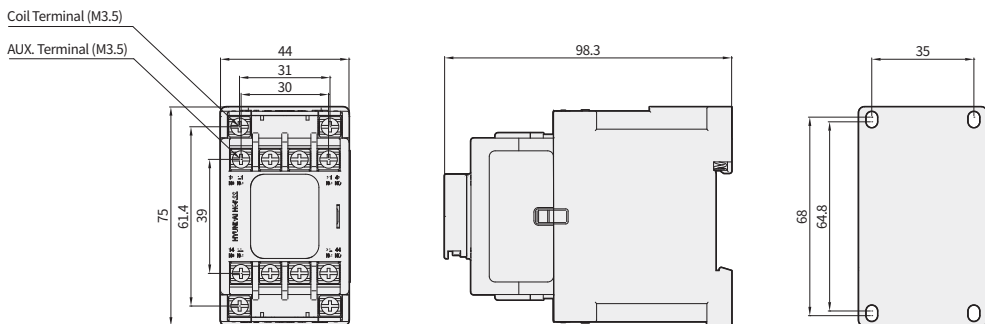

※ The dimensions of the drawing on this page may be subject to change without notice.  
 ( ) Refers to the DC type.

### Auxiliary Contact Block (Front Mounting)

Unit : mm

HGCTB4P

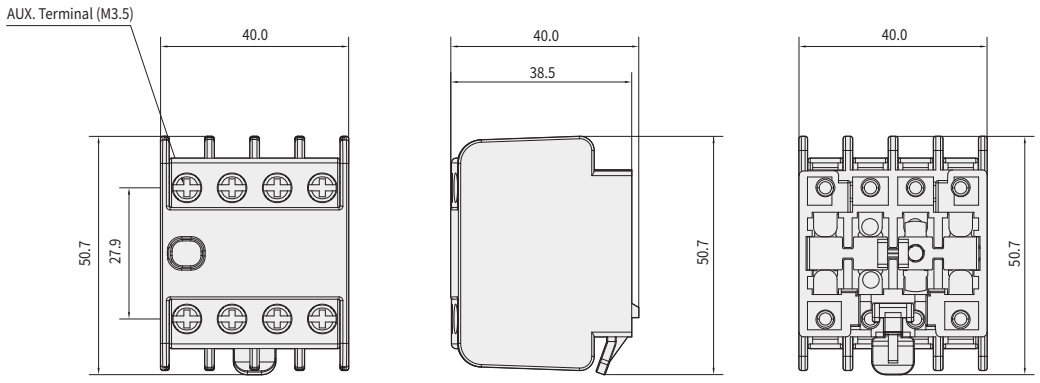

HGCTB2P

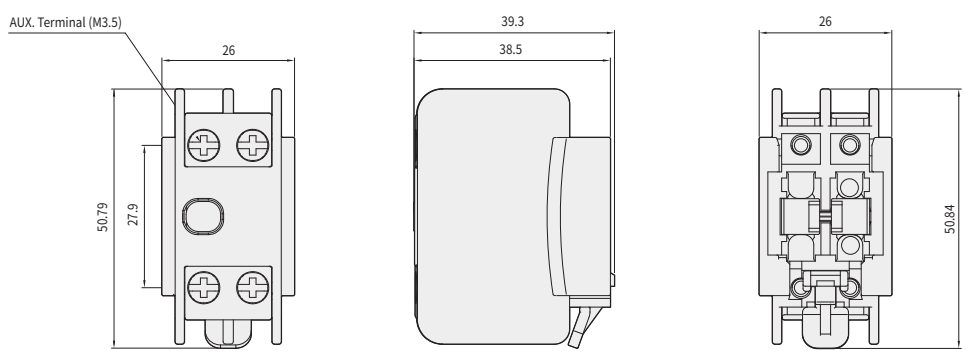

※ The dimensions of the drawing on this page may be subject to change without notice.

VCB

ACB

MCCB

MS

RELAY

## Dimensions

### Auxiliary Control Block (Side Mounting)

Unit : mm

HGCSB40

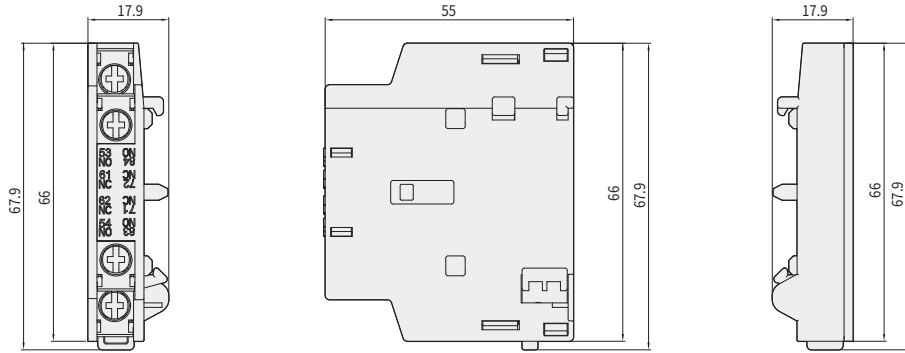

HGCSB100

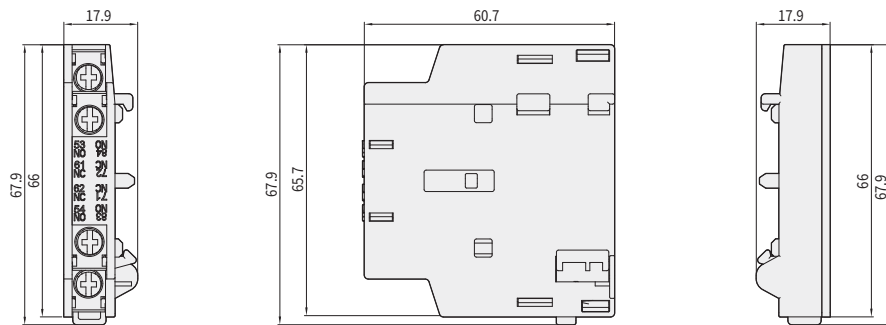

HGCSB800

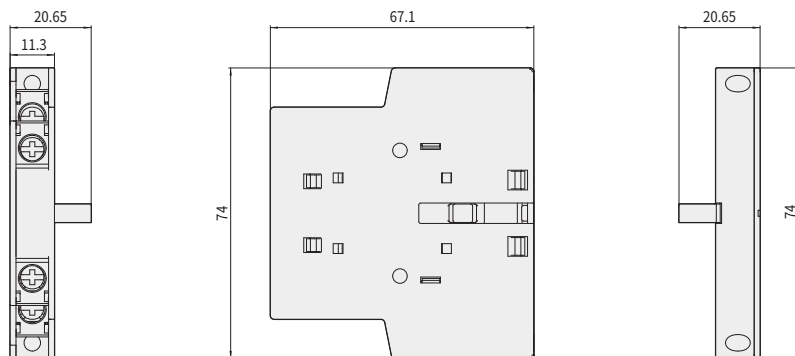

※ The dimensions of the drawing on this page may be subject to change without notice.



### Interlock Unit

Unit : mm

HGCIU40

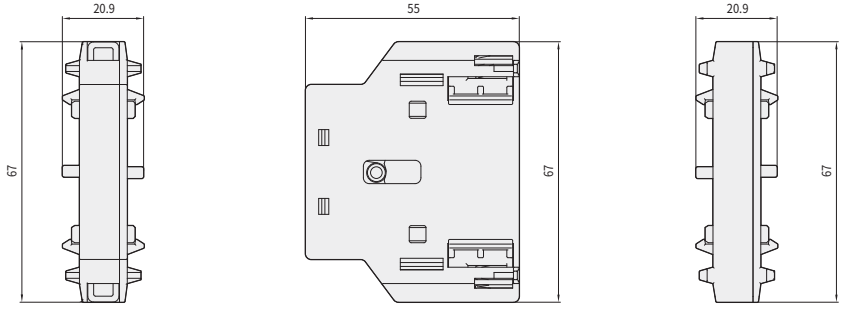

HGCIU100

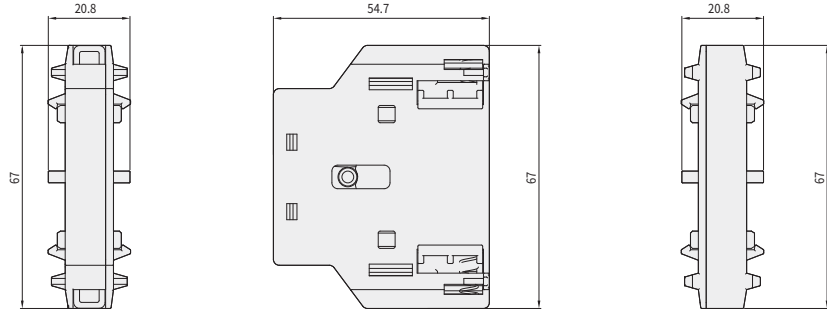

HGCIU265

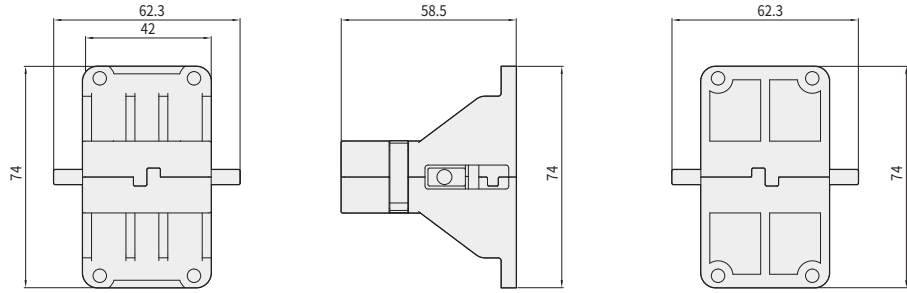

HGCIU800

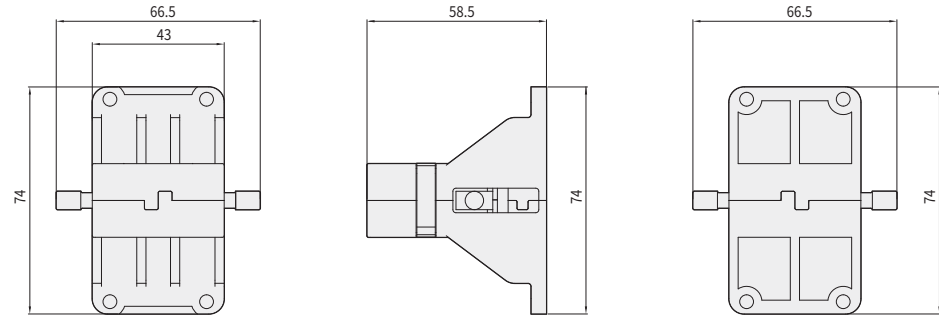

※ The dimensions of the drawing on this page may be subject to change without notice.

VCB

ACB

MCCB

MS

RELAY

# Dimensions

## Magnetic Contactor + Thermal Overload Relay

Unit : mm

<p>HGC9 HGC12 HGC18 + HGT18</p>			
<p>HGC25 HGC32 HGC40 + HGT40</p>			
<p>HGC50 HGC65 + HGT65</p>			
<p>HGC75 HGC85 HGC100 + HGT100</p>			

※ The dimensions of the drawing on this page may be subject to change without notice.

Unit : mm

HGC115  
HGC130  
HGC150 +  
HGT150

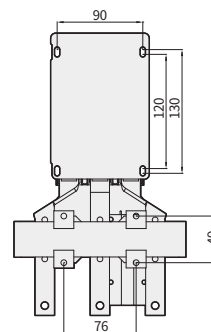
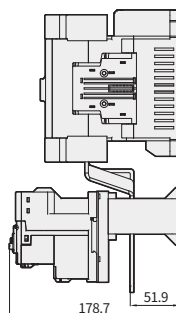
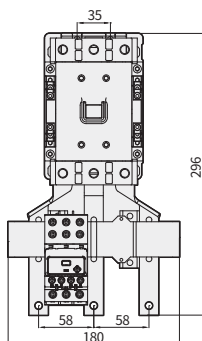

HGC185  
HGC225  
HGC265 +  
HGT265

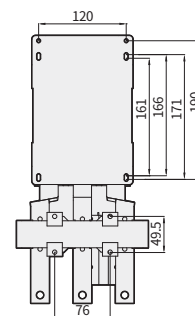
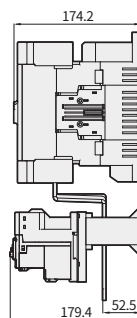
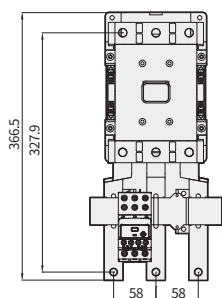

HGC300  
HGC400  
HGC500 +  
HGT500

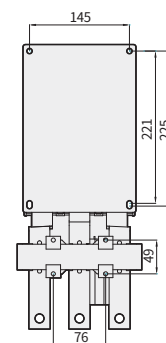
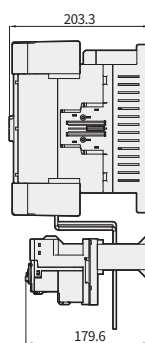
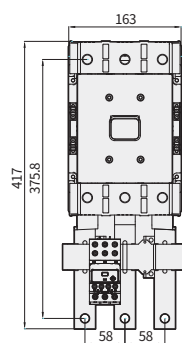

HGC630  
HGC800 +  
HGT800  
(630, 800A)

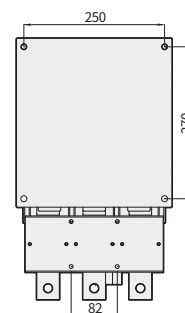
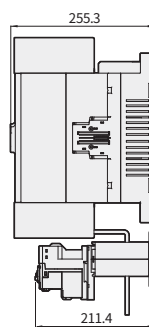
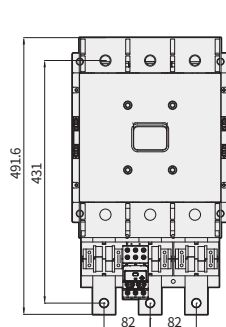

※ The dimensions of the drawing on this page may be subject to change without notice.

# Dimensions

## Thermal Overload Relay

Unit : mm

### HGT18

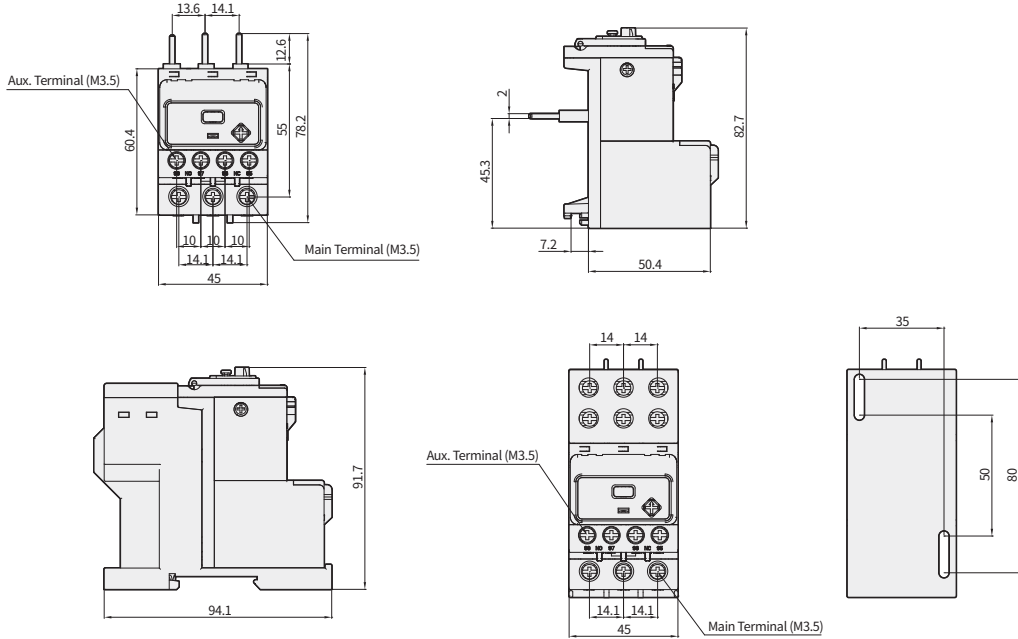

### HGT40

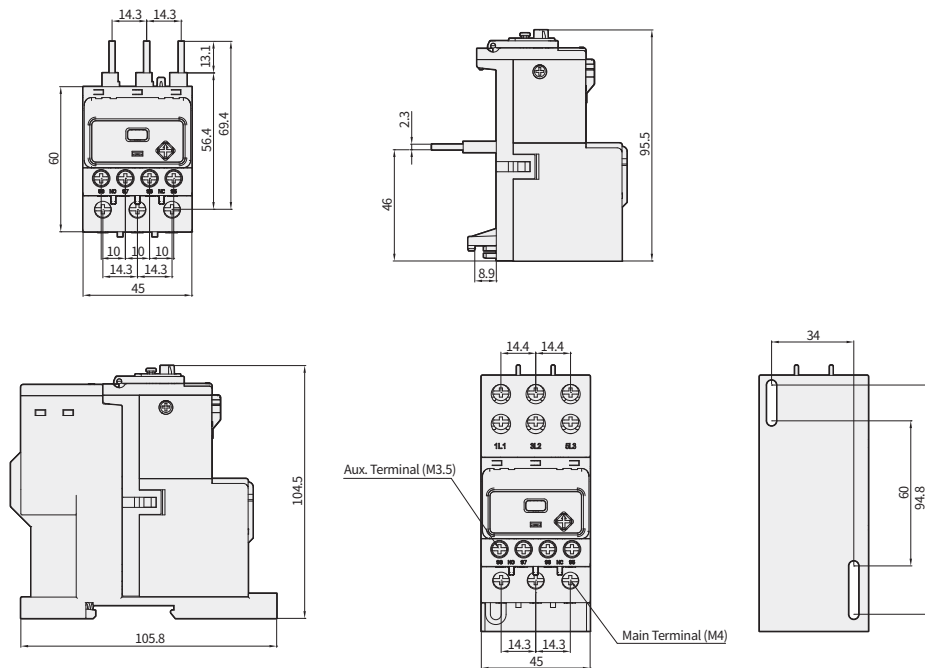

※ The dimensions of the drawing on this page may be subject to change without notice.

Unit : mm

HGT65

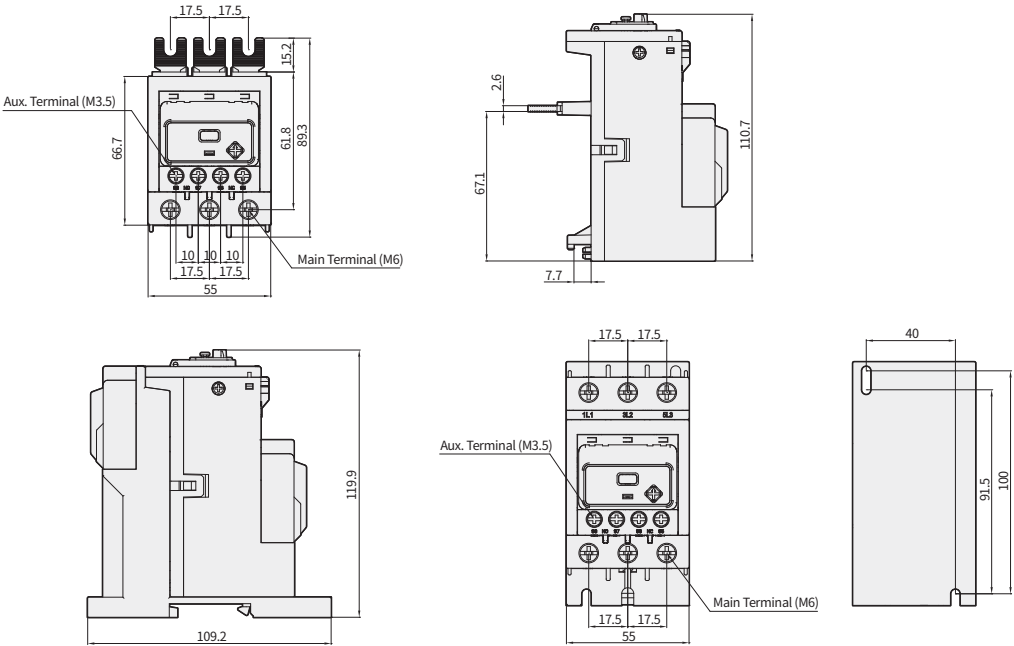

HGT100

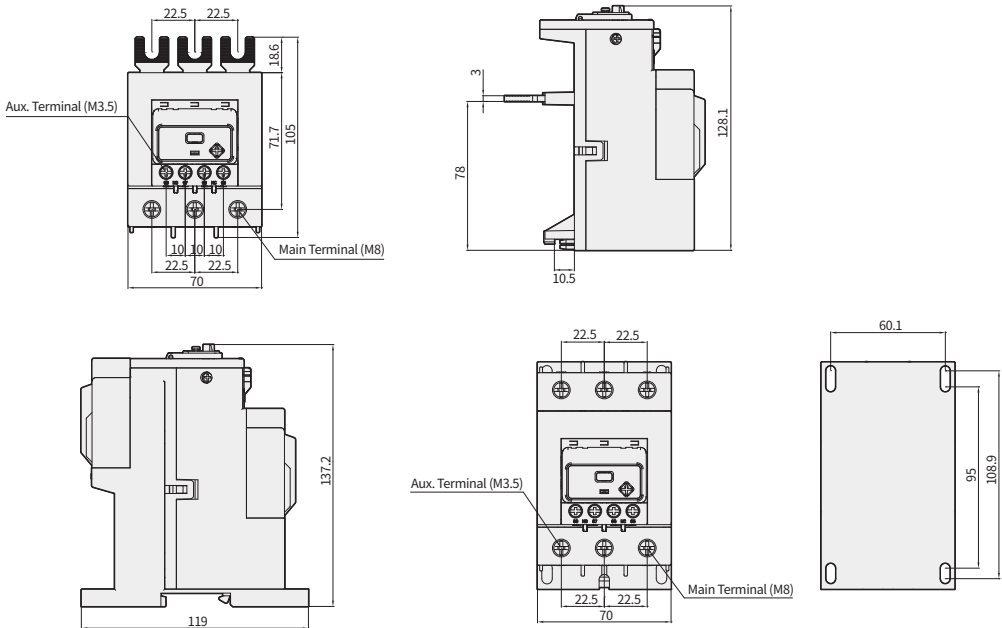

※ The dimensions of the drawing on this page may be subject to change without notice.

VCB

ACB

MCCB

MS

RELAY

# Dimensions

## Thermal Overload Relay

Unit : mm

### HGT150

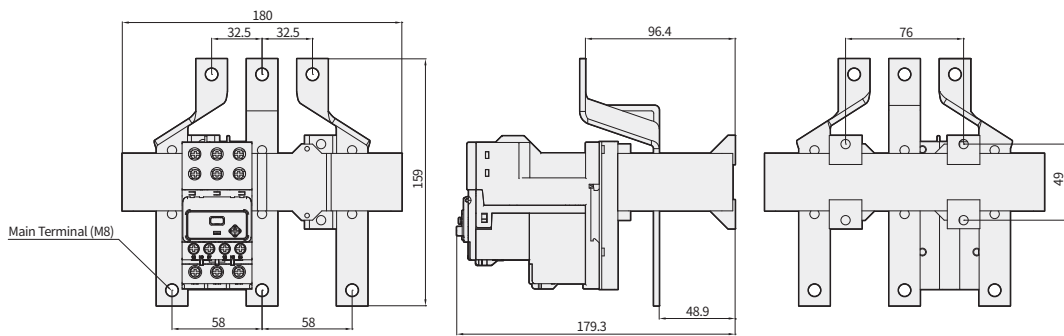

### HGT265

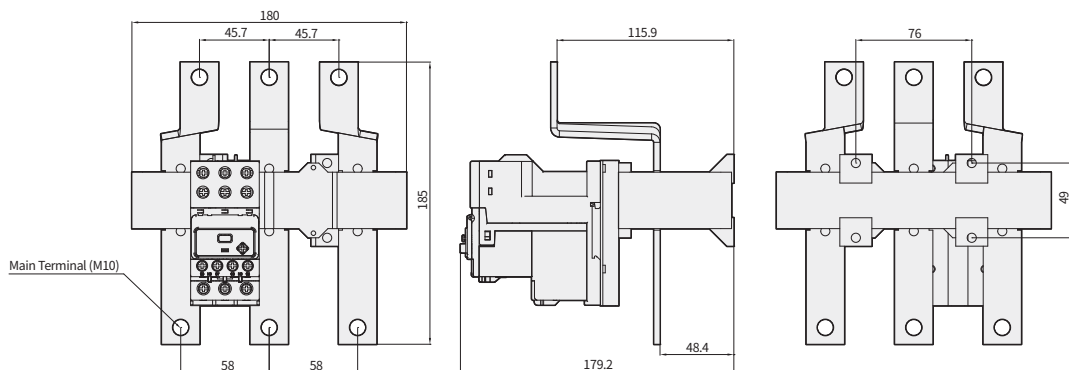

※ The dimensions of the drawing on this page may be subject to change without notice.

Unit : mm

HGT500

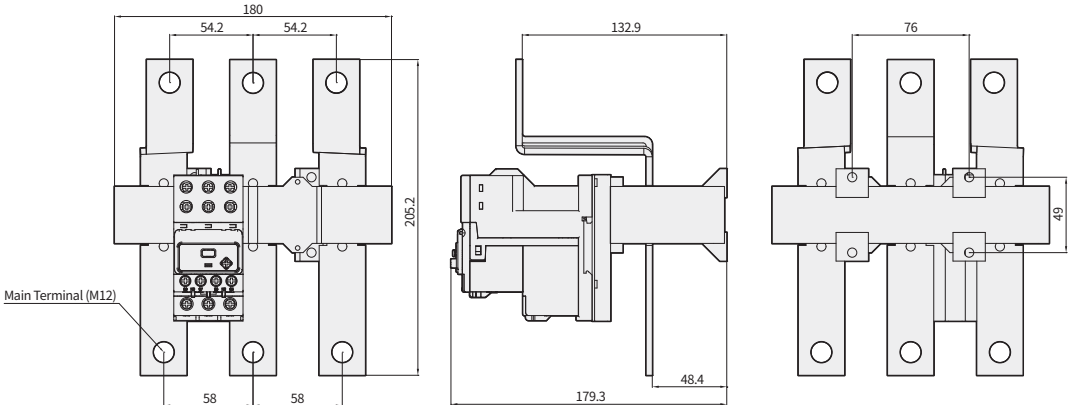

HGT800

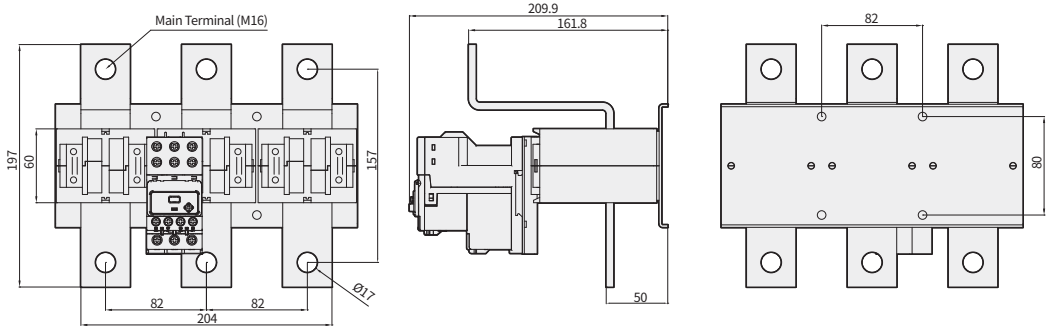

※ The dimensions of the drawing on this page may be subject to change without notice.

## Dimensions

### Magnetic Contactor + Capacitor Switching Unit

Unit : mm

#### HGC18C

When connecting the resistance cable, 1.5 times the 94.2 space is required

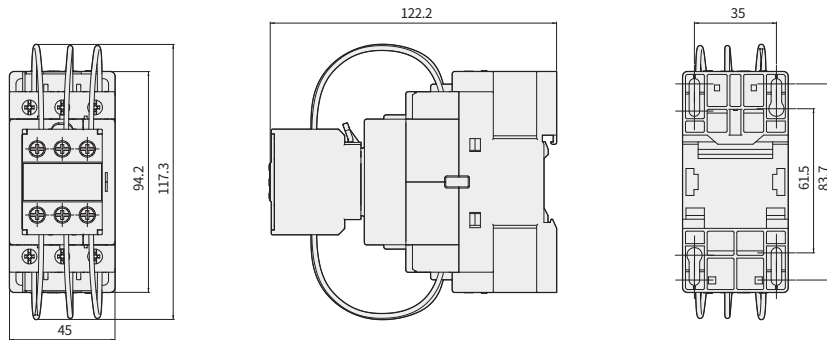

#### HGC40C

When connecting the resistance cable, 1.5 times the 99.6 space is required

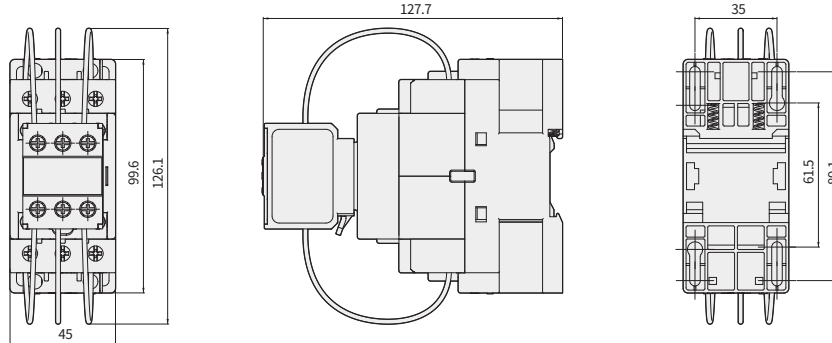

#### HGC65C

When connecting the resistance cable, 1.5 times the 123.6 space is required

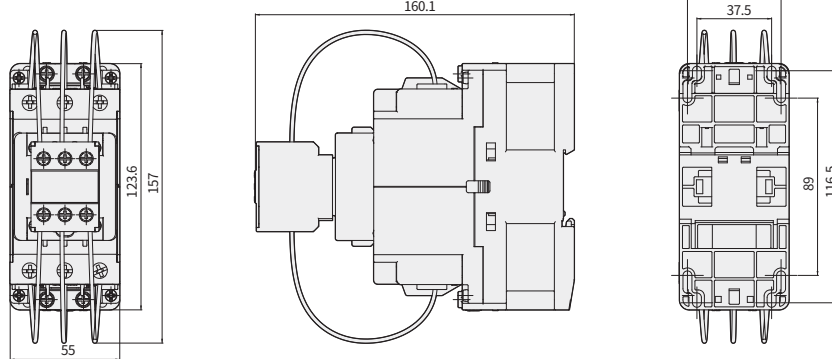

#### HGC100C

When connecting the resistance cable, 1.5 times the 146 space is required

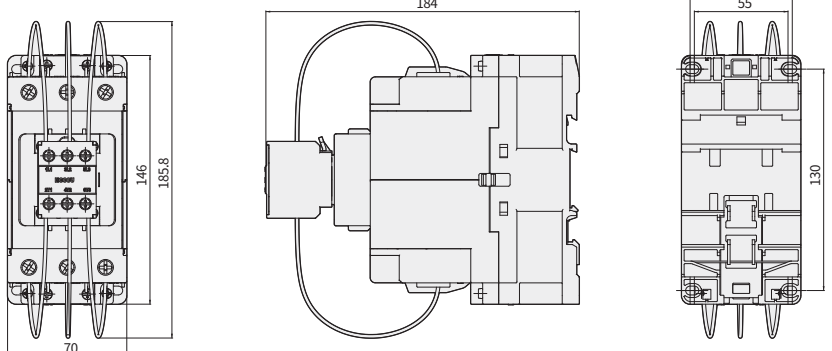

※ The dimensions of the drawing on this page may be subject to change without notice.



## Reverse Operation Magnetic Contactor (With Interlock Unit)

Unit : mm

HGC18R

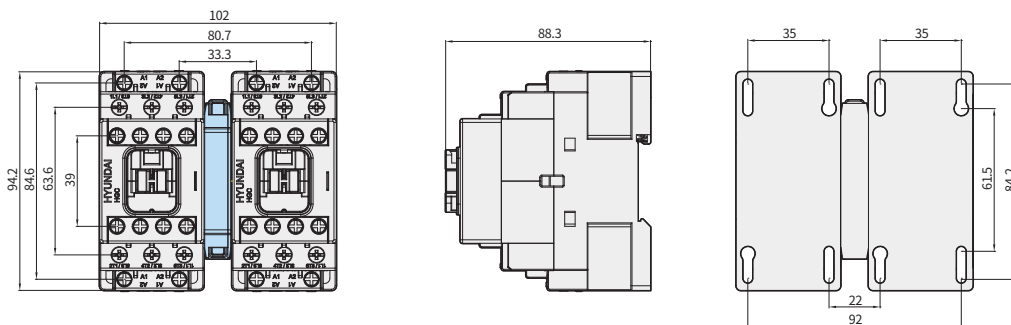

HGC40R

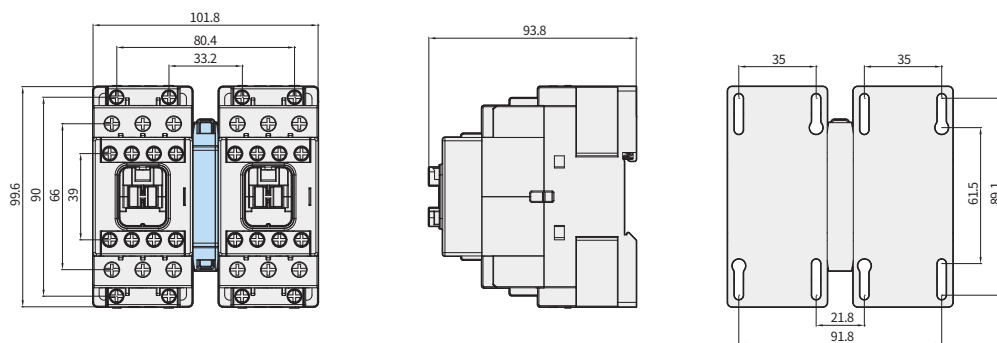

HGC65R

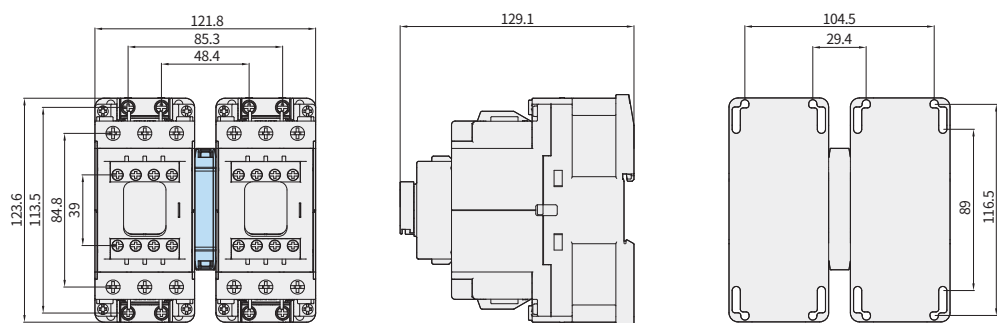

HGC100R

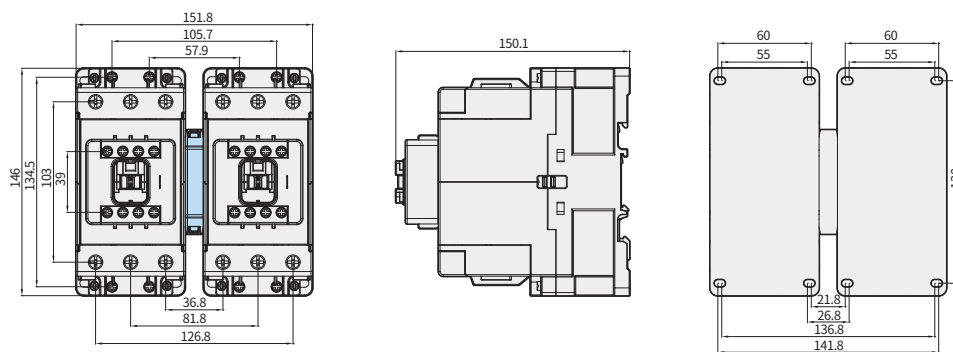

※ The dimensions of the drawing on this page may be subject to change without notice.

## Dimensions

### Reverse Operation Magnetic Contactor (With Interlock Unit)

Unit : mm

HGC150R

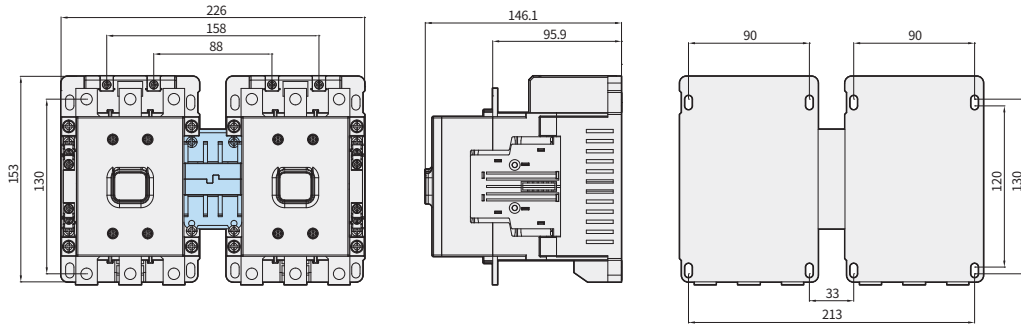

HGC265R

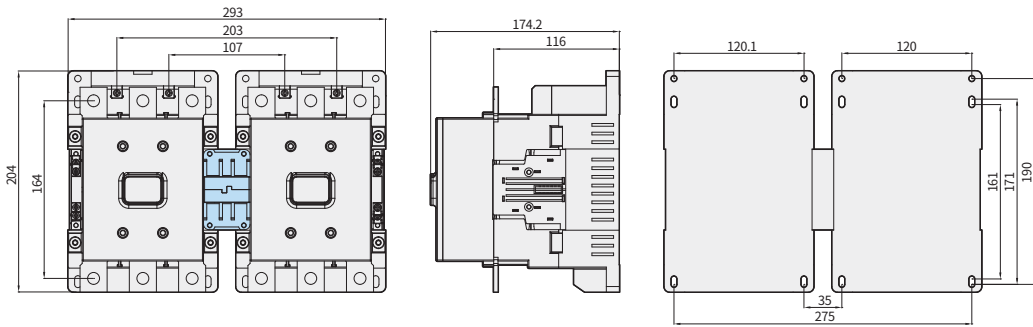

HGC500R

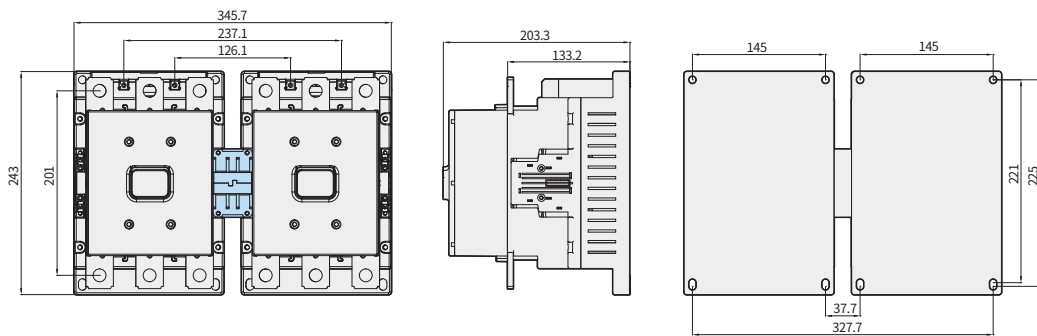

HGC800R

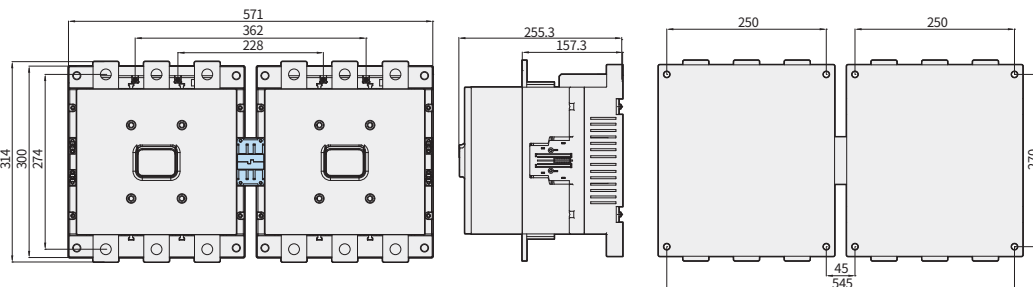

※ The dimensions of the drawing on this page may be subject to change without notice.

# Circuit Diagram

## Contact Arrangement

### Magnetic Contactor

Model Name	Auxiliary Contact		Contact Arrangement Diagram	
	Standard	Additional	AC	DC
HGC9 HGC12 HGC18 HGC25 HGC32 HGC40	2NO + 2NC	-		Same as left
HGC50 HGC65 HGC75 HGC85 HGC100	2NO + 2NC	2NO + 2NC		Same as left
HGC115 HGC130 HGC150 HGC185 HGC225 HGC265 HGC300 HGC400 HGC500 HGC630 HGC800	2NO + 2NC	-		Same as left
	2NO + 2NC (AC) 2NO + 1NC (DC)	2NO + 2NC		

### Control Relay

Model Name	Inspection Arrangement	Inspection Arrangement Drawing
HGR04	4NC	
HGR13	1NO + 3NC	
HGR22	2NO + 2NC	
HGR31	3NO + 1NC	
HGR40	4NO	

# Order Code

## Magnetic Contactor

HGC		12			22					
Model Name		Type and Capacity			Type and Capacity			Auxiliary Contact		
HGC	Magnetic Contactor	Standard Magnetic Contactor			Magnetic Contactor for Capacitor			Standard Magnetic Contactor		Applicable Type
		Code	Rated Current	Rated Capacity	Code	Rated Current	Capacitor (AC 440 V)			
		AC3/AC 400 V								
		9	9 A	4 kW	9C	9 A	9.7 kVAR	11	1NO + 1NC	HGC9A ~ 40A, AC or DC
		12	12 A	5.5 kW	12C	12 A	12.5 kVAR	21	2NO + 1NC	HGC50A ~ 100A, DC
		18	18 A	7.5 kW	18C	18 A	16.7 kVAR	22	2NO + 2NC	HGC9A ~ 40A, AC or DC HGC50A ~ 100A, AC HGC115A ~ 800A
		25	25 A	11 kW	25C	25 A	18 kVAR			
		32	32 A	15 kW	32C	32 A	30 kVAR			
		40	40 A	18.5 kW	40C	40 A	33.3 kVAR			
		50	50 A	22 kW	50C	50 A	45 kVAR			
		65	65 A	30 kW	65C	65 A	46 kVAR			
		75	75 A	37 kW	75C	75 A	54 kVAR			
		85	85 A	45 kW	85C	85 A	60 kVAR			
		100	100 A	55 kW	100C	100 A	80 kVAR			
		115	115 A	60 kW						
		130	130 A	65 kW						
		150	150 A	75 kW						
		185	185 A	90 kW						
		225	225 A	132 kW						
		265	265 A	147 kW						
		300	300 A	160 kW						
		400	400 A	220 kW						
		500	500 A	250 kW						
		630	630 A	330 kW						
		800	800 A	440 kW						
		For Nuclear								
		32Q	32 A							
		65Q	65 A							
		100Q	100 A							
		150Q	150 A							
		300Q	300 A							

※ The order format above is to explain the order code. For detailed specification per type, refer to the relevant page upon placing the order.

N		S		A		220		N	
Purpose		Terminal Type		Category of Operational Coil Voltage		Operational Coil Voltage		Purpose	
N	General	Standard Magnetic Contactor		Standard Magnetic Contactor		24	X, A AC 50/60 Hz	Non 1E Class	
		S	With Terminal Cover (9 ~ 100A)	X	AC 50 Hz (9 ~ 100 A)	48			
		Magnetic Contactor for Capacitor		A	AC 60 Hz (9 ~ 100 A)	110			
		S	With Terminal Cover			120			
				D	DC (9 ~ 100 A)	220			
						240			
						380			
						440			
				F	AC/DC (115 ~ 500 A)	24			
						48			
						110			
						125			
						220			
						220	AC 100 ~ 240 DC 110 ~ 220		
						440	AC 380 ~ 450		
						110	AC 100 ~ 127 DC 100 ~ 110		
						220	AC 200 ~ 240 DC 200 ~ 220		
						440	AC 380 ~ 450		
				Magnetic Contactor for Capacitor					
				X	AC 50 Hz				
				A	AC 60 Hz				

VCB

ACB

MCCB

MS

RELAY

## Order Code

### Thermal Overload Relay

HGT		18		K		A		18		S		N	
Model Name		Capacity of Contactor		No. of Terminal		Protection Grade (Characteristics Curve)		Setting Current		Terminal Type		Purpose	
HGT	Thermal Overload Relay	18	HGC9 ~ 18	K	3	A	10 A or 10	OP18	0.12 ~ 0.18 A	S	With Terminal Cover	N	Non 1E Class
		40	HGC25 ~ 40	H	2			OP26	0.18 ~ 0.26 A				
		65	HGC50, 65					OP35	0.25 ~ 0.35 A				
		100	HGC75 ~ 100					OP50	0.34 ~ 0.5 A				
		150	HGC115 ~ 150					OP70	0.5 ~ 0.7 A				
		265	HGC185 ~ 265					OP90	0.6 ~ 0.9 A				
		500	HGC300 ~ 500					1P20	0.8 ~ 1.2 A				
		800	HGC630 ~ 800					1P60	1.1 ~ 1.6 A				
		For Nuclear						2P10	1.5 ~ 2.1 A				
		40KQ	HGC18Q ~ 40Q					3	2 ~ 3 A				
		65KQ	HGC50Q ~ 65Q					4P20	2.8 ~ 4.2 A				
		100KQ	HGC75Q ~ 100Q					5	3 ~ 5 A				
		150KQ	HGC115Q ~ 150Q					6	4 ~ 6 A				
		500KQ	HGC300Q ~ 500Q					8	5.6 ~ 8 A				
								9	6 ~ 9 A				
								10	7 ~ 10 A				
								12	8 ~ 12 A				
								18	12 ~ 18 A				
								22	15 ~ 22 A				
								25	17 ~ 25 A				
						32	22 ~ 32 A						
						40	28 ~ 40 A						
						50	34 ~ 50 A						
						65	45 ~ 65 A						
						75	52 ~ 75 A						
						80	48 ~ 80 A						
						85	59 ~ 85 A						
						100	70 ~ 100 A						
						115	69 ~ 115 A						
						130	78 ~ 130 A						
						150	90 ~ 150 A						
						185	111 ~ 185 A						
						225	135 ~ 225 A						
						265	159 ~ 265 A						
						300	180 ~ 300 A						
						400	240 ~ 400 A						
						500	300 ~ 500 A						
						630	378 ~ 630 A						
						800	480 ~ 800 A						

※ The order format above is to explain the order code. For detailed specification per type, refer to the relevant page upon placing the order.

## Control Relay

HGR		22		N		S		A		220		N	
Model Name		Auxiliary Contact		Operation Method		Terminal Type		Category of Operational Coil Voltage		Operational Coil Voltage		Purpose	
<b>HGR</b>	Control Relay	<b>04</b>	4NC	<b>N</b>	AC	<b>S</b>	With Terminal Cover	<b>X</b>	AC 50 Hz	24 ~ 440 V		<b>N</b>	Non 1E Class
		<b>13</b>	1NO + 3NC	<b>P</b>	DC (Permanent magnetic)			<b>A</b>	AC 60 Hz				
		<b>22</b>	2NO + 2NC					<b>D</b>	DC				
		<b>31</b>	3NO + 1NC										
		<b>40</b>	4NO										
		Nuclear											
		<b>04Q</b>	0NO + 4NC										
		<b>13Q</b>	1NO + 3NC										
		<b>22Q</b>	2NO + 2NC										
		<b>31Q</b>	3NO + 1NC										
		<b>40Q</b>	4NO + 0NC										

※ The order format above is to explain the order code. For detailed specification per type, refer to the relevant page upon placing the order.

# Handling and Maintenance Inspection

## Storage and Transportation

### Storage Precaution

- | Ambient Temperature | - 5 ~ + 40 °C  
(Below the average daily temperature of 35 °C)
- | Altitude | Below 2,000 m above sea level
- | Relative Humidity | Within 45 % ~ 85 %

The surrounding environment may affect the insulation performance and durability of the magnetic contactor so the environment condition for usage must accurately be checked before application.



- **Relative humidity to be within the range of 45% ~ 85%**  
Do not store in places with high humidity for a long period of time.
- **Avoid places with a lot of dust**  
Do not store in exposed places and use cover or packing material to prevent dust from piling up on the circuit breaker.

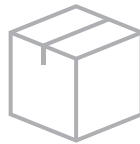

- **Store in packaged state**  
During storage, store in packaged state. Store in a state using shelf or equivalent devices and do not leave it neglected on the floor. Do not transport heavy products manually. It may cause injury.



- **Do not leave under direct sunlight for a long period of time.**



- **Avoid storage in high or low temperature**  
Storage temperature must be maintained between - 20 °C ~ + 60 °C.



- **Do not store in places with corrosive gas**  
Do not leave it around gas containing sulfurous gas or sulfur or ammonia gas and others.



- In case of mountainous region with high altitude, it may drop the insulation durability so check the adjustment coefficient of the insulation performance and use the appropriate ratings of the product.

### Transportation Precautions

#### ⚠ Caution

- Do not apply impact during transportation. Dropping or applying strong impact may cause defect.
- Do not handle while holding the circuit breaker's accessory or external plug-in wire of the accessory. It may cause injury in the handler or a malfunction of the circuit breaker.

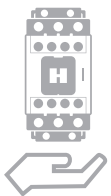

- **Hold the main unit of the circuit breaker during transportation**  
Do not handle while holding the external guide line of the accessory or the terminal bar.



- **Pay attention when handling metal accessories**  
Sharp planes or edges in the metal accessory may cause injury.

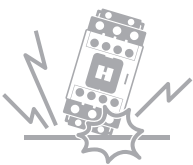

- **Do not apply impact during transportation**  
Dropping or applying strong impact may cause defect.

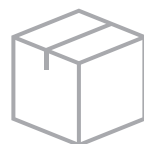

- **Pay attention to the packaging of the circuit breaker before transportation**  
Inappropriate packaging may cause damage in the circuit breaker during transportation.



## Installation

- Mount in dry places with less vibration.
- As for the installation direction, vertical installation is recommended but it can be used in each direction as seen in the figure.
- In case of cross installation and horizontal installation, it may drop the lifespan and various characteristics when compared to the normal installation.
- When using in a space below the insulation distance below, damage may be caused by the switching arc.

### Installation

Normal Installation

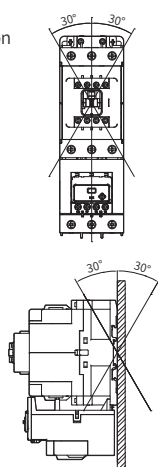

Cross Installation and Horizontal Installation

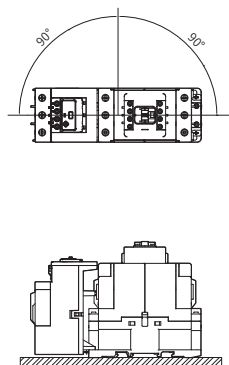

### Insulation Distance

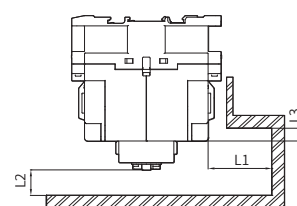

Unit : mm

Product	Above HGC75				
	HGC75 ~ 100	HGC115 ~ 150	HGC185 ~ 265	HGC300 ~ 500	HGC630 ~ 800
L1	30	30	80	80	80
L2	5	15	15	15	20
L3	6	11	32	32	40

## Handling Precautions

### Caution

- Do not store and use in abnormal environment such as high temperature, high humidity, dust, corrosive gas, vibration, impact and others. It may cause electric shock, fire and malfunction.
- Ensure that rubbish, foreign substances such as concrete powder, metal powder, rainwater and others do not flow in.
- When handling the product, do not use lubricants. It may cause electric shock and fire.
- Electrical works must be conducted by qualified technicians with certifications related to electrical works. It may cause electric shock and fire.

### Inspection Items Before Use

- Ensure that calibration work is not skipped. It may cause malfunction.

### Installation, Usage and Maintenance Precautions

- Frequently check the fastening state, assembly and combination status of the bolt. It may cause electric shock, fire and malfunction.
- Check whether the rated current, voltage and frequency conform to the intended specification. It may cause electric shock, fire and malfunction.
- As for the wiring work, check whether the upper circuit breaker has been turned off so that electricity does not flow. It may cause electric shock.
- Connect the power that conforms to the ratings of the switch/contactors' main unit. It may cause fire and malfunction.
- As for the wiring and terminal, use the standard product and as for the terminal screw, fasten using the torque indicated in the user manual. It may cause fire.
- Frequently check the wiring state and shape. It may cause electric shock, fire and malfunction.
- Check whether parts have been omitted and replace damaged products and parts. It may cause electric shock, fire and malfunction.
- In case of abnormality in the contact, replace immediately and do not arbitrarily process such as trimming the contact using string or use lubricant. It may cause electric shock, fire and malfunction.
- Use the specified tool. It may cause damage and malfunction.

# Handling and Maintenance Inspection

## Storage and Transportation

### Installation Precautions



- Do not block the arc gas exhaust hole. It may drop the breaking capacity.



- Pay attention to dust, metal scraps and others. After installation, cover the protection cover while working with the machine.

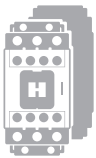

- Do not remove the insulation plate attached at the bottom of the circuit breaker. It may destroy the insulation and the insulation performance.

### Connection Precautions



- When fastening the terminal screw, it should be fastened according to the specified torque. Incomplete fastening of the terminal screw may cause overheating so each terminal screw must be fastened completely according to the specified torque. In addition, excessive fastening torque may cause damage in the terminal screw and the circuit breaker case.



- Use of lubricant at the terminal screw part is prohibited. Lubricant reduces the friction of the screw, causing the screw to loosen, ultimately leading to an increase in temperature.



- Exposed conductor must be insulated. Insulating tube or insulating tape must be used to complete insulation between the bare conductors of the MC. In case the terminals are not insulated, it may cause secondary short-circuit during short-circuit accidents.



- STUD must not be deformed. Excessive force must not be applied to the stud at the conductor connecting part of the rear connection type. In addition, stud must not be deformed during wiring.

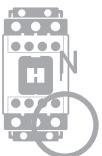

- In case of 4 pole circuit breaker, the neutral wire of 3 phase 4 wire must be connected to the N phase. It may not function in overcurrent which may cause fire.







- The conductor must be fixed firmly on a flat state. As for the connecting conductor, electromagnetic force between conductors is generated by extremely big fault current so it must be fixed firmly.

# Current Status of Acquired Standards

## Approvals & Certificates

MS

● : Acquired  
 ◎ : In Progress (Expected)

Type of Certification	Approvals			Certificate	
Type of Standard	Safety Certificate	IEC	IEC	IEC	GB
Mark					
Testing Institute	KETI	CE	KTC	Nuclear	GB 1984
Certification Country	Korea	Europe	Korea	Korea	China
HGC9	●	●	●		●
HGC12	●	●	●		●
HGC18	●	●	●		●
HGC25	●	●	●		●
HGC32	●	●	●	◎	●
HGC40	●	●	●		●
HGC50	●	●	●		●
HGC65	●	●	●	◎	●
HGC75	●	●	●		●
HGC85	●	●	●		●
HGC100	●	●	●	◎	●
HGC115	●	●	●		●
HGC130	●	●	●		●
HGC150	●	●	●	◎	●
HGC185	●	●	●		●
HGC225	●	●	●		●
HGC265	●	●	●		●
HGC300	●	●	●	◎	●
HGC400		●	●		●
HGC500		●	●		●
HGC630		●	●		●
HGC800		●	●		●
HGR		●		◎	●
HGCTB		●		◎	●
HGT18		●	●		●
HGT40		●	●	◎	●
HGT65		●	●	◎	●
HGT100		●	●	◎	●
HGT150		●	●	◎	●
HGT265		●	●		●
HGT500		●	●	◎	●
HGT800		●	●		●

VCB

ACB

MCCB

MS





RELAY

## Current Status of Acquired Standards



### Approvals & Marine Certificates

#### MS

● : Acquired  
 ◎ : In Progress (Expected)

Type of Certification	Marine			
Type of Standard	Korea	U.K.	USA	France
Mark				
Testing Institute	KR	LR	ABS	BV
Certification Country	Korea	U.K.	USA	France
HGC9	●	●	●	●
HGC12	●	●	●	●
HGC18	●	●	●	●
HGC25	●	●	●	●
HGC32	●	●	●	●
HGC40	●	●	●	●
HGC50	●	●	●	●
HGC65	●	●	●	●
HGC75	●	●	●	●
HGC85	●	●	●	●
HGC100	●	●	●	●
HGC115	●	●	●	●
HGC130	●	●	●	●
HGC150	●	●	●	●
HGC185	●	●	●	●
HGC225	●	●	●	●
HGC265	●	●	●	●
HGC300	●	●	●	●
HGC400	●	●	●	●
HGC500	●	●	●	●
HGC630	●	●	●	●
HGC800	●	●	●	●
HGR	●	●	●	●
HGCTB	●	●	●	●
HGT18	●	●	●	●
HGT40	●	●	●	●
HGT65	●	●	●	●
HGT100	●	●	●	●
HGT150	●	●	●	●
HGT265	●	●	●	●
HGT500	●	●	●	●
HGT800	●	●	●	●

● : Acquired  
 ◎ : In Progress (Expected)

Type of Certification	Marine		
Type of Standard	Japan	Germany	Italy
Mark			
Testing Institute	NK	GL	RINA
Certification Country	Japan	Germany	Italy
HGC9	●	●	●
HGC12	●	●	●
HGC18	●	●	●
HGC25	●	●	●
HGC32	●	●	●
HGC40	●	●	●
HGC50	●	●	●
HGC65	●	●	●
HGC75	●	●	●
HGC85	●	●	●
HGC100	●	●	●
HGC115	●	●	●
HGC130	●	●	●
HGC150	●	●	●
HGC185	●	●	●
HGC225	●	●	●
HGC265	●	●	●
HGC300	●	●	●
HGC400	●	●	●
HGC500	●	●	●
HGC630	●	●	●
HGC800	●	●	●
HGR		●	
HGCTB		●	
HGT18		●	●
HGT40		●	●
HGT65		●	●
HGT100		●	●
HGT150		●	●
HGT265		●	●
HGT500		●	●
HGT800		●	●

VCB

ACB

MCCB

MS

RELAY

