

Top 100
Global
Innovator
for 10 years

Metasol Meta Solution

MC/TOR

Contactors and Overload Relays



LS ELECTRIC

Metasol Contactors and overload relays

New Generation of Contactors From LS



Designed to show superior technology: Metasol series

Sealed structure has improved its safety features so that no arc flash is exposed. In order to emphasize its durability as an industrial device, Metasol series adopt simple design form and sophisticated shape applying diamond cut concepts on product surface.



Contents

| | |
|--|-----|
| Table of specifications | 10 |
| Type numbering system | 20 |
| Environment | 22 |
| Connections | 23 |
| Control coil characteristics | 24 |
| Marking | 28 |
| Internal structure | 29 |
| Contactors | 30 |
| Motor starters | 54 |
| Reversing contactors | 58 |
| LED voltage monitoring contactor | 60 |
| Contactor relays | 61 |
| Latching contactors | 64 |
| 4-pole contactors | 68 |
| Enclosed motor starters, Mold enclosure | 80 |
| Enclosed motor starters, Steel enclosure | 81 |
| Capacitor contactors | 82 |
| 2-pole AC contactors, Definite purpose | 83 |
| 3-pole AC contactors, Definite purpose | 84 |
| Single-pole AC contactors, Definite purpose | 85 |
| 2-pole DC contactors | 86 |
| Accessory | 87 |
| Overload relays | 98 |
| Overload relay specifications | 100 |
| Overload relay operation | 104 |
| Accessories for overload relay | 105 |
| Overload relay ordering types | 110 |
| Overload relay trip curves | 116 |
| Type 2 coordination (440V) | 124 |
| Rated UL 508 combination motor controller Type-C | 131 |
| Rated UL 508 combination motor controller Type-D | 135 |
| Rated UL 508 combination motor controller Type-F | 138 |
| Ready for IE3 | 141 |
| Dimension | 142 |
| Delayed opening device | 179 |
| Electronic timer unit | 180 |
| Contact arrangement | 181 |
| Comparison table | 183 |
| Certifications | 189 |

Metasol Series completion



More Safe,
More Valuable



Contactors & Overload Relays



- *Advanced technology & Expert solution*
- *Offering economical solution with compact size & easy connection*
- *Ensure reliability in the system: Type II Coordination*
- *Perfect system with peripheral devices.*
- *Environment friendly product: complies with International environment standard RoHS.*
- *25 Models in 9 Frames*
- *Ready for IE3*

Contactors and overload relays

Motor Starters

- Compact design for space saving
- DIN rail and screw mountable (upto 150AF)
- Overload relays directly mountable to contactors separately
- Finger-proof design
- Easy to combine with manual motor starters
- Broad range of accessories
- World class products conforming to IEC and UL standards



18AF

Contactor

MC-6a, 9a, 12a, 18a

Rated current:
6, 9, 12, 18A

Rated insulation voltage:
690V

Overload relay MT-12

Current range: 0.1~18A
Trip class: Class10A, 20

22AF

Contactor

MC-9b, 12b, 18b, 22b

Rated current:
9, 12, 18, 22A

Rated insulation voltage:
690V

Overload relay MT-32

Current range: 0.1~40A
Trip class: Class10A, 20

40AF

Contactor

MC-32a, 40a

Rated current:
32, 40A

Rated insulation voltage:
1000V

Overload relay MT-32

Current range: 0.1~40A
Trip class: Class10A, 20

65AF

Contactor

MC-50a, 65a

Rated current:
50, 65A

Rated insulation voltage:
1000V

Overload relay MT-63

Current range: 4~65A
Trip class: Class10A, 20

100AF

Contactor

MC-75a, 85a, 100a

Rated current:
75, 85, 100A

Rated insulation voltage:
1000V

Overload relay MT-95

Current range: 7~100A
Trip class: Class10A, 20

150AF

Contactor

MC-130a, 150a

Rated current:
130, 150A

Rated insulation voltage:
1000V

Overload relay MT-150

Current range: 34~150A
Trip class: Class10A, 20

MS-500a, MS-630a, MS-800a

MS-185a, MS-225a

MS-265a, MS-330a, MS-400a



225AF



400AF



800AF

225AF

Contactor

MC-185a, 225a

Rated current:

185, 225A

Rated insulation voltage:
1000V

Overload relay MT-225

Current range: 65~240A

Trip class: Class10A, 20

400AF

Contactor

MC-265a, 330a, 400a

Rated current:

265, 330, 400A

Rated insulation voltage:
1000V

Overload relay MT-400

Current range: 85~400A

Trip class: Class10A, 20

800AF

Contactor

MC-500a, 630a, 800a

Rated current:

500, 630, 800A

Rated insulation voltage:
1000V

Overload relay MT-800

Current range: 200~800A

Trip class: Class10A, 20

1260AF

Contactor

MC-1260a

Rated current:

1260A

Rated insulation voltage:
1000V

2650AF

Contactor

**MC-1400a, 1700a, 2100a,
2650a**

Rated current:

1400, 1700, 2100, 2650A

Rated insulation voltage:
1000V



MC/TOR Accessories

Perfect combination of peripheral devices and various accessories

Offering economical solution with compact size & easy connection



Perfect system with other devices and accessories

■ One-touch connection

- Din Rail connection without any special tools
- Direct combine a surge unit

■ Simple wiring

- Mounting unit, Adapter
- Reversing wire set

■ Easy maintenance

- 4-terminal type: Easy wiring of operation coil
- Module type of screw terminal
- Interlock unit with built-in auxiliary contacts(2NO built-in)

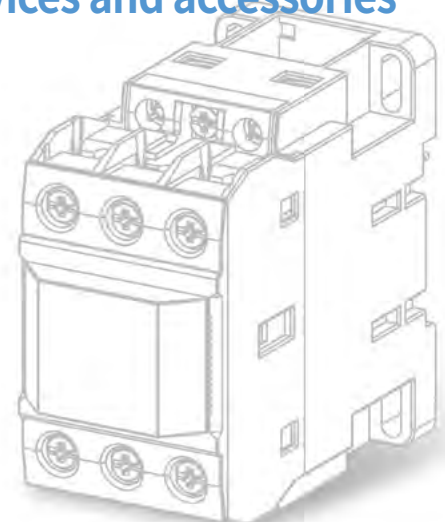

Advanced accessories for Metasol contactors

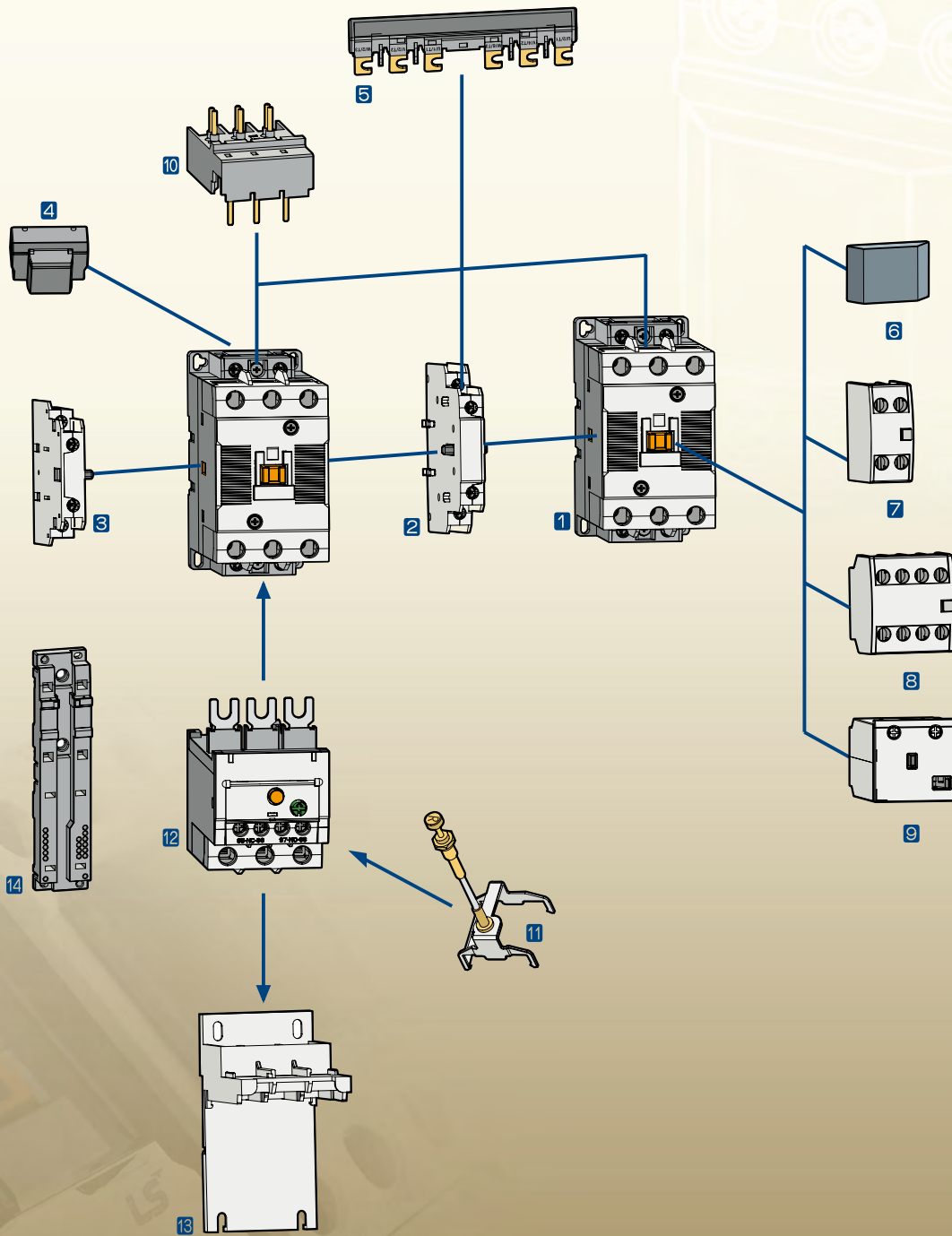

- | | | |
|--|---|-----------------------------------|
| 1 Contactor | 6 Safety cover (Option) | 10 Direct adaptor to MMS |
| 2 Interlock unit | 7 Auxiliary contact unit - front mount(2p) | 11 Remote reset unit |
| 3 Auxiliary contact unit - side mount | 8 Auxiliary contact unit - front mount(4p) | 12 Overload relay |
| 4 Surge unit | 9 Mechanical latch unit | 13 Separate mounting unit |
| 5 Wire kit | | 14 Mounting unit for use with MMS |

Table of specifications

MC type Magnetic Contactors



| Frame size | | 18AF | | | | 22AF | | | | |
|--|------------------------|--------------------------|-------|--------|--------|--------------------------|--------------|--------|--------|-----|
| Type | Screws clamp terminals | MC-6a | MC-9a | MC-12a | MC-18a | MC-9b | MC-12b | MC-18b | MC-22b | |
| | Lug clamp terminals | ● | ● | ● | ● | ● | ● | ● | ● | |
| Number of poles | | 3pole | | | | 3pole | | | | |
| Rated operational voltage(Ue) | | 690V | | | | 690V | | | | |
| Rated insulation voltage(Ui) | | 690V | | | | 690V | | | | |
| Rated frequency | | 50/60Hz | | | | 50/60Hz | | | | |
| Rated impulse withstand voltage, Uimp | | 6kV | | | | 6kV | | | | |
| Maximum operating rate in operating cycles per hour(AC3) | | 1800 operations per hour | | | | 1800 operations per hour | | | | |
| Durability | Mechanical | 15 mil. operations | | | | 15 mil. operations | | | | |
| | Electrical | 2.5 mil. operations | | | | 2.5 mil. operations | | | | |
| Current power | AC-1, Thermal current | [A] | 25 | 25 | 25 | 32 | 25 | 27 | 40 | 45 |
| | AC-3 200/240V | [kW] | 2.2 | 2.5 | 3.5 | 4.5 | 2.5 | 3.5 | 4.5 | 5.5 |
| | | [A] | 9 | 11 | 13 | 18 | 11 | 13 | 18 | 22 |
| | 380/440V | [kW] | 3 | 4 | 5.5 | 7.5 | 4 | 5.5 | 7.5 | 11 |
| | | [A] | 7 | 9 | 12 | 18 | 9 | 12 | 18 | 22 |
| | 500/550V | [kW] | 3 | 4 | 7.5 | 7.5 | 4 | 7.5 | 7.5 | 15 |
| | | [A] | 6 | 7 | 12 | 13 | 7 | 12 | 13 | 20 |
| | 690V | [kW] | 3 | 4 | 7.5 | 7.5 | 4 | 7.5 | 7.5 | 15 |
| | | [A] | 4 | 5 | 9 | 9 | 6 | 9 | 9 | 18 |
| | 1000V | [kW] | - | - | - | - | - | - | - | - |
| [A] | | - | - | - | - | - | - | - | - | |
| Rated Short-time withstand current (IEC 60947) | 1s | [A] | 210 | 250 | 280 | 300 | 250 | 280 | 300 | 400 |
| | 10s | [A] | 105 | 110 | 120 | 130 | 110 | 120 | 154 | 186 |
| | 30s | [A] | 70 | 70 | 80 | 85 | 70 | 80 | 100 | 130 |
| | 1min | [A] | 61 | 61 | 61 | 70 | 61 | 61 | 84 | 90 |
| | 3min | [A] | 40 | 45 | 47 | 50 | 45 | 50 | 60 | 60 |
| | 10min | [A] | 30 | 30 | 30 | 40 | 30 | 30 | 40 | 50 |
| | ≥15min | [A] | 25 | 26 | 28 | 30 | 26 | 28 | 30 | 45 |
| UL rating (50/60Hz) | Continuous current | [A] | 25 | 25 | 25 | 32 | 25 | 25 | 40 | 40 |
| | Single phase 110~120V | [HP] | 0.5 | 0.5 | 1 | 2 | 0.5 | 1 | 2 | 2 |
| | | [HP] | 1.5 | 1.5 | 2 | 3 | 1.5 | 2 | 3 | 3 |
| | Three phase 200~208V | [HP] | 2 | 2 | 3 | 7.5 | 2 | 3 | 7.5 | 7.5 |
| | | [HP] | 3 | 3 | 5 | 7.5 | 3 | 5 | 7.5 | 10 |
| | 440~480V | [HP] | 5 | 5 | 7.5 | 10 | 5 | 7.5 | 10 | 15 |
| | | [HP] | 7.5 | 7.5 | 10 | 15 | 7.5 | 10 | 15 | 20 |
| NEMA size | | 00 | 00 | 0 | 1 | 00 | 0 | 1 | | |
| Size and weight | AC control | Weight | [kg] | | | | 0.33 | | | |
| | | Size(W×H×D) | [mm] | | | | 45×73.5×80.4 | | | |
| | DC control | Weight | [kg] | | | | 0.41 | | | |
| | | Size(W×H×D) | [mm] | | | | 45×73.5×96.6 | | | |
| Auxiliary(Standard) | | 1a or 1b | | | | 1a1b | | | | |
| Auxiliary | Side mount | UA-1 | | | | UA-1 | | | | |
| | Front mount | UA-2, UA-4 | | | | UA-2, UA-4 | | | | |

Note) Minimum conduct current of Auxiliary contactor is DC 17V5mA.

MT type Thermal Overload Relays



| Type | MT-12/□ | MT-32/□ | | |
|---------------------------------------|------------------------|---------|--------------|----------|
| Type | Screws clamp terminals | ● | ● | |
| | Lug clamp terminals | | | |
| Rated operational voltage, Ue | | 690V | 690V | |
| Rated insulation voltage, Ui | | 690V | 690V | |
| Rated impulse withstand voltage, Uimp | | 6kV | 6kV | |
| Trip class | | 10A, 20 | 10A, 20 | |
| Setting range | | 0.1~18A | 0.1~40A | |
| Size and weight | Weight | [kg] | 0.1 | 0.17 |
| | Size(W×H×D) | [mm] | 45×73.2×63.7 | 45×75×90 |

* The safety cover of magnetic contactor and thermal overload relay is optional.



| 40AF | | 65AF | | 100AF | | |
|--------------------------|--------|--------------------------|--------|--------------------------|--------|-------------------|
| MC-32a | MC-40a | MC-50a | MC-65a | MC-75a | MC-85a | MC-100a |
| ● | ● | ● | ● | ● | ● | ● |
| 3pole | | 3pole | | 3pole | | |
| 1000V | | 1000V | | 1000V | | |
| 1000V | | 1000V | | 1000V | | |
| 50/60Hz | | 50/60Hz | | 50/60Hz | | |
| 8kV | | 8kV | | 8kV | | |
| 1800 operations per hour | | 1200 operations per hour | | 1200 operations per hour | | |
| 12 mil. operations | | 12 mil. operations | | 12 mil. operations | | |
| 2 mil. operations | | 2 mil. operations | | 2 mil. operations | | 1 mil. operations |
| 55 | 60 | 100 | 115 | 125 | 135 | 160 |
| 7.5 | 11 | 15 | 18.5 | 22 | 25 | 30 |
| 32 | 40 | 55 | 65 | 75 | 85 | 105 |
| 15 | 18.5 | 22 | 30 | 37 | 45 | 55 |
| 32 | 40 | 50 | 65 | 75 | 85 | 105 |
| 18.5 | 22 | 30 | 33 | 37 | 45 | 55 |
| 28 | 32 | 43 | 60 | 64 | 75 | 85 |
| 18.5 | 22 | 30 | 33 | 37 | 45 | 55 |
| 20 | 23 | 28 | 35 | 42 | 45 | 65 |
| 22 | 22 | 30 | 30 | 37 | 37 | 37 |
| 17 | 17 | 23 | 23 | 28 | 28 | 28 |
| 600 | 700 | 1000 | 1050 | 1100 | 1200 | 1320 |
| 260 | 300 | 550 | 700 | 750 | 800 | 900 |
| 160 | 190 | 330 | 380 | 400 | 450 | 500 |
| 100 | 120 | 250 | 270 | 300 | 350 | 400 |
| 70 | 80 | 150 | 200 | 220 | 270 | 270 |
| 55 | 65 | 90 | 120 | 140 | 170 | 180 |
| 50 | 60 | 87 | 96 | 114 | 150 | 160 |
| 50 | 60 | 70 | 100 | 110 | 135 | 160 |
| 3 | 3 | 3 | 5 | 5 | 7.5 | 10 |
| 5 | 7.5 | 10 | 15 | 15 | 15 | 20 |
| 7.5 | 15 | 20 | 25 | 25 | 30 | 30 |
| 10 | 15 | 25 | 30 | 30 | 40 | 40 |
| 20 | 30 | 40 | 50 | 50 | 60 | 75 |
| 25 | 30 | 50 | 60 | 60 | 75 | 75 |
| 1P | 2 | | | | 3 | |
| 0.55 | | 1.05 | | 1.93 | | |
| 69×83×90 | | 79×106×119 | | 94×140×135.8 | | |
| 0.77 | | 1.3 | | 2.8 | | |
| 69×83×117.1 | | 79×106×146.4 | | 94×140×172.3 | | |
| 2a2b | | 2a2b | | 2a2b | | |
| UA-1 | | UA-1 | | UA-1 | | |
| UA-2, UA-4 | | UA-2, UA-4 | | UA-2, UA-4 | | |



| MT-32/□ | MT-63/□ | MT-95/□ |
|----------|-----------|-----------|
| ● | ● | ● |
| 690V | 690V | 690V |
| 690V | 690V | 690V |
| 6kV | 6kV | 6kV |
| 10A, 20 | 10A, 20 | 10A, 20 |
| 0.1~40A | 4~65A | 7~100A |
| 0.17 | 0.31/0.33 | 0.48/0.5 |
| 45×75×90 | 55×81×100 | 70×97×110 |

Table of specifications

MC type Magnetic Contactors



| Frame size | | | 150AF | | 225AF | | 400AF | | |
|--|------------------------|------------------|--------------------------|---------|----------------------------|---------|----------------------------|---------|---------------------|
| Type | | | MC-130a | MC-150a | MC-185a | MC-225a | MC-265a | MC-330a | MC-400a |
| | Screws clamp terminals | | ● | ● | ● | ● | ● | ● | ● |
| | Lug clamp terminals | | ● | ● | ● | ● | | | |
| Number of poles | | | 3pole | | 3pole | | 3pole | | |
| Rated operational voltage(Ue) | | | 1000V | | 1000V | | 1000V | | |
| Rated insulation voltage(Ui) | | | 1000V | | 1000V | | 1000V | | |
| Rated frequency | | | 50/60Hz | | 50/60Hz | | 50/60Hz | | |
| Rated impulse withstand voltage, Uimp | | | 8kV | | 8kV | | 8kV | | |
| Maximum operating rate in operating cycles per hour(AC3) | | | 1200 operations per hour | | 1200 operations per hour | | 1200 operations per hour | | |
| Durability | Mechanical | | 5 mil. operations | | 5 mil. operations | | 5 mil. operations | | 2.5 mil. operations |
| | Electrical | | 1 mil. operations | | 1 mil. operations | | 1 mil. operations | | 0.5 mil. operations |
| Current and power | AC-1, Thermal current | [A] | 200 | 250 | 300 | 350 | 400 | 500 | 520 |
| | | [kW] | 37 | 45 | 55 | 75 | 80 | 90 | 125 |
| | AC-3 200/240V | [A] | 130 | 150 | 185 | 225 | 265 | 330 | 400 |
| | | [kW] | 60 | 75 | 90 | 132 | 147 | 160 | 200 |
| | 380/440V | [A] | 130 | 150 | 185 | 225 | 265 | 330 | 400 |
| | | [kW] | 60 | 70 | 110 | 132 | 147 | 160 | 225 |
| | 500/550V | [A] | 90 | 100 | 180 | 200 | 225 | 280 | 350 |
| | | [kW] | 55 | 55 | 110 | 140 | 160 | 200 | 250 |
| | 690V | [A] | 60 | 60 | 120 | 150 | 185 | 220 | 300 |
| | | [kW] | 75 | 75 | 132 | 132 | 147 | 147 | 147 |
| | 1000V | [A] | 50 | 50 | 90 | 90 | 105 | 105 | 105 |
| | | [kW] | | | | | | | |
| Rated Short-time withstand current (IEC 60947) | 1s | [A] | 1350 | 1800 | 2000 | 2500 | 3500 | 4000 | 4600 |
| | 10s | [A] | 950 | 1200 | 1500 | 1700 | 2400 | 3000 | 4400 |
| | 30s | [A] | 700 | 800 | 1000 | 1200 | 1500 | 2500 | 2974 |
| | 1min | [A] | 550 | 600 | 800 | 1000 | 1100 | 1700 | 1846 |
| | 3min | [A] | 350 | 450 | 520 | 700 | 800 | 1000 | 1313 |
| | 10min | [A] | 200 | 300 | 350 | 500 | 600 | 620 | 760 |
| | ≥15min | [A] | 175 | 280 | 320 | 400 | 500 | 553 | 699 |
| UL rating (50/60Hz) | Continuous current | [A] | 200 | 250 | 300 | 350 | 400 | 500 | 520 |
| | | [HP] | 10 | 15 | 15 | 15 | - | - | - |
| | Single phase 110~120V | [HP] | 20 | 25 | 30 | 40 | - | - | - |
| | | [HP] | 40 | 40 | 60 | 60 | 75 | 100 | 125 |
| | Three phase 220~240V | [HP] | 40 | 50 | 60 | 75 | 100 | 100 | 150 |
| | | [HP] | 75 | 100 | 125 | 150 | 200 | 200 | 300 |
| | 440~480V | [HP] | 75 | 75 | 125 | 150 | 200 | 200 | 300 |
| | | [HP] | | | | | | | |
| 550~600V | [HP] | | | | | | | | |
| | [HP] | | | | | | | | |
| Size and weight | AC control | Weight [kg] | 2.4 | | 5.4 | | 9.2 | | |
| | | Size(W×H×D) [mm] | 119×158×130.3 | | 138×203×185.1 | | 163×243×204.4 | | |
| | DC control | Weight [kg] | 2.4 | | 5.4 | | 9.2 | | |
| | | Size(W×H×D) [mm] | 119×158×130.3 | | 138×203×185.1 | | 163×243×204.4 | | |
| Auxiliary(Standard) | | | 2a2b | | 2a2b | | 2a2b | | |
| Auxiliary | Side mount | | UA-1 | | AU-100, AU-100E (Max.4a4b) | | AU-100, AU-100E (Max.4a4b) | | |
| | Front mount | | UA-2, UA-4 | | - | | - | | |

MT type Thermal Overload Relays



| Type | | MT150/□ | MT225/□ | MT400/□ |
|---------------------------------------|------------------------|------------|-------------|-------------|
| | Screws clamp terminals | ● | ● | ● |
| | Lug clamp terminals | ● | ● | |
| Rated operational voltage, Ue | | 690V | 690V | 690V |
| Rated insulation voltage, Ui | | 690V | 690V | 690V |
| Rated impulse withstand voltage, Uimp | | 6kV | 6kV | 6kV |
| Trip class | | 10A, 20 | 10A, 20 | 10A, 20 |
| Setting range | | 34~150A | 65~240A | 85~400A |
| Size and weight | Weight [kg] | 0.67 | 2.5 | 2.6 |
| | Size(W×H×D) [mm] | 95×109×113 | 147×141×184 | 151×171×198 |

* The safety cover of magnetic contactor and thermal overload relay is optional.



| 800AF | | | 1260AF | 2650AF | | | |
|----------------------------|---------|---------|----------------------------|----------------------------|----------|----------|----------------------|
| MC-500a | MC-630a | MC-800a | MC-1260a | MC-1400a | MC-1700a | MC-2100a | MC-2650a |
| ● | ● | ● | ● | ● | ● | ● | ● |
| 3pole | | | 3pole | 3pole | | | |
| 1000V | | | 1000V | 1000V | | | |
| 1000V | | | 1000V | 1000V | | | |
| 50/60Hz | | | 50/60Hz | 50/60Hz | | | |
| 8kV | | | 8kV | 8kV | | | |
| 1200 operations per hour | | | 300 operations per hour | 300 operations per hour | | | |
| 2.5 mil. operations | | | 0.5 mil. operations | 0.5 mil. operations | | | 0.3 mil. operations |
| 0.5 mil. operations | | | 0.05 mil. operations | 0.05 mil. operations | | | 0.02 mil. operations |
| 700 | 900 | 1050 | 1260 | 1400 | 1700 | 2100 | 2650 |
| 147 | 190 | 220 | - | 290 | 310 | - | - |
| 500 | 630 | 800 | - | 860 | 1050 | - | - |
| 265 | 330 | 440 | - | 550 | 700 | 900 | - |
| 500 | 630 | 800 | - | 860 | 1050 | 1450 | - |
| 265 | 330 | 500 | - | - | - | - | - |
| 400 | 500 | 720 | - | - | - | - | - |
| 300 | 400 | 500 | - | 800 | 1000 | - | - |
| 380 | 420 | 630 | - | 800 | 950 | - | - |
| 280 | 280 | 280 | - | - | - | - | - |
| 220 | 220 | 220 | - | - | - | - | - |
| 6000 | 7000 | 7500 | 8000 | - | - | - | - |
| 5050 | 6400 | 7000 | 7200 | 8000 | 10000 | 10000 | - |
| 4400 | 4500 | 4900 | 5200 | - | - | - | - |
| 3400 | 3500 | 3800 | 4000 | 4500 | 5500 | 5500 | - |
| 2000 | 2200 | 2500 | 2300 | - | - | - | - |
| 1400 | 1550 | 1550 | 3000 | 2600 | 3000 | 3000 | - |
| 1100 | 1300 | 1300 | 1500 | - | - | - | - |
| 700 | 900 | 1050 | 1260 | 1400 | 1700 | 2100 | 2650 |
| - | - | - | - | - | - | - | - |
| - | - | - | - | - | - | - | - |
| 150 | 200 | 200 | - | - | - | - | - |
| 200 | 250 | 300 | - | - | - | - | - |
| 400 | 500 | 600 | - | - | - | - | - |
| 400 | 500 | 600 | - | - | - | - | - |
| 6 | | 7 | | | | | |
| 22.2 285×310×246 | | | 24 285×352×246 | 33.8 431×380×246 | | | 47 431×392×246 |
| 22.2 285×310×246 | | | 24 285×352×246 | 33.8 431×380×246 | | | 47 431×392×246 |
| 2a2b | | | 2a2b | 2a2b | | | |
| AU-100, AU-100E (Max.4a4b) | | | AU-100, AU-100E (Max.4a4b) | AU-100, AU-100E (Max.4a4b) | | | |
| - | | | - | - | | | |



| MT-800/□ | |
|-------------|--|
| ● | |
| 690V | |
| 690V | |
| 6kV | |
| 10A, 20 | |
| 200~800A | |
| 11.5 | |
| 360×530×212 | |

Table of specifications



MC type Magnetic Contactors (4pole)

| Frame size | | | | 18AF | | | | |
|--|----------------------|-------------|---------------------|--------------|---------------------|----------|--------------------------|--|
| Type | | | MC-6a/4 | MC-9a/4 | MC-12a/4 | MC-18a/4 | | |
| | Screw clamp terminal | | | | | | ● | |
| Number of poles | | | | | | | 4pole | |
| Rated operational voltage (Ue) | | | | | | | 690V | |
| Rated insulation voltage (Ui) | | | | | | | 690V | |
| Rated frequency | | | | | | | 50/60Hz | |
| Rated impulse withstand voltage, Uimp | | | | | | | 6kV | |
| Maximum operating rate in operating cycles per hour(AC1) | | | | | | | 1800 operations per hour | |
| Durability | Mechanical | | 15 mil. operations | | | | | |
| | Electrical | | 0.5 mil. operations | | 0.8 mil. operations | | | |
| Current and power | Thermal current | [A] | 25 | 25 | 25 | 40 | | |
| | | [kW] | 9 | 9 | 9 | 15 | | |
| | AC-1 | 200/240V | [A] | 25 | 25 | 25 | 40 | |
| | | 380/400V | [kW] | 17 | 17 | 17 | 27 | |
| | 500/550V | [A] | 25 | 25 | 25 | 40 | | |
| | | [kW] | 21 | 21 | 21 | 35 | | |
| | 690V | [A] | 25 | 25 | 25 | 40 | | |
| | | [kW] | 27 | 27 | 27 | 44 | | |
| UL rating (50/60Hz) | Continuous current | [A] | 25 | 25 | 25 | 32 | | |
| | Single | 110~120V | [HP] | 0.5 | 0.5 | 0.75 | 1 | |
| | Phase | 220~240V | [HP] | 1.5 | 1.5 | 2 | 3 | |
| | Three | 200~208V | [HP] | 2 | 2 | 3 | 7.5 | |
| | Phase | 220~240V | [HP] | 3 | 3 | 5 | 7.5 | |
| | | 440~480V | [HP] | 5 | 5 | 7.5 | 10 | |
| | | 550~600V | [HP] | 7.5 | 7.5 | 10 | 15 | |
| Size and weight | AC | Weight | [kg] | 0.33 | | | | |
| | Control | Size(W×H×D) | [mm] | 45×73.5×80.4 | | | | |
| | DC | Weight | [kg] | 0.4 | | | | |
| | Control | Size(W×H×D) | [mm] | 45×73.5×96.6 | | | | |
| Auxiliary(Standard) | | | | - | | | | |
| Auxiliary | Side mount | | | | | | UA-1 | |
| | Front mount | | | | | | UA-2, UA-4 | |



| | 22AF | 40AF | | 85AF | | | |
|--|--------------------|--------------------------|----------|--------------------------|----------|----------|----------|
| | MC-22a/4 | MC-32a/4 | MC-40a/4 | MC-50a/4 | MC-65a/4 | MC-75a/4 | MC-85a/4 |
| | ● | ● | | ● | | | |
| | 4pole | 4pole | | 4pole | | | |
| | 690V | 690V | | 690V | | | |
| | 690V | 690V | | 1000V | | | |
| | 50/60Hz | 50/60Hz | | 50/60Hz | | | |
| | 6kV | 6kV | | 8kV | | | |
| | 1800 operations | 1800 operations per hour | | 1800 operations per hour | | | |
| | 15 mil. operations | 15 mil. operations | | 12 mil. operations | | | |
| | 1 mil. operations | 1 mil. operations | | 1 mil. operations | | | |
| | 40 | 50 | 60 | 80 | 100 | 110 | 135 |
| | 15 | 18 | 22 | 30 | 37 | 41 | 51 |
| | 40 | 50 | 60 | 80 | 100 | 110 | 135 |
| | 27 | 35 | 42 | 56 | 70 | 76 | 95 |
| | 40 | 50 | 60 | 80 | 100 | 110 | 135 |
| | 35 | 43 | 52 | 70 | 88 | 97 | 120 |
| | 40 | 50 | 60 | 80 | 100 | 110 | 135 |
| | 44 | 55 | 66 | 88 | 110 | 120 | 150 |
| | 40 | 50 | 60 | 80 | 100 | 110 | 135 |
| | 32 | 45 | 50 | 70 | 80 | 90 | 100 |
| | 2 | 2 | 3 | 3 | 5 | 5 | 7.5 |
| | 3 | 5 | 5 | 7.5 | 10 | 15 | 15 |
| | 7.5 | 7.5 | 10 | 10 | 15 | 20 | 25 |
| | 7.5 | 10 | 10 | 15 | 20 | 25 | 30 |
| | 10 | 20 | 25 | 30 | 40 | 50 | 50 |
| | 15 | 20 | 25 | 30 | 40 | 50 | 50 |
| | 0.4 | 0.59 | | 1.2 | | | |
| | 47.2×80×86.8 | 59×83.5×94.6 | | 91×123.5×117.8 | | | |
| | 0.5 | 0.7 | | 1.29 | | | |
| | 47.2×80×113.2 | 59×83.5×121 | | 91×123.5×117.8 | | | |
| | - | - | | - | | | |
| | AU-1 | AU-1 | | AU-1 | | | |
| | UA-2, UA-4 | UA-2, UA-4 | | UA-2, UA-4 | | | |

Table of specifications



MC type Magnetic Contactors (4pole)

| Frame size | | | | 225AF | | | | | |
|--|----------------------|----------|-------------|--------------------------|-------------|-----------|-----------|-----------|--|
| Type | | | | MC-100a/4 | MC-130a/4 | MC-150a/4 | MC-185a/4 | MC-225a/4 | |
| | Screw clamp terminal | | | ● | | | | | |
| Number of poles | | | | 4pole | | | | | |
| Rated operational voltage (Ue) | | | | 690V | | | | | |
| Rated insulation voltage (Ui) | | | | 1000V | | | | | |
| Rated frequency | | | | 50/60Hz | | | | | |
| Rated impulse withstand voltage, Uimp | | | | 8kV | | | | | |
| Maximum operating rate in operating cycles per hour(AC1) | | | | 1200 operations per hour | | | | | |
| Durability | Mechanical | | | 5 mil. operations | | | | | |
| | Electrical | | | 0.8 mil. operations | | | | | |
| Current and power | Thermal current | [A] | | 200 | 250 | 275 | 300 | 350 | |
| | | [kW] | | 57 | 60 | 76 | 87 | 100 | |
| | AC-1 | 200/240V | [A] | 200 | 250 | 275 | 300 | 350 | |
| | | 380/400V | [kW] | 106 | 110 | 142 | 165 | 185 | |
| | 500/550V | [A] | 200 | 250 | 275 | 300 | 350 | | |
| | | [kW] | 132 | 137 | 180 | 205 | 230 | | |
| | 690V | [A] | 200 | 250 | 275 | 300 | 350 | | |
| | | [kW] | 165 | 170 | 225 | 255 | 290 | | |
| UL rating (50/60Hz) | Continuous current | [A] | 200 | 250 | 275 | 300 | 350 | | |
| | Single | 110~120V | [HP] | 7.5 | 10 | 15 | 15 | 15 | |
| | Phase | 220~240V | [HP] | 15 | 20 | 25 | 30 | 40 | |
| | Three | 200~208V | [HP] | 30 | 40 | 40 | 60 | 60 | |
| | Phase | 220~240V | [HP] | 30 | 40 | 50 | 60 | 75 | |
| | | 440~480V | [HP] | 60 | 75 | 100 | 125 | 150 | |
| | | 550~600V | [HP] | 60 | 75 | 100 | 125 | 150 | |
| | | | | | | | | | |
| Size and weight | AC | Weight | [kg] | 5.6 | | | | | |
| | | Control | Size(W×H×D) | [mm] | 175×203×185 | | | | |
| | DC | Weight | [kg] | 5.6 | | | | | |
| | | Control | Size(W×H×D) | [mm] | 175×203×185 | | | | |
| Auxiliary(Standard) | | | | 2NO2NC | | | | | |
| Auxiliary | Side mount | | | AU-100, AU-100E | | | | | |
| | Front mount | | | - | | | | | |

* - FLA=722A, LRA=5618A

** - FLA=566A, LRA=4495A



| 400AF | | | 800AF | | |
|--------------------------|-----------|-----------|--------------------------|-----------|-----------|
| MC-265a/4 | MC-330a/4 | MC-400a/4 | MC-500a/4 | MC-630a/4 | MC-800a/4 |
| ● | | | ● | | |
| 4pole | | | 4pole | | |
| 690V | | | 690V | | |
| 1000V | | | 1000V | | |
| 50/60Hz | | | 50/60Hz | | |
| 8kV | | | 8kV | | |
| 1200 operations per hour | | | 1200 operations per hour | | |
| 2.5 mil. operations | | | 2.5 mil. operations | | |
| 0.5 mil. operations | | | 0.5 mil. operations | | |
| 400 | 500 | 520 | 700 | 900 | 1050 |
| 115 | 135 | 160 | 245 | 255 | 310 |
| 400 | 500 | 520 | 700 | 900 | 1050 |
| 215 | 250 | 300 | 450 | 470 | 570 |
| 400 | 500 | 520 | 700 | 900 | 1050 |
| 265 | 315 | 375 | 560 | 590 | 710 |
| 400 | 500 | 520 | 700 | 900 | 1050 |
| 335 | 390 | 470 | 710 | 740 | 900 |
| 400 | 500 | 520 | 700 | 900 | 1050 |
| 400 | 500 | 520 | 700 | 900 | 1050 |
| - | - | - | - | - | - |
| - | - | - | - | - | - |
| 75 | 100 | 125 | 150 | 200 | 200 |
| 100 | 100 | 150 | 200 | 250 | 300 |
| 200 | 200 | 300 | 400 | 500 | 600* |
| 200 | 200 | 300 | 400 | 500 | 600** |
| 9.9 206×243×205 | | | 26.3 346×310×244 | | |
| 9.9 206×243×205 | | | 26.3 346×310×244 | | |
| 2NO2NC | | | 2NO2NC | | |
| AU-100, AU-100E | | | AU-100, AU-100E | | |
| - | | | - | | |

Table of specifications

Renewable Magnetic Contactor

- Eco-friendly contact material applied (Cd free)
- Type 2 coordination data with MCCB or ACB



| Frame size | | | 1260AF | | | |
|---|------------------------|-----------------|-----------------------------------|-----------------|---------------|---|
| Type | | | MCI-900 | MCI-1050 | MCI-1260 | |
| | Screws clamp terminals | | | ● | | |
| Number of poles | [pole] | | | 3 | | |
| Rated operational voltage(Ue) | [Vac] | | | 1000 | | |
| Rated insulation voltage(Ui) | [Vac] | | | 1000 | | |
| Rated frequency | [Hz] | | | 50/60 | | |
| Rated impulse withstand voltage(Uimp) | [kV] | | | 8 | | |
| Mechanical operating cycle | [cycles/hour] | | 600 | 600 | 300 | |
| Electrical operating cycle | [cycles/hour] | | 600 | 600 | 300 | |
| Durability | Mechanical | [million] | 1 | 1 | 0.5 | |
| | Electrical(AC-1@690V) | [million] | 0.26 | 0.26 | 0.15 | |
| | Electrical(AC-1@400V) | [million] | 0.5 | 0.5 | 0.2 | |
| Current and Power (IEC) | AC-1 1000V 55/60/70°C | [A] | 900/850/700 | 1050/875/720 | 1260/1060/900 | |
| | Thermal current | [A] | 900 | 1050 | 1260 | |
| | Heat dissipation | [W] | 100 | 170 | 170 | |
| Rated Short-time withstand current(Icw) (IEC 60947) | 1s | [A] | 7000 | 7500 | 8000 | |
| | 10s | [A] | 6400 | 7000 | 7200 | |
| | 1min | [A] | 3500 | 3800 | 4000 | |
| | 10min | [A] | 1550 | 1550 | 2300 | |
| max. breaking capacity(Icd) | 400V | [A] | 6000 | 7500 | 7500 | |
| | 690V | [A] | 5000 | 7000 | 7000 | |
| | 1000V | [A] | 2000 | 2500 | 2500 | |
| Type-2 Coordination (with MCCB or ACB) | [kA] | | 42kA (Break time: less than 20ms) | | | |
| Current and HP (UL) | Thermal current | [A] | 900 | 1050 | 1260 | |
| | Single phase | 110~120V | [HP] | - | - | - |
| | | 220~240V | [HP] | - | - | - |
| | Three phase | 200~208V | [HP] | 200 | 200 | - |
| | | 220~240V | [HP] | 250 | 300 | - |
| | | 440~480V | [HP] | 500 | 600 | - |
| 550~600V | | [HP] | 500 | 600 | - | |
| Weight | [kg] | 22.2 | 22.2 | 25 | | |
| Size(W×H×D) mm] | | 285 x 310 x 246 | 285 x 310 x 246 | 285 x 352 x 246 | | |
| Auxiliary(Standard) | | | 2a2b | | | |
| Auxiliary | Side mount | | AU-100, AU-100E (max.4a4b) | | | |
| | Front mount | | - | | | |



| 2650AF | | |
|-----------------------------------|-----------------|-----------------|
| MCI-1700 | MCI-2100 | MCI-2650 |
| | ● | |
| | 3 | |
| | 1000 | |
| | 1000 | |
| | 50/60 | |
| | 8 | |
| | 300 | |
| 300 | 300 | 120 |
| 0.5 | 0.5 | 0.3 |
| 0.05 | 0.05 | 0.02 |
| 0.05 | 0.05 | 0.05 |
| 1700/1450/1300 | 2100/1750/1500 | 2650/2350/2150 |
| 1700 | 2100 | 2650 |
| 220 | 350 | 350 |
| | 12000 | |
| | 10000 | |
| | 5500 | |
| | 3000 | |
| 9000 | 12000 | 12000 |
| 8000 | 8500 | 8500 |
| 3000 | 3150 | 3150 |
| 42kA (Break time: less than 50ms) | | |
| 1700 | 2100 | 2650 |
| - | - | - |
| - | - | - |
| - | - | - |
| - | - | - |
| - | - | - |
| 34.6 | 34.6 | 47 |
| 431 x 380 x 246 | 431 x 380 x 246 | 431 x 392 x 246 |
| 2a2b | | |
| AU-100, AU-100E (max.4a4b) | | |
| - | | |

Type numbering system

Contactors

| | | | | | | | |
|----------------------|---|----------------|---|---------------------|------------------|--------------|--------------------------|
| MC-6a | / | R | / | 220V | 60Hz | SCREW | 1a1b |
| Rated current | | Version | | Coil voltage | Frequency | | Auxiliary contact |
| 6a 6A | | - Standard | | AC 220V | 60Hz | None | None |
| ⋮ | | R Reversing | | ⋮ | 50Hz | Screw | 1a1b |
| 2650a 2650A | | 4 4pole | | DC 24V | 50/60HZ | LUG | 2a2b |
| 9b 9A | | | | | | | 1a |
| ⋮ | | | | | | | 1b |
| 22b 22A | | | | | | | |

Note) See page 22, 23 for details.

Renewable contactors

| | | | | |
|----------------------|---|---------------------|------------------|--------------------------|
| MCi-900 | / | AC 300V | 50/60Hz | 2a2b |
| Rated Current | | Coil Voltage | Frequency | Auxiliary contact |
| 900 900A | | AC 300V | 50/60Hz | 2a2b |
| ⋮ | | ⋮ | | |
| 2650 2650A | | AC 100~240V | | |
| | | DC 100~220V | | |

Starters

| | | | | | | | | | |
|----------------------|---|--------------------------|--------------------------------|---|---------------------|------------------|--------------------------|---|------------------------------|
| MS-6a | / | R | 2H | / | 220V | 60Hz | 1N01NC | / | 0.1 |
| Rated current | | Contactor version | Relay version | | Coil voltage | Frequency | Auxiliary contact | | Relay setting current |
| 6a 6A | | - Standard | 2H Non-differential (2-heater) | | AC 220V | 60Hz | 無 | | 0.1 0.1A |
| ⋮ | | R Reversing | 3H Non-differential (3-heater) | | ⋮ | 50Hz | 1a1b | | ⋮ |
| 800a 800A | | | 3K Differential | | DC 24V | | 2a2b | | 800 800A |
| 9b 9A | | | 3D Class 20 | | | | 1a | | |
| ⋮ | | | | | | | 1b | | |
| 22b 22A | | | | | | | | | |

Note) See page 22, 23 for details.

Thermal Overload Relay

| | | | |
|----------------------|---|--------------------------------|------------------------------|
| MT-12 | / | 2H | 0.1 |
| Rated current | | Relay version | Relay setting current |
| 12 12AF | | 2H Non-differential (2-heater) | 0.1 0.1A |
| 32 32AF | | ⋮ | ⋮ |
| 63 63AF | | 3H Non-differential (3-heater) | 800 800A |
| 95 95AF | | 3K Differential | |
| ⋮ | | 3D Class 20 | |
| 800 800AF | | | |

Contactor relays

| | | |
|-----------|---|--------------|
| MR | / | 4 |
| | | Poles |
| | | 4 4 Pole |
| | | 6 6 Pole |
| | | 8 8 Pole |

Optional accessories

Auxiliary contact unit

| UA1 | |
|---------------------------|-----------------|
| Version | |
| UA-1 AU-100 AU-100E | Side mount |
| UA-2 | Front mount(2P) |
| UA-4 | Front mount(4P) |

| 11 | |
|---------------------|---------|
| Contact composition | |
| 11 | 1NO+1NC |
| 20 | 2NO |
| 02 | 2NC |
| 40 | 4NO |
| 31 | 3NO+1NC |
| 22 | 2NO+2NC |
| 13 | 1NO+3NC |
| 04 | 4NC |

Note) UA-2: 2NO, 1NO1NC, 2NC
 UA-4: 4NO, 3NO1NC, 4NC,
 2NO2NC, 1NO3NC,

Surge absorber

| US11 | | |
|-------------------------|-------------|----------------|
| Composition and voltage | | |
| 1 | Varistor+RC | AC 24~48V |
| 2 | Varistor+RC | AC 100~125V |
| 3 | Varistor+RC | AC 200~240V |
| 4 | Varistor+RC | DC 24~48V |
| 5 | Varistor+RC | DC 100~125V |
| 6 | Varistor+RC | DC 200~220V |
| 11 | Varistor | AC/DC 24~48V |
| 12 | Varistor | AC/DC 100~125V |
| 13 | Varistor | AC/DC 200~240V |
| 14 | Varistor | AC/DC 380~440V |
| 22 | RC | AC 100~125V |

Note) See page 82 for details.

| Interlock unit | Wire kit for interlocking | Separate mounting unit (For relay) | Remote reset unit (For relay) |
|----------------------------|---------------------------|------------------------------------|-------------------------------|
| UR02 | UW32 | UZ32 | UM |
| Contact composition | Rated current | Rated current | Cable length |
| 02 2NC | 18 18AF | 12 12AF | 4R 400 |
| 00 None | 22 22AF | 32 32AF | 5R 500 |
| | 32 40AF | 63 63AF | 6R 600 |
| | 63 65AF | 95 95AF | |
| | 95 100AF | 150 150AF | |





















Environment



| | |
|---|--|
| Standards | IEC/EN 60947-1, IEC/EN 60947-4-1, UL508, K60947 |
| Certifications | CE, UL, CCC |
| Rated insulation voltage (Ui) | 1000V (6A-22A: 690V, 32A-800A: 1000V) |
| Rated impulse withstand voltage (Uimp) | 8kV (6A-22A: 6kV, 32A-800A: 8kV) |
| Degree of protection | IP20 (Conforming to IEC60529) |
| Ambient air temperature | <p>Storage: -30°C ~ +65°C (MCI : -40 ~ +80°C)</p> <p>Operation: -5°C ~ +55°C (AC Type) -5°C ~ +40°C (MT, DC Type) -25°C ~ +60°C (MT refer to Graph) -25°C ~ +55°C (MCI)</p> |
| Operating altitude | 3000m (8900ft) |
| Operating positions | |
| Shock resistance (1/2 sine wave =11ms) | Opened: 8G(MC-2650a / MCI-2650 : 5G) Closed: 10G(MC-2650a / MCI-2650 : 5G) |
| Vibration resistance (Conforming to IEC68-2-6) (5...300 Hz) | Opened: 2G(MC-2650a / MCI-2650 : 1G) Closed: 4G(MC-2650a / MCI-2650 : 1G) |
| Flame resistance | Conforming to UL 94: V0 Conforming to IEC 695-2-1: 960°C |

Connections

Metasol MS

| Frame | Wire type | Main terminal size |  |  |  |  |  |  |  | Torque | | |
|-----------------------------------|---|--------------------|---|---|---|---|---|---|---|---------|------|----------|
| | | | (AWG / mm ²) | | | | | | mm(max) | [lb-in] | [Nm] | [kgf-cm] |
| MC-6a/9a |  | M3.5 | 18-10/1-4 | | 18-10 / 1-4 | | 18-10 / 1-4 | | 8.3 | 10 | 1.13 | 12 |
| MC-12a | | | 16-10/1.5-4 | | 16-10 / 1.5-4 | | 16-10 / 1.5-4 | | | | | |
| MC-18a | | | 16-10/1.5-6 | | 16-10 / 1.5-6 | | 16-10 / 1.5-6 | | | | | |
| MC-9b |  | M4 | 18-10/1-4 | | 18-10 / 1-4 | | 18-10 / 1-4 | | 9.6 | 20 | 2.25 | 23 |
| MC-12b | | | 16-10/1.5-6 | | 16-10 / 1.5-6 | | 16-10 / 1.5-6 | | | | | |
| MC-18b | | | 16-10/1.5-6 | | 16-10 / 1.5-6 | | 16-10 / 1.5-6 | | | | | |
| MC-22b | | | 14-8/2.5-10 | | 14-8 / 2.5-10 | | 14-8 / 2.5-10 | | | | | |
| MC-32a |  | M5 | - | | 12-6 / 2.5-16 | | 12-6 / 2.5-16 | | 12.8 | 35 | 4 | 41 |
| MC-40a | | | - | | 12-6 / 2.5-16 | | 12-6 / 2.5-16 | | | | | |
| MC-50a |  | M6 | - | | 10-3 / 4-35 | | 10-3 / 4-35 | | 14 | 35 | 4 | 41 |
| MC-65a | | | - | | 10-2 / 4-35 | | 10-2 / 4-35 | | | | | |
| MC-75a |  | M8 | - | | 10-1 / 6-50 | | 10-1 / 6-50 | | 17 | 45 | 5.1 | 52 |
| MC-85a | | | - | | 10-1/0 / 6-50 | | 10-1/0 / 6-50 | | | | | |
| MC-100a | | | - | | 10-2/0 / 6-70 | | 10-2/0 / 6-70 | | | | | |
| MC-130a |  | M8 | - | | 8-3/0 / 10-95 | | 8-3/0 / 10-95 | | 24 | 80 | 9.1 | 93 |
| MC-150a | | | - | | 8-250kcmil / 10-120 | | 8-250kcmil / 10-120 | | | | | |
| MC-6-150a Aux./Coil |  | M4 | 20-14 / 0.5-2.5 | | 18-12 / 0.75-2.5 | | 18-12 / 0.75-2.5 | | 7.6 | 10 | 1.13 | 12 |
| MC-185a |  | M10 | - | | 3-350kcmil / 35-185 | | 3-350kcmil / 35-185 | | 25 | 130 | 14.7 | 150 |
| MC-225a | | | - | | 3-400kcmil / 35-185 | | 3-400kcmil / 35-185 | | | | | |
| MC-265a |  | M12 | - | | 2-500kcmil / 35-240 | | 2-500kcmil / 35-240 | | 30 | 200 | 22.6 | 230 |
| MC-330a | | | - | | 2-250kcmil x 2 / 35-150 x 2 | | 2-250kcmil x 2 / 35-150 x 2 | | | | | |
| MC-400a | | | - | | 2-350kcmil x 2 / 35-185 x 2 | | 2-350kcmil x 2 / 35-185 x 2 | | | | | |
| MC-500a |  | M16 | - | | 4/0-300kcmil x 3 / 95-240 x 2 | | 4/0-300kcmil x 3 / 95-240 x 2 | | 40 | 500 | 56.5 | 576 |
| MC-630a/MCi-900 | | | - | | 95-60 x 5 x 2 | | 95-60 x 5 x 2 | | | | | |
| MC-800a/MCi-1050 | | | - | | 95-80 x 5 x 2 | | 95-80 x 5 x 2 | | | | | |
| MC-185-800a/MCi-1050 Aux./Coil |  | M4 | 16-10 / 1.25-5.5 | | 16-10 / 1.25-5.5 | | 16-10 / 1.25-5.5 | | 7.6 | 15 | 1.75 | 18 |
| MC-1260a/MCi-1260 |  | M12 | - | | 50mm×10mm×2ea | | - | | - | 200 | 22.6 | 230 |
| MC-1400a |  | M12 | - | | 100mm×5mm×2ea 100mm×5mm×3ea 100mm×5mm×4ea 100mm×10mm×3ea | | - | | - | 200 | 22.6 | 230 |
| MC-1700a/MCi-1700 | | | - | | | | | | | | | |
| MC-2100a/MCi-2100 | | | - | | | | | | | | | |
| MC-2650a/MCi-2650 | | | - | | | | | | | | | |

Control coil characteristics (3pole)



| Frame size | | | 18AF | 22AF | 40AF | 65AF | 100AF | 150AF(A) | |
|--------------------------|---------|---------|---|---|-------------------|-----------|-----------|---|-------------|
| Type | | | MC-6a | MC-9b | MC-32a | MC-50a | MC-75a | MC-130a | |
| | | | MC-9a | MC-12b | MC-40a | MC-65a | MC-85a | MC-150a | |
| | | | MC-12a | MC-18b | | MD-30a | MC-100a | | |
| | | | MC-18a | MC-22b | | | MD-60a | | |
| | | | MR-4, 6, 8 | | | | MD-100a | | |
| AC coil | | | | | | | | | |
| Control voltage | [Uc] | | | | | | | 48, 110~120, 220~240, 300, 380~440, 500V | |
| | 50Hz | [V] | 24, 32, 36, 42, 48, 80, 100, 110, 120, 220, 230, 240, 380, 400, 415, 440, 500, 550V | | | | | | |
| | 60Hz | [V] | 24, 48, 110, 120, 200, 208, 220, 230, 240, 277, 380, 440, 480, 600V | | | | | | |
| Voltage limit | [Uc] | | 85 ~110% | | | | | | |
| Coil consumption at 20°C | | | | | | | | | |
| AC 220V | Inrush | [VA] | 70 | 70 | 90 | 110 | 240 | 110 | |
| 60Hz | Holding | [VA] | 9 | 9 | 9 | 13 | 17 | 18 | |
| Heat dissipation | | | [W] | 2.3 | 2.3 | 2.7 | 2.8 | 5.4 | 2.7 |
| Operating time | | | | | | | | | |
| | | Closing | [ms] | 15 ... 30 | 15 ... 30 | 15 ... 30 | 15 ... 30 | 15 ... 30 | 20 ... 40 |
| | | Opening | [ms] | 4 ... 19 | 4 ... 19 | 4 ... 19 | 4 ... 19 | 10 ... 30 | 50 ... 7 |
| DC coil | | | | | | | | | |
| Control voltage | | | [Uc] | 12, 20, 24, 30, 48, 60, 80, 100, 110, 125, 200, 220, 250V | | | | 24, 48 | |
| Voltage limit | | | [Uc] | 85~110% | | | | | |
| Coil consumption at 20°C | | | | | | | | | |
| DC 110V | Note 4) | Inrush | [W] | 6 | 6 | 9 | 9 | 18 | 280 Note 3) |
| | | Holding | [W] | 6 | 6 | 9 | 9 | 18 | 7.5 |
| Time constant (L/R) | | | [ms] | 28 | 28 | 28 | 65 | 75 | |
| Operating time | | | | | | | | | |
| | | Closing | [ms] | 40 ... 70 Note 2) | 40 ... 70 Note 2) | 50 ... 65 | 50 ... 65 | 100 ... 120 | 70 ... 80 |
| | | Opening | [ms] | 4 ... 19 | 4 ... 19 | 4 ... 19 | 4 ... 19 | 10 ... 25 | 60 ... 70 |

- Note 1. Either semi-electronic coil(A) or electronic coil(B) can be chosen for MC-130a and MC-150a
 2. The operation time may increase up to 80ms when re-supply after the ON state continues.
 3. MC-150AF is based on DC24V
 4. Coil consumptions for the other coil voltages are similar to the above data

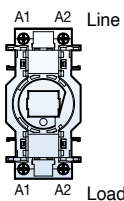

Note) A1(A2) in line side is internally connected to A1(A2) in load side.



| Frame size | 150AF(B) | 225AF | 400AF | 800AF | 1260AF | 2650AF |
|---|----------------------------|--------------------|-------------------------------|--|----------------------|--|
| Type | MC-130a MC-150a | MC-185a MC-225a | MC-265a MC-330a MC-400a | MC-500a MC-630a MC-800a MCi-900 MCi-1050 | MC-1260a MCi-1260 | MC-1400a MC-1700a MC-2100a MC-2650a MCi-1700 MCi-2100 MCi-2650 |
| AC/DC common coil | | | | | | |
| Control voltage [Uc] | | | | | | |
| AC/DC | AC 24 | 24/24 | DC 24 | - | - | - |
| AC/DC | 24~48/24~48 | 48/48 | - | 100/100 | - | - |
| AC/DC | 100~240/100~220 | 100~240/100~220 | 100~240/100~220 | 200/200 | 100~240/100~220 | 100~240/100~220 |
| AC or DC | DC 70~110 | AC 300 | AC 300 | AC 300 | - | - |
| AC or DC | DC 110 | AC 400 | AC 400 | AC 400 | - | - |
| AC or DC | - | AC 500 | AC 500 | AC 500 | - | - |
| Voltage limit [Uc] | 85~110% ^{Note 1)} | | | | | |
| Coil consumption at 20°C ^{Note 2)} | | | | | | |
| AC 220V Inrush [VA] | 320 | 380 | 571 | 1000 | 1500 | 2500 |
| 50/60Hz Holding [VA] | 10 | 11.6 | 14 | 29 | 24 | 50 |
| Heat dissipation [W] | 4.5 | 4.7 | 5 | 7.8 | 7.8 | 8.7 |
| Operating time | | | | | | |
| Closing [ms] | 70 | 70 | 55 | 75 | 75 | 80 |
| Opening [ms] | 70 | 70 | 55 | 75 | 75 | 70 |

Note) 1. Voltage limit for DC 24V coil is 75~110%.

2. Operating time for DC 24V coil is 90ms.

3. Either semi-electronic coil(A) or electronic coil(B) can be chosen for MC-130a and MC-150a

4. Please check the details page for each AF range

Control coil characteristics (4pole)



| Frame size | | | 18AF | 22AF | 40AF | 85AF |
|--------------------------|---------|------|--|---|------------------------|---|
| Type | | | MC-6a/4P MC-9a/4P MC-12a/4P MC-18a/4P | MC-22a/4P | MC-32a/4P MC-40a/4P | MC-50a/4P MC-65a/4P MC-75a/4P MC-85a/4P |
| AC coil | | | | | | |
| Control voltage | [Uc] | | | | | |
| | 50Hz | [V] | 24, 32, 42, 48, 80, 100, 110, 220, 230, 240, 380, 400, 500, 550 | 24, 32, 42, 48, 65, 80, 100, 110, 220, 230, 240, 380, 400, 415, 500, 550, 240(wide) | | 24, 48, 100, 110, 200, 220, 230, 240, 380, 400, 415, 440, 500, 550, 240(wide) |
| | 60Hz | [V] | 24, 48, 100, 110, 120, 200, 208, 220, 230, 240, 277, 380, 480, 600 | 24, 48, 110, 120, 208, 220, 240, 277, 380, 440, 480, 600 | | 24, 48, 110, 120, 208, 220, 230, 240, 277, 380, 440, 480, 600 |
| | 50/60Hz | [V] | 24, 48, 100, 110, 120, 200, 220, 230, 20, 380, 415, 440, 500, 550 | 24, 48, 100, 110, 120, 200, 220, 230, 240, 380, 415, 440, 500, 550 | | 24, 48, 110, 120, 220, 230, 240, 380, 415, 440, 500, 550 |
| Voltage limit | | | 85~110% | | | |
| Coil consumption at 20°C | | | | | | |
| AC 220V | Inrush | [VA] | 70 | 95 | 95 | 220 |
| 60Hz | Holding | [VA] | 9 | 9 | 9 | 17 |
| Heat dissipation | | [W] | 2.3 | 2 | 2 | 5 |
| Operating time | Closing | [ms] | 15...30 | 10~17 | 10~17 | 16~25 |
| | Opening | [ms] | 4...9 | 6~9 | 6~9 | 8~15 |
| DC coil | | | | | | |
| Control voltage | [Uc] | | 12, 20, 24, 48, 60, 80, 100, 110, 125, 200, 220, 250 | | | |
| Voltage limit | | | 85~110% | | | |
| Coil consumption at 20°C | | | | | | |
| DC 100V | Inrush | [W] | 6 | 9 | 9 | 460 |
| (18AF: DC110V) | Holding | [W] | 6 | 9 | 9 | 6 |
| Time constant (L/R) | | [ms] | 28 | 50 | 50 | - |
| Operating time | Closing | [ms] | 40...60 | 45~55 | 45~55 | 20~30 |
| | Opening | [ms] | 4...19 | 8~15 | 8~15 | 13~20 |



| Frame size | | | 225AF | 400AF | 800AF |
|---|---------|------|--|--|--|
| Type | | | MC-100a/4P MC-130a/4P MC-150a/4P MC-185a/4P MC-225a/4P | MC-265a/4P MC-330a/4P MC-400a/4P | MC-500a/4P MC-630a/4P MC-800a/4P |
| AC/DC common coil | | | | | |
| Control voltage | [Uc] | | | | |
| | [AC/DC] | | 24/24 | 24(DC Only) | - |
| | [AC/DC] | | 48/48 | - | 100/100 |
| | [AC/DC] | | 100~240/100~220 | 100~240/100~220 | 200/200 |
| | [AC] | | 300 | 300 | 300 |
| | [AC] | | 400 | 400 | 400 |
| | [AC] | | 500 | 500 | 500 |
| Voltage limit | | | 85~110% <i>Note 1)</i> | | |
| Coil consumption at 20°C <i>Note 2)</i> | | | | | |
| AC 220V 50/60Hz | Inrush | [VA] | 380 | 571 | 1000 |
| | Holding | [VA] | 11.6 | 14 | 29 |
| Heat dissipation | | [W] | 4.7 | 5 | 7.8 |
| Operating time | Closing | [ms] | 70 | 55 | 75 |
| | Opening | [ms] | 70 | 55 | 75 |

Note 1) 1. Voltage limit for DC 24V coil is 75~110%.

2. Operating time for DC 24V coil is 90ms.

Marking

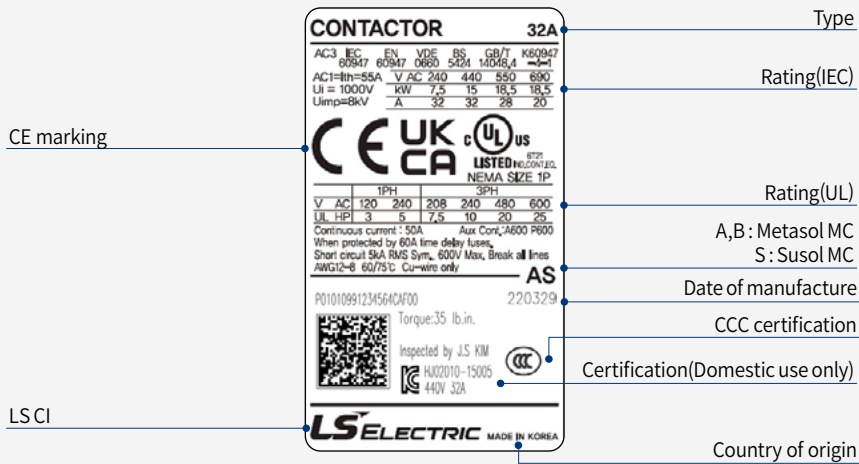
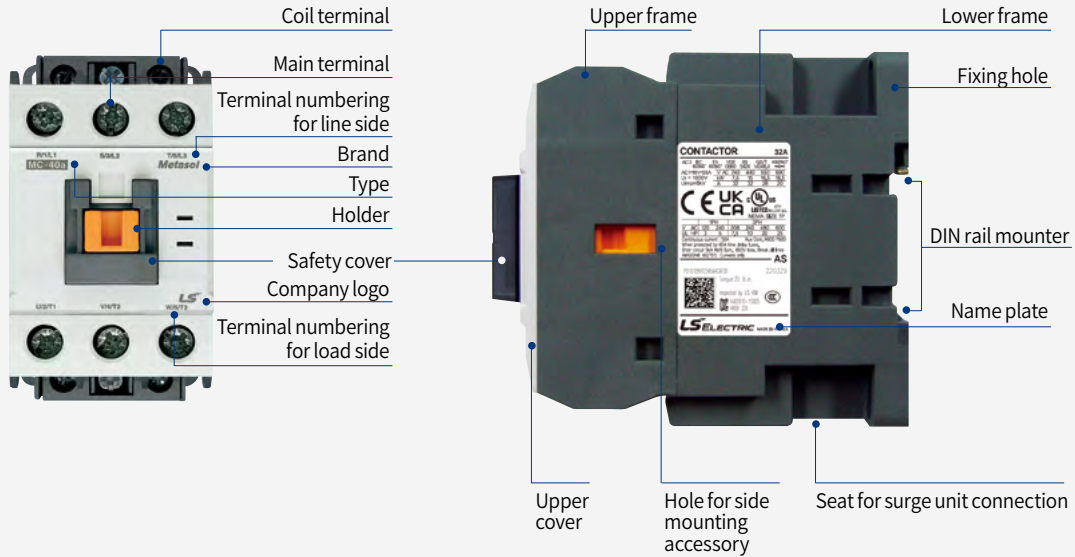

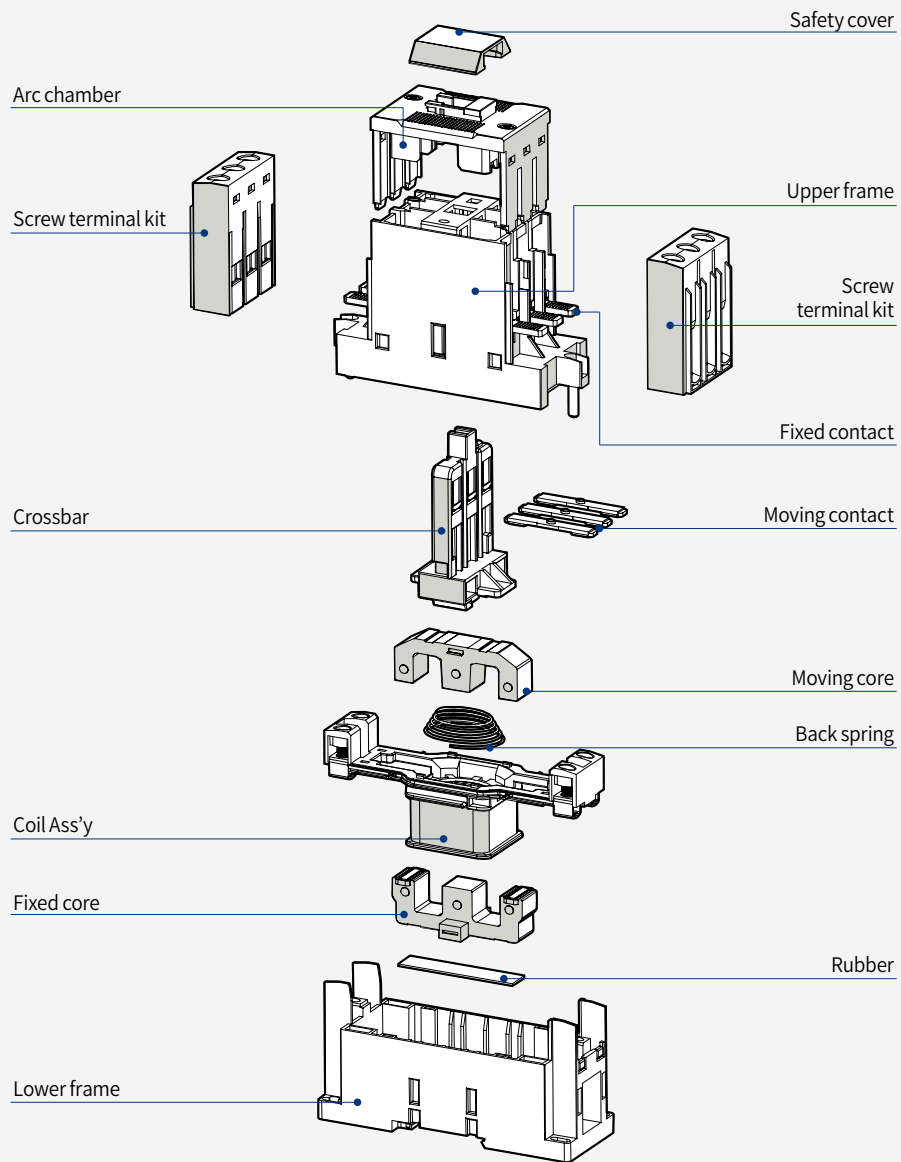

Contactors

Description 18AF

- 3-pole(NO) main contact
- Finger proof design
- DIN rail(35mm) or screw mountable
- AC or DC control in different physical size
- Front/side mountable accessories available
- Direct mountable overload relay available rating
- 1NO or 1NC Auxiliary contact built-in as standard.
- Degree of protection: IP20

Rating



MC-18a

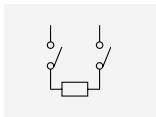

2pole for DC contact

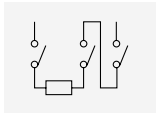

3pole for DC contact

| Contactor type | | | MC-6a | | MC-9a | | MC-12a | | MC-18a | | |
|--|---------------------------|---------------------|----------------------|-------|-------|-------|--------|--------|--------|--------|----|
| | | | kW | A | kW | A | kW | A | kW | A | |
| AC duty | AC3 | 200/240V | 2.2 | 9 | 2.5 | 11 | 3.5 | 13 | 4.5 | 18 | |
| | | 380/440V | 3 | 7 | 4 | 9 | 5.5 | 12 | 7.5 | 18 | |
| | | 500/550V | 3 | 6 | 4 | 7 | 7.5 | 12 | 7.5 | 13 | |
| | | 690V | 3 | 4 | 4 | 5 | 7.5 | 9 | 7.5 | 9 | |
| | AC4 | 200/240V | 1.5 | 7 | 1.5 | 8 | 2.2 | 11 | 3.7 | 16 | |
| | | 380/440V | 2.2 | 5 | 2.2 | 6 | 4 | 9 | 4 | 11 | |
| | AC1 | | - | 25 | - | 25 | - | 25 | - | 32 | |
| DC1 duty (L/R=1ms) | 2-pole in series | 24V | - | 10 | - | 10 | - | 12 | - | 18 | |
| | | 48V | - | 10 | - | 10 | - | 12 | - | 18 | |
| | | 110V | - | 6 | - | 6 | - | 10 | - | 13 | |
| | 3-pole in series | 24V | - | 10 | - | 10 | - | 12 | - | 18 | |
| | | 48V | - | 10 | - | 10 | - | 12 | - | 18 | |
| | | 110V | - | 8 | - | 8 | - | 12 | - | 18 | |
| | DC3, 5 duty (L/R=15ms) | 2-pole in series | 24V | - | 8 | - | 8 | - | 12 | - | 12 |
| | | | 48V | - | 4 | - | 4 | - | 6 | - | 6 |
| | | | 110V | - | 2.5 | - | 2.5 | - | 4 | - | 4 |
| 3-pole in series | | 24V | - | 8 | - | 8 | - | 12 | - | 12 | |
| | | 48V | - | 6 | - | 6 | - | 10 | - | 10 | |
| | | 110V | - | 4 | - | 4 | - | 8 | - | 8 | |
| Directly mountable overload relay | | | MT-12 | | | | | | | | |
| Conductor size (Solid, stranded) (the max. number of conducts: 2) | | | AWG | 18~10 | | 16~10 | | 16~8 | | 14~8 | |
| | | | mm ² | 1~4 | | 1.5~4 | | 1.5~10 | | 2.5~10 | |
| Conductor type | | | 65/75°C Cu-wire only | | | | | | | | |



Coil voltage

| | | |
|----|------|---|
| AC | 50Hz | 24, 32, 36, 42, 48, 80, 100, 110, 120, 220, 230, 240, 380, 400, 415, 440, 500, 550V |
| | 60Hz | 24, 48, 110, 120, 200, 208, 220, 230, 240, 277, 380, 440, 480, 600V |
| DC | | 12, 20, 24, 30, 48, 60, 80, 100, 110, 125, 200, 220, 250V |

Certification

- CE(IEC)
- UL508
- CCC

* Please be cautious for wiring control power cable, especially “+” (Positive) and “-” (Negative) polarity should be correctly considered.

Accessories

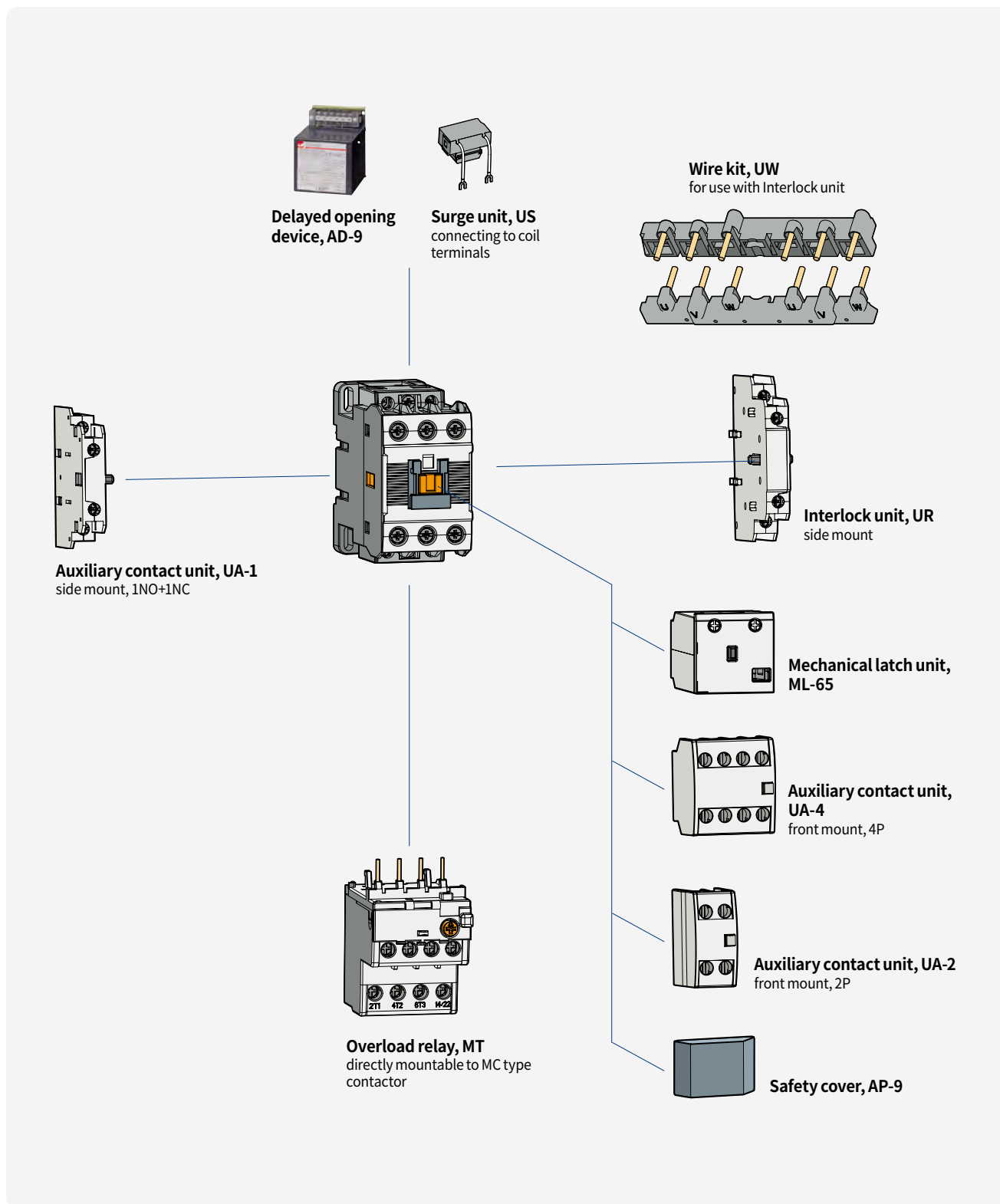

Contactors

Description 22AF

- 3-pole(NO) main contact
- Finger proof design
- DIN rail(35mm) or screw mountable
- AC or DC control in different physical size
- Front/side mountable accessories available
- Direct mountable overload relay available rating
- 1NO1NC Auxiliary contact built-in as standard.
- UA-1 is available on only left side
- Degree of protection: IP20



MC-22b

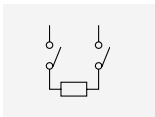

2pole for DC contact

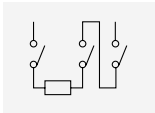

3pole for DC contact

Rating

| Contactor type | | | MC-9b | | MC-12b | | MC-18b | | MC-22b | |
|--|---------------------|-----------------|----------------------|----|--------|----|--------|----|--------|----|
| | | | kW | A | kW | A | kW | A | kW | A |
| AC duty | AC3 | 200/240V | 2.5 | 11 | 3.5 | 13 | 4.5 | 18 | 5.5 | 22 |
| | | 380/440V | 4 | 9 | 5.5 | 12 | 7.5 | 18 | 11 | 22 |
| | | 500/550V | 4 | 7 | 7.5 | 12 | 7.5 | 13 | 15 | 20 |
| | | 690V | 4 | 6 | 7.5 | 9 | 7.5 | 9 | 15 | 18 |
| | AC4 | 200/240V | 1.5 | 8 | 2.2 | 11 | 3.7 | 16 | 3.7 | 18 |
| | | 380/440V | 2.2 | 6 | 4 | 9 | 4 | 11 | 5.5 | 13 |
| DC1 duty (L/R=1ms) | 2-pole in series | 24V | - | 25 | - | 27 | - | 40 | - | 45 |
| | | 48V | - | 10 | - | 12 | - | 18 | - | 20 |
| | | 110V | - | 6 | - | 10 | - | 13 | - | 15 |
| DC3, 5 duty (L/R=15ms) | 2-pole in series | 24V | - | 10 | - | 12 | - | 18 | - | 20 |
| | | 48V | - | 10 | - | 12 | - | 18 | - | 20 |
| | | 110V | - | 8 | - | 12 | - | 18 | - | 20 |
| | 3-pole in series | 24V | - | 10 | - | 12 | - | 18 | - | 20 |
| | | 48V | - | 10 | - | 12 | - | 18 | - | 20 |
| | | 110V | - | 8 | - | 12 | - | 18 | - | 20 |
| Directly mountable overload relay | | | MT-32 | | | | | | | |
| Conductor size (Solid, stranded) (the max. number of conducts: 2) | | AWG | 16~10 | | 16~8 | | 14~8 | | 14~8 | |
| | | mm ² | 1.5~4 | | 1.5~10 | | 2.5~10 | | 2.5~10 | |
| Conductor type | | | 65/75°C Cu-wire only | | | | | | | |



Coil voltage

| | | |
|----|------|---|
| AC | 50Hz | 24, 32, 36, 42, 48, 80, 100, 110, 120, 220, 230, 240, 380, 400, 415, 440, 500, 550V |
| | 60Hz | 24, 48, 110, 120, 200, 208, 220, 230, 240, 277, 380, 440, 480, 600V |
| DC | | 12, 20, 24, 30, 48, 60, 80, 100, 110, 125, 200, 220, 250V |

Certification

- CE(IEC)
- UL508
- CCC

* Please be cautious for wiring control power cable, especially “+” (Positive) and “-” (Negative) polarity should be correctly considered.

Accessories

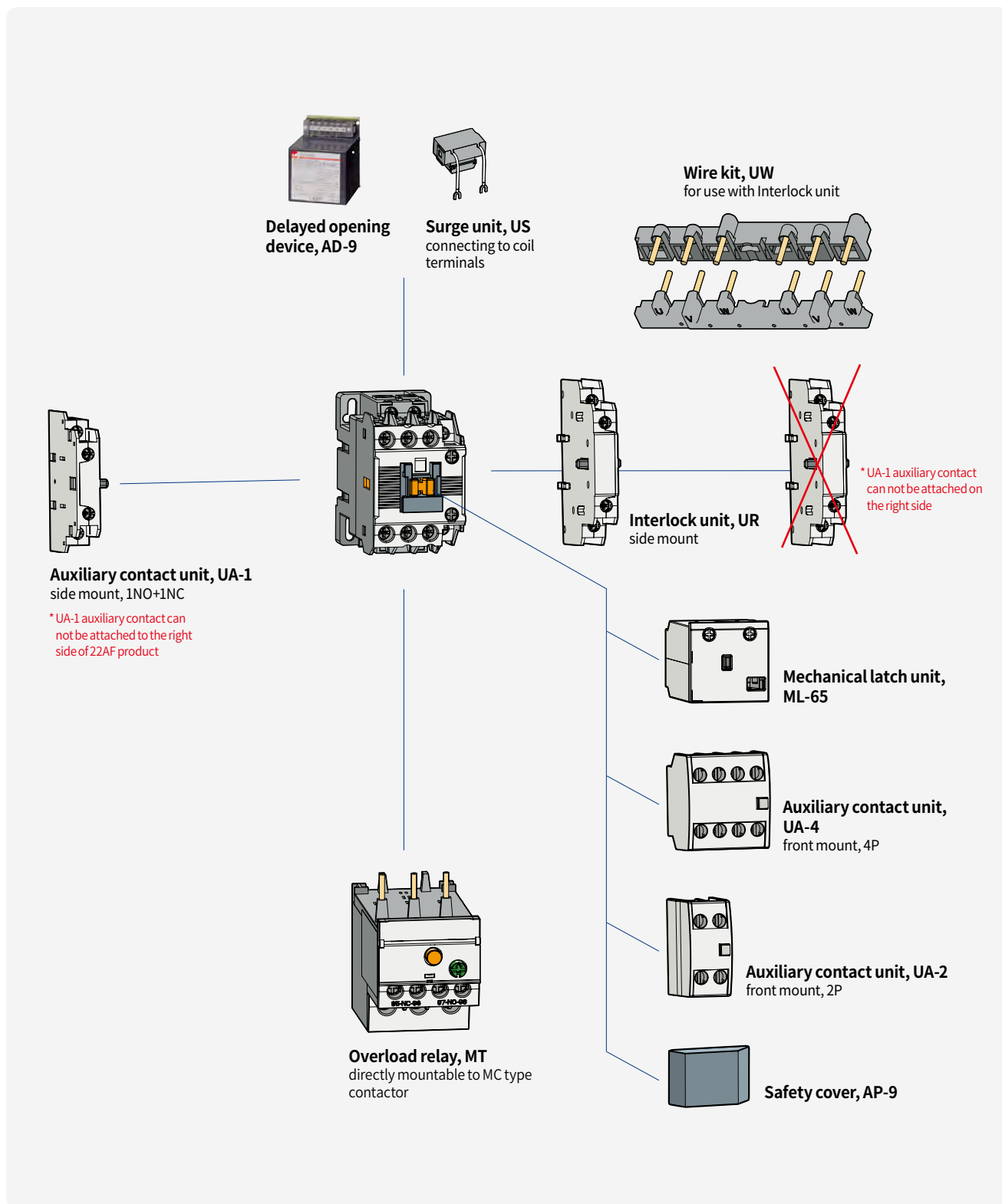

Contactors

Description 40AF

- 3-pole(NO) main contact
- Finger proof design
- DIN rail(35mm) or screw mountable
- AC or DC control in different physical size
- Front/side mountable accessories available
- Direct mountable overload relay available rating
- 2NO2NC Auxiliary contact built-in is possible as standard
- Degree of protection: IP20

Rating



MC-40a

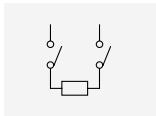

2pole for DC contact

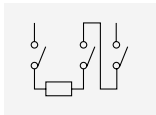

3pole for DC contact

| Contactor type | | | MC-32a | | MC-40a | | | |
|---------------------------|--|-----------------------|----------------------|-------|--------|----|---|----|
| | | | kW | A | kW | A | | |
| AC duty | AC3 | 200/240V | 7.5 | 32 | 11 | 40 | | |
| | | 380/440V | 15 | 32 | 18.5 | 40 | | |
| | | 500/550V | 18.5 | 28 | 22 | 32 | | |
| | | 690V | 18.5 | 20 | 22 | 23 | | |
| | | 1000V | 22 | 17 | 22 | 17 | | |
| | AC4 | 200/240V | 4.5 | 20 | 5.5 | 25 | | |
| | | 380/440V | 7.5 | 17 | 11 | 24 | | |
| | | AC1 | - | 55 | - | 60 | | |
| | | DC1 duty (L/R=1ms) | 2-pole in series | 24V | - | 25 | - | 35 |
| | | | | 48V | - | 25 | - | 35 |
| 110V | - | | | 25 | - | 25 | | |
| 3-pole in series | 24V | | - | 25 | - | 35 | | |
| | 48V | | - | 25 | - | 35 | | |
| | 110V | | - | 25 | - | 35 | | |
| DC3, 5 duty (L/R=15ms) | 2-pole in series | 24V | - | 25 | - | 35 | | |
| | | 48V | - | 20 | - | 20 | | |
| | | 110V | - | 10 | - | 10 | | |
| | 3-pole in series | 24V | - | 25 | - | 35 | | |
| | | 48V | - | 25 | - | 30 | | |
| | | 110V | - | 20 | - | 20 | | |
| | Directly mountable overload relay | | | MT-32 | | | | |
| | Conductor size (Solid, stranded) (the max. number of conducts: 2) | AWG | 12~8 | | 8~6 | | | |
| | | mm ² | 2.5~10 | | 10~16 | | | |
| Conductor type | | | 65/75°C Cu-wire only | | | | | |



Coil voltage

| | | |
|----|------|---|
| AC | 50Hz | 24, 32, 36, 42, 48, 80, 100, 110, 120, 220, 230, 240, 380, 400, 415, 440, 500, 550V |
| | 60Hz | 24, 48, 110, 120, 200, 208, 220, 230, 240, 277, 380, 440, 480, 600V |
| DC | | 12, 20, 24, 48, 60, 80, 100, 110, 125, 200, 220, 250V |

Certification

- CE(IEC)
- UL508
- CCC

Accessories

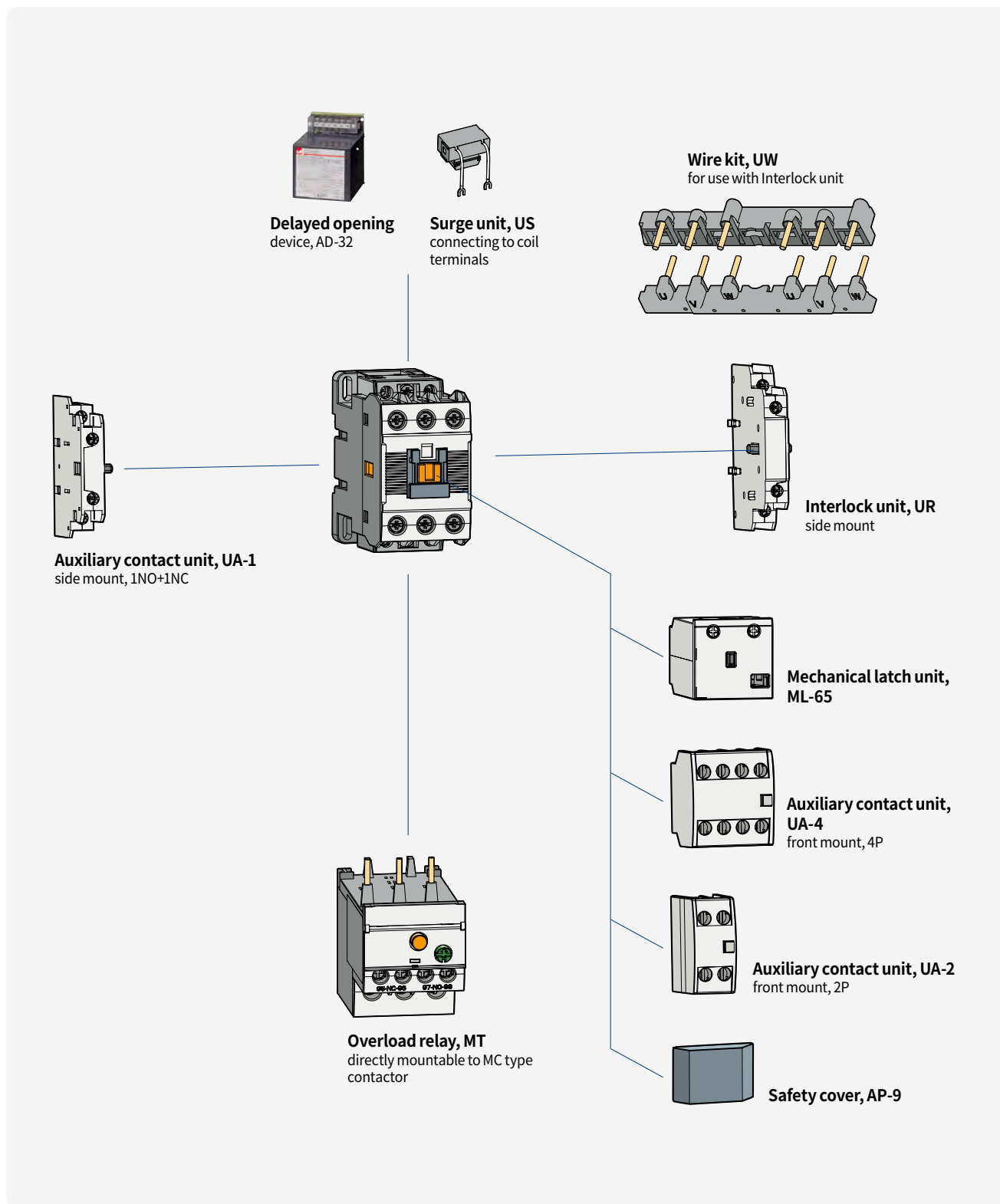

Contactors

Description 65AF

- 3-pole(NO) main contact
- Finger proof design
- DIN rail(35mm) or screw mountable
- Both screw and Box terminal (lug) type are available
- AC or DC control in different physical size
- Front/side mountable accessories available
- Direct mountable overload relay available rating
- 2NO2NC Auxiliary contact built-in is possible as standard
- Degree of protection: IP20

Rating



MC-65a

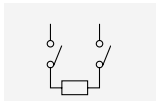

2pole for DC contact

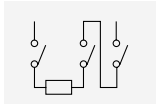

3pole for DC contact

| Contactor type | | | MC-50a | | MC-65a | | |
|--|-----------------------|---------------------|----------------------|-----|--------|-----|----|
| | | | kW | A | kW | A | |
| AC duty | AC3 | 200/240V | 15 | 55 | 18.5 | 65 | |
| | | 380/440V | 22 | 50 | 30 | 65 | |
| | | 500/550V | 30 | 43 | 33 | 60 | |
| | | 690V | 30 | 28 | 33 | 35 | |
| | | 1000V | 30 | 23 | 30 | 23 | |
| | AC4 | 200/240V | 7.5 | 35 | 11 | 50 | |
| | | 380/440V | 15 | 32 | 22 | 47 | |
| | AC1 | | - | 100 | - | 115 | |
| | DC1 duty (L/R=1ms) | 2-pole in series | 24V | - | 50 | - | 50 |
| | | | 48V | - | 40 | - | 40 |
| 110V | | | - | 35 | - | 35 | |
| 3-pole in series | | 24V | - | 50 | - | 65 | |
| | | 48V | - | 50 | - | 65 | |
| | | 110V | - | 50 | - | 65 | |
| DC3, 5 duty (L/R=15ms) | 2-pole in series | 24V | - | 45 | - | 45 | |
| | | 48V | - | 25 | - | 25 | |
| | | 110V | - | 15 | - | 15 | |
| | 3-pole in series | 24V | - | 50 | - | 50 | |
| | | 48V | - | 35 | - | 35 | |
| | | 110V | - | 30 | - | 30 | |
| Directly mountable overload relay | | | MT-63 | | | | |
| Conductor size (Solid, stranded) (the max. number of conducts: 2) | | AWG | 10~4 | | 8~3 | | |
| | | mm ² | 6~25 | | 10~35 | | |
| Conductor type | | | 65/75°C Cu-wire only | | | | |



Coil voltage

| | | |
|----|------|---|
| AC | 50Hz | 24, 32, 36, 42, 48, 80, 100, 110, 120, 220, 230, 240, 380, 400, 415, 440, 500, 550V |
| | 60Hz | 24, 48, 110, 120, 200, 208, 220, 230, 240, 277, 380, 440, 480, 600V |
| DC | | 12, 20, 24, 48, 60, 80, 100, 110, 125, 200, 220, 250V |

Certification

- CE(IEC)
- UL508
- CCC

Accessories

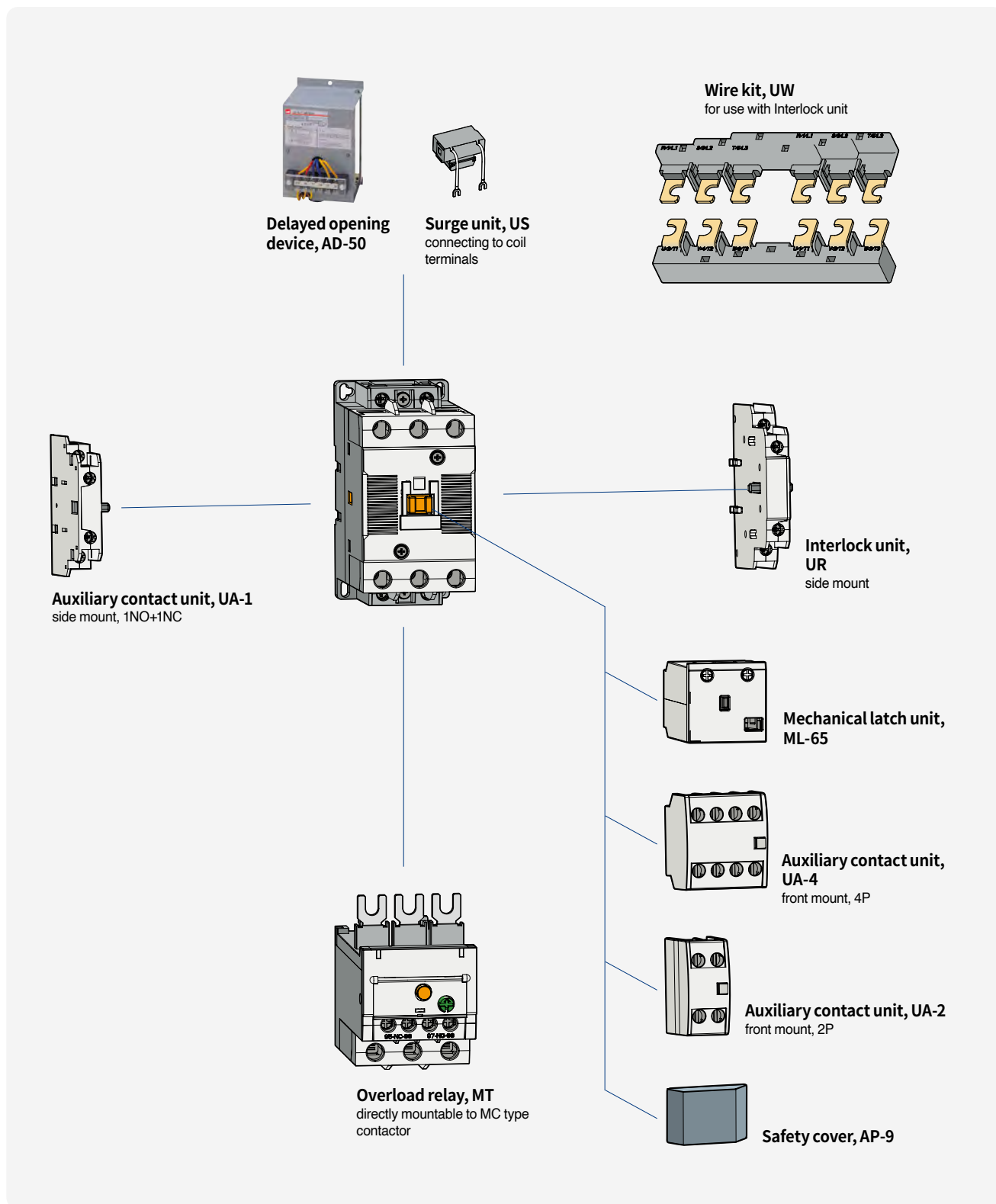

Contactors

Description 100AF

- 3-pole(NO) main contact
- Finger proof design
- DIN rail(35, 70mm) or screw mountable
- Both screw and Box terminal (lug) type are available
- AC or DC control in different physical size
- Front/side mountable accessories available
- Direct mountable overload relay available rating
- 2NO2NC Auxiliary contact built-in is possible as standard
- Degree of protection: IP20

Rating



MC-100a

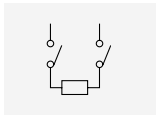

2pole for DC contact

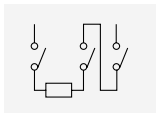

3pole for DC contact

| Contactor type | | | MC-75a | | MC-85a | | MC-100a | | |
|--|-----------------------|---------------------|----------------------|-----|--------|-----|---------|-----|-----|
| | | | kW | A | kW | A | kW | A | |
| AC duty | AC3 | 200/240V | 22 | 75 | 25 | 85 | 30 | 105 | |
| | | 380/440V | 37 | 75 | 45 | 85 | 55 | 105 | |
| | | 500/550V | 37 | 64 | 45 | 75 | 55 | 85 | |
| | | 690V | 37 | 42 | 45 | 45 | 55 | 65 | |
| | | 1000V | 37 | 28 | 37 | 28 | 37 | 28 | |
| | AC4 | 200/240V | 13 | 55 | 15 | 65 | 19 | 80 | |
| | | 380/440V | 25 | 52 | 30 | 62 | 37 | 75 | |
| | AC1 | | - | 125 | - | 135 | - | 160 | |
| | DC1 duty (L/R=1ms) | 2-pole in series | 24V | - | 75 | - | 80 | - | 100 |
| | | | 48V | - | 65 | - | 65 | - | 100 |
| 110V | | | - | 50 | - | 50 | - | 80 | |
| 3-pole in series | | 24V | - | 75 | - | 80 | - | 100 | |
| | | 48V | - | 75 | - | 80 | - | 100 | |
| | | 110V | - | 75 | - | 80 | - | 100 | |
| DC3, 5 duty (L/R=15ms) | 2-pole in series | 24V | - | 65 | - | 65 | - | 100 | |
| | | 48V | - | 40 | - | 40 | - | 60 | |
| | | 110V | - | 20 | - | 20 | - | 40 | |
| | 3-pole in series | 24V | - | 80 | - | 80 | - | 100 | |
| | | 48V | - | 60 | - | 60 | - | 90 | |
| | | 110V | - | 50 | - | 50 | - | 80 | |
| Directly mountable overload relay | | | MT-95 | | | | | | |
| Conductor size (Solid, stranded) (the max. number of conducts: 2) | | AWG | 8-2 | | 8-0 | | 8-00 | | |
| | | mm ² | 10-35 | | 10-50 | | 10-70 | | |
| Conductor type | | | 65/75°C Cu-wire only | | | | | | |



Coil voltage

| | | |
|----|------|---|
| AC | 50Hz | 24, 32, 36, 42, 48, 80, 100, 110, 120, 220, 230, 240, 380, 400, 415, 440, 500, 550V |
| | 60Hz | 24, 48, 110, 120, 200, 208, 220, 230, 240, 277, 380, 440, 480, 600V |
| DC | | 12, 20, 24, 48, 60, 80, 100, 110, 125, 200, 220, 250V |

Certification

- CE(IEC)
- UL508
- CCC

Accessories

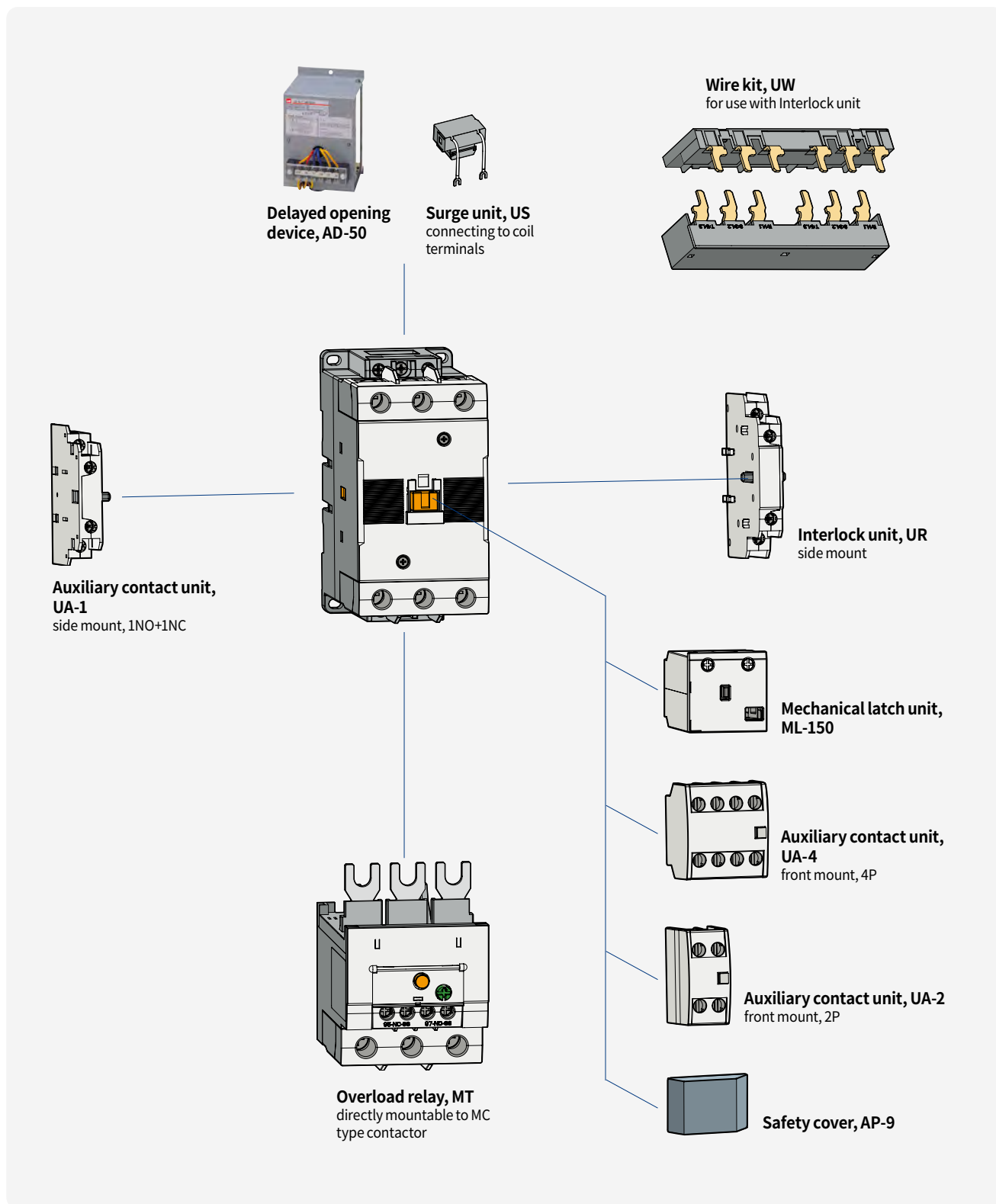

Contactors

Description 150AF

- 3-pole(NO) main contact
- Finger proof design
- DIN rail(70mm) or screw mountable
- Both screw and Box terminal (lug) type are available
- AC or DC control in the same physical size
- Front/side mountable accessories available
- Direct mountable overload relay available
- 2NO2NC Auxiliary contact built-in is possible as standard
- Degree of protection: IP20

Rating



MC-150a

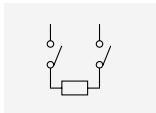

2pole for DC contact

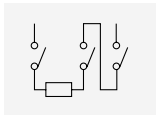

3pole for DC contact

| Contactor type | | | MC-130a | | MC-150a | |
|--|---------------------|----------|----------------------|-----|---------|-----|
| | | | kW | A | kW | A |
| AC duty | AC3 | 200/240V | 37 | 130 | 45 | 150 |
| | | 380/440V | 60 | 130 | 75 | 150 |
| | | 500/550V | 60 | 90 | 70 | 100 |
| | | 690V | 55 | 60 | 55 | 60 |
| | | 1000V | 75 | 50 | 75 | 50 |
| | AC4 | 200/240V | 22 | 93 | 30 | 120 |
| | | 380/440V | 45 | 90 | 55 | 110 |
| | AC1 | | - | 200 | - | 250 |
| DC1 duty (L/R=1ms) | 2-pole in series | 24V | - | 120 | - | 150 |
| | | 48V | - | 100 | - | 120 |
| | | 110V | - | 80 | - | 100 |
| | 3-pole in series | 24V | - | 120 | - | 150 |
| | | 48V | - | 120 | - | 150 |
| | | 110V | - | 100 | - | 150 |
| DC3, 5 duty (L/R=15ms) | 2-pole in series | 24V | - | 120 | - | 150 |
| | | 48V | - | 60 | - | 100 |
| | | 110V | - | 40 | - | 80 |
| | 3-pole in series | 24V | - | 120 | - | 150 |
| | | 48V | - | 90 | - | 130 |
| | | 110V | - | 80 | - | 120 |
| Directly mountable overload relay | | | MT-150 | | | |
| Conductor size (Solid, stranded) (the max. number of conducts: 2) | AWG | | 3~00 | | 3~4/0 | |
| | mm ² | | 35~70 | | 35~95 | |
| Conductor type | | | 65/75°C Cu-wire only | | | |



Coil voltage

| | |
|------------|---|
| AC / DC | 100~240 / 100~220 / 24~48 |
| AC 50/60Hz | 24, 48, 100~240, 110~120, 220~240, 300, 380~440, 500V |
| DC | 24, 48, 70~110, 100~220, 110, 220V |

Certification

- CE(IEC)
- UL508
- CCC

Accessories

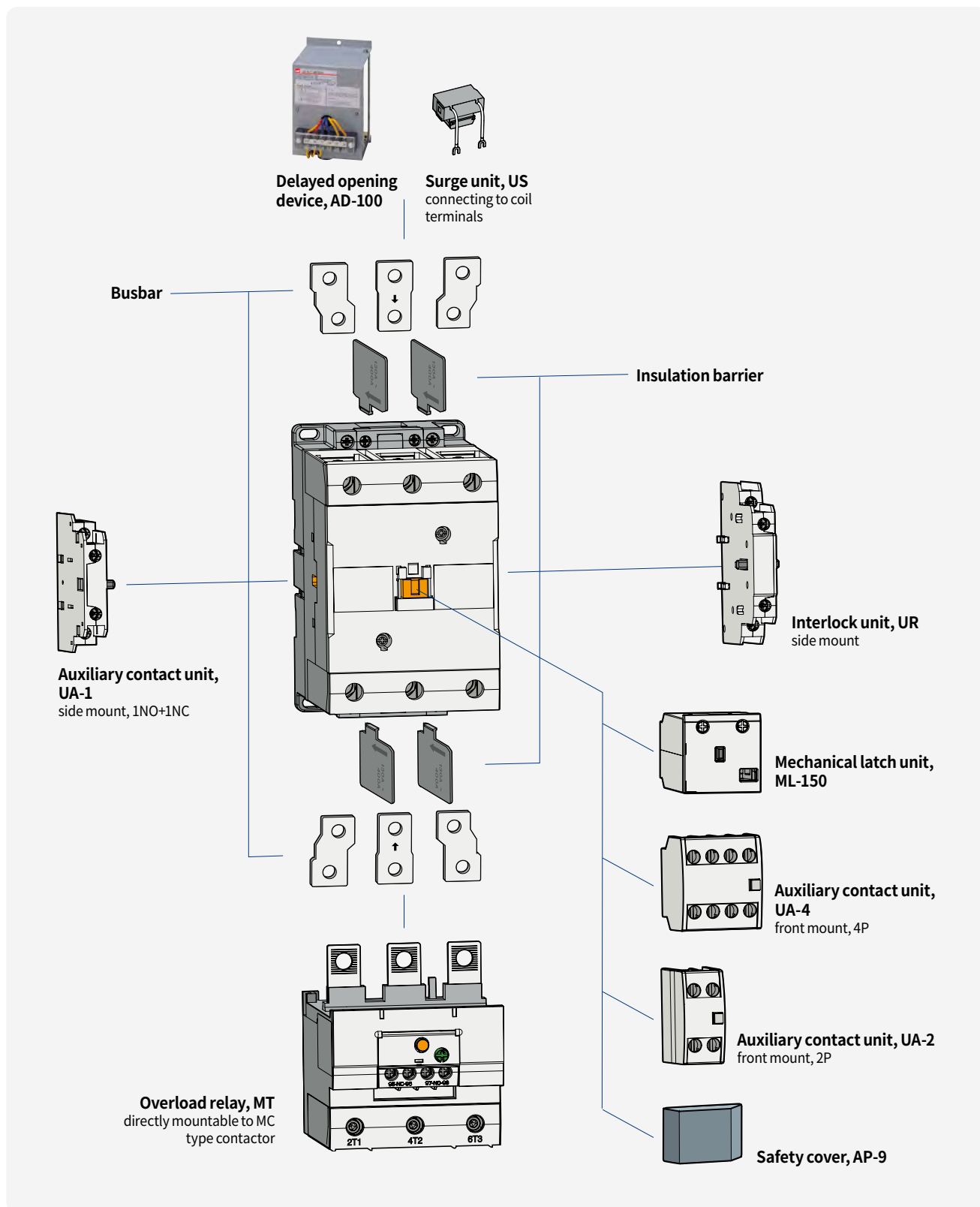

Contactors

Description 225AF

- 3-pole main contact
- AC/DC common use coil built
- Wide coil operation voltage
- Screw mountable
- 2NO+2NC Auxiliary contacts built-in as standard
- Top/side mountable accessories available
- Direct mountable overload relays available
- Degree of protection: IP00



MC-225a

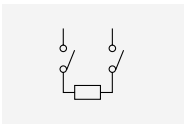

2pole for DC contact

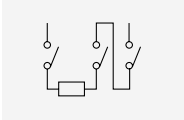

3pole for DC contact

Rating

| Contactor type | | | MC-185a | | MC-225a | |
|--|-----------------------|---------------------|-----------------------|--------|---------|-----|
| | | | kW | A | kW | A |
| AC duty | AC3 | 200/240V | 55 | 185 | 75 | 225 |
| | | 380/440V | 90 | 185 | 132 | 225 |
| | | 500/550V | 110 | 180 | 132 | 200 |
| | | 690V | 110 | 120 | 140 | 150 |
| | | 1000V | 132 | 90 | 132 | 90 |
| | AC4 | 200/240V | 37 | 150 | 45 | 180 |
| | | 380/440V | 75 | 150 | 90 | 180 |
| | AC1 | | - | 300 | - | 350 |
| | DC1 duty (L/R=1ms) | 2-pole in series | 24V | - | 180 | - |
| 48V | | | - | 180 | - | 180 |
| 110V | | | - | 150 | - | 150 |
| 3-pole in series | | 24V | - | 180 | - | 220 |
| | | 48V | - | 180 | - | 220 |
| | | 110V | - | 180 | - | 220 |
| DC3, 5 duty (L/R=15ms) | 2-pole in series | 24V | - | 180 | - | 220 |
| | | 48V | - | 150 | - | 150 |
| | | 110V | - | 120 | - | 120 |
| | 3-pole in series | 24V | - | 180 | - | 220 |
| | | 48V | - | 180 | - | 220 |
| | | 110V | - | 150 | - | 150 |
| Directly mountable overload relay | | | MT-225 | | | |
| Conductor size (Solid, stranded) (The max. number of conducts: 2) | AWG | 1~4/0 | | 0~300 | | |
| | mm ² | 50~95 | | 50~150 | | |
| Conductor type | | | 75°C Cu stranded wire | | | |



Coil voltage, AC/DC common

| Nominal(ordering) voltage | AC 50/60Hz | DC |
|---------------------------|------------|------------|
| 24V | 24 - 25V | 24V |
| 48V | 48 - 50V | 48V |
| 100/200V | 100 - 240V | 100 - 220V |
| 300V | 265 - 347V | - |
| 400V | 380 - 450V | - |
| 500V | 440 - 575V | - |

| Certification |
|---|
| <ul style="list-style-type: none"> • CE(IEC) • UL508 • CCC |

Accessories

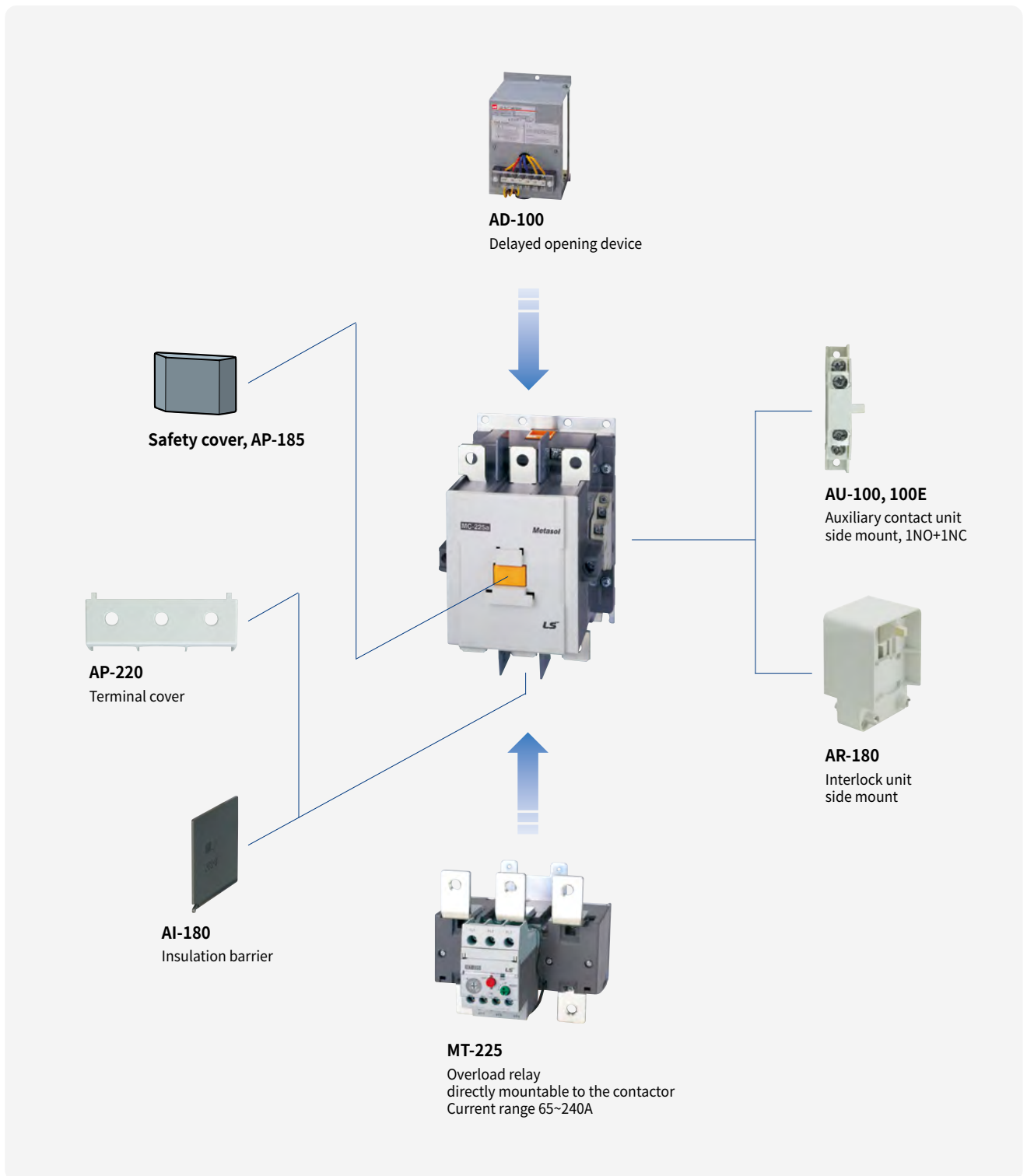

Contactors

Description 400AF

- 3-pole main contact
- AC/DC common use coil built
- Wide coil operation voltage
- Screw mountable
- 2NO+2NC Auxiliary contacts built-in as standard
- Side mountable accessories available
- Degree of protection: IP00



MC-400a

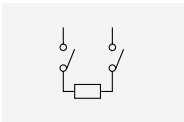

2pole for DC contact

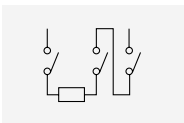

3pole for DC contact

Rating

| Contactor type | | | MC-265a | | MC-330a | | MC-400a | |
|--|------------------------|---------------------|---------|---------|-----------------------|---------|---------|-----|
| | | | kW | A | kW | A | kW | A |
| AC duty | AC3 | 200/240V | 80 | 265 | 90 | 330 | 125 | 400 |
| | | 380/440V | 147 | 265 | 160 | 330 | 200 | 400 |
| | | 500/550V | 147 | 225 | 160 | 280 | 225 | 350 |
| | | 690V | 160 | 185 | 200 | 220 | 250 | 300 |
| | | 1000V | 147 | 105 | 147 | 105 | 147 | 105 |
| | AC4 | 200/240V | 50 | 200 | 55 | 220 | 75 | 300 |
| | | 380/440V | 102 | 200 | 110 | 220 | 150 | 300 |
| | AC1 | | - | 400 | - | 500 | - | 520 |
| | DC1 duty (L/R=15ms) | 2-pole in series | 24V | - | 220 | - | 300 | - |
| 48V | | | - | 180 | - | 240 | - | 240 |
| 110V | | | - | 150 | - | 200 | - | 200 |
| 3-pole in series | | 24V | - | 220 | - | 300 | - | 400 |
| | | 48V | - | 220 | - | 300 | - | 400 |
| | | 110V | - | 220 | - | 300 | - | 400 |
| DC3, 5 duty (L/R=15ms) | 2-pole in series | 24V | - | 220 | - | 300 | - | 400 |
| | | 48V | - | 150 | - | 200 | - | 200 |
| | | 110V | - | 120 | - | 150 | - | 150 |
| | 3-pole in series | 24V | - | 220 | - | 300 | - | 400 |
| | | 48V | - | 220 | - | 280 | - | 280 |
| | | 110V | - | 150 | - | 200 | - | 200 |
| Directly mountable overload relay | | | | | MT-400 | | | |
| Conductor size (Solid, stranded) (The max. number of conducts: 2) | AWG | 3/0~500 | | 4/0~500 | | 350~700 | | |
| | mm ² | 95~240 | | 95~240 | | 185~370 | | |
| Conductor type | | | | | 75°C Cu stranded wire | | | |



Coil voltage, AC/DC common

| Nominal(ordering) voltage | AC 50/60Hz | DC | Certification • CE(IEC) • UL508 • CCC |
|---------------------------|------------|------------|--|
| 100V / 200V | 100 - 240V | 100 - 110V | |
| 300V | 265 - 347V | - | |
| 400V | 380 - 450V | - | |
| 500V | 440 - 575V | - | |

Accessories

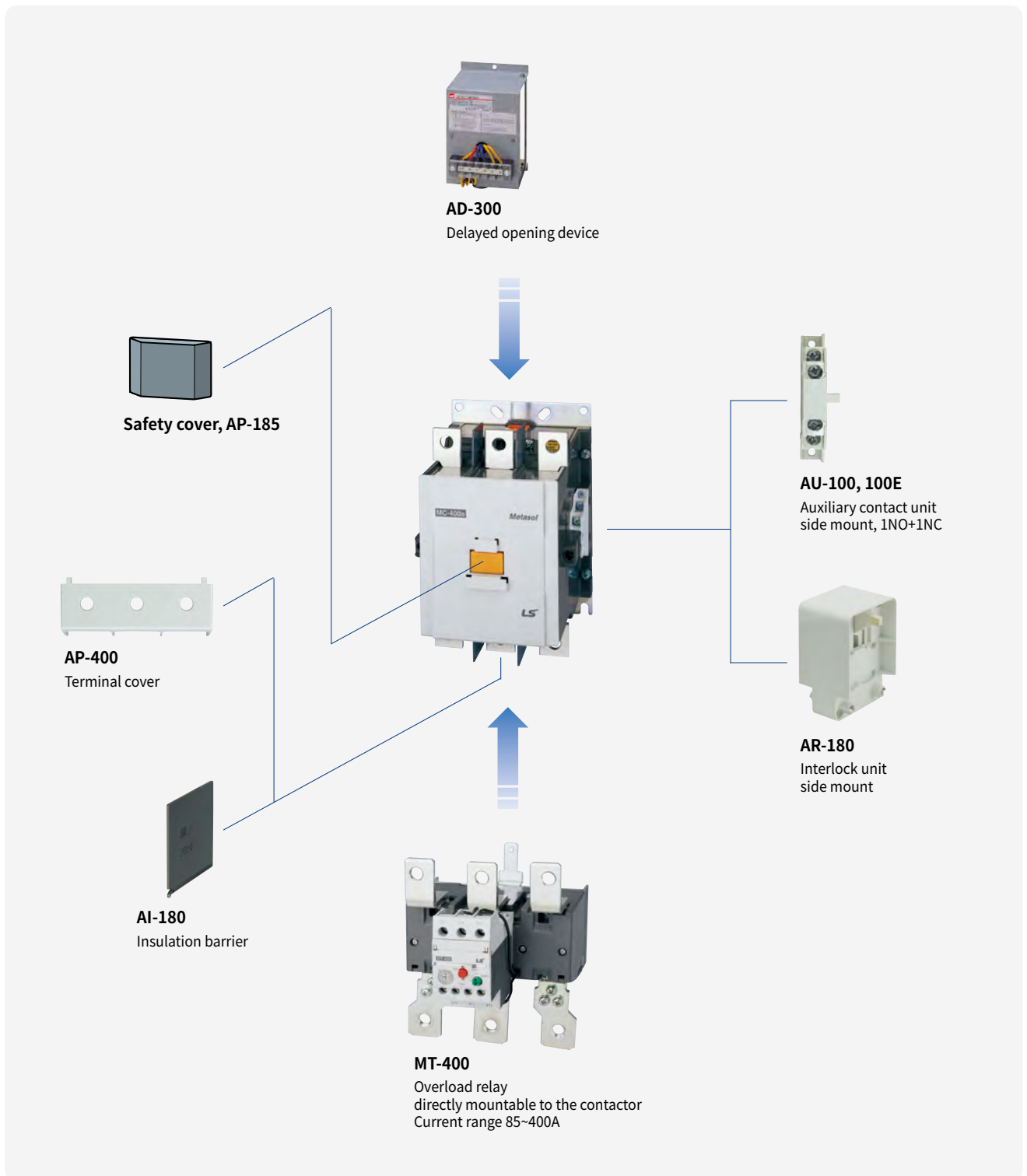

Contactors

Description 800AF

- 3-pole main contact
- AC/DC common use coil built
- Wide coil operation voltage
- Screw mountable
- 2NO+2NC Auxiliary contacts built-in as standard
- Top/side mountable accessories available
- Overload relays available
- Degree of protection: IP00



MC-800a

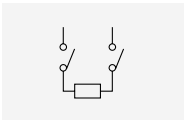

2pole for DC contact

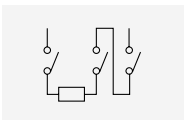

3pole for DC contact

Rating

| Contactor type | | | MC-500a | | MC-630a | | MC-800a | | |
|--|-----------------------|---------------------|-----------------------|----------|---------|-------------|---------|------|-----|
| | | | kW | A | kW | A | kW | A | |
| AC duty | AC3 | 200/240V | 147 | 500 | 190 | 630 | 220 | 800 | |
| | | 380/440V | 265 | 500 | 330 | 630 | 440 | 800 | |
| | | 500/550V | 265 | 400 | 330 | 500 | 500 | 720 | |
| | | 690V | 300 | 380 | 400 | 420 | 500 | 630 | |
| | | 1000V | 280 | 220 | 280 | 220 | 280 | 220 | |
| | AC4 | 200/240V | 90 | 350 | 110 | 400 | 160 | 630 | |
| | | 380/440V | 176 | 350 | 200 | 400 | 300 | 630 | |
| | AC1 | | - | 700 | - | 900 | - | 1050 | |
| | DC1 duty (L/R=1ms) | 2-pole in series | 24V | - | 400 | - | 630 | - | 800 |
| 48V | | | - | 240 | - | 630 | - | 800 | |
| 110V | | | - | 200 | - | 630 | - | 630 | |
| 3-pole in series | | 24V | - | 400 | - | 630 | - | 800 | |
| | | 48V | - | 400 | - | 630 | - | 800 | |
| | | 110V | - | 400 | - | 630 | - | 800 | |
| DC3, 5 duty (L/R=15ms) | | 2-pole in series | 24V | - | 400 | - | 630 | - | 800 |
| | | | 48V | - | 200 | - | 630 | - | 630 |
| | | | 110V | - | 150 | - | 630 | - | 630 |
| | 3-pole in series | 24V | - | 400 | - | 630 | - | 800 | |
| | | 48V | - | 280 | - | 630 | - | 630 | |
| | | 110V | - | 200 | - | 630 | - | 630 | |
| Directly mountable overload relay | | | MT-800 | | | | | | |
| Conductor size (Solid, stranded) (The max. number of conducts: 2) | AWG | 350~800 | | 600~2000 | | 1700~Busbar | | | |
| | mm ² | 185~480 | | - | | - | | | |
| Conductor type | | | 75°C Cu stranded wire | | | | | | |



Coil voltage, AC/DC common

| Nominal(ordering) voltage | AC 50/60Hz | DC | Certification • CE(IEC) • UL508 • CCC |
|---------------------------|------------|------------|--|
| 100V | 100 - 127V | 100 - 110V | |
| 200V | 200 - 240V | 200 - 220V | |
| 300V | 265 - 347V | - | |
| 400V | 380 - 450V | - | |
| 500V | 440 - 575V | - | |

Accessories

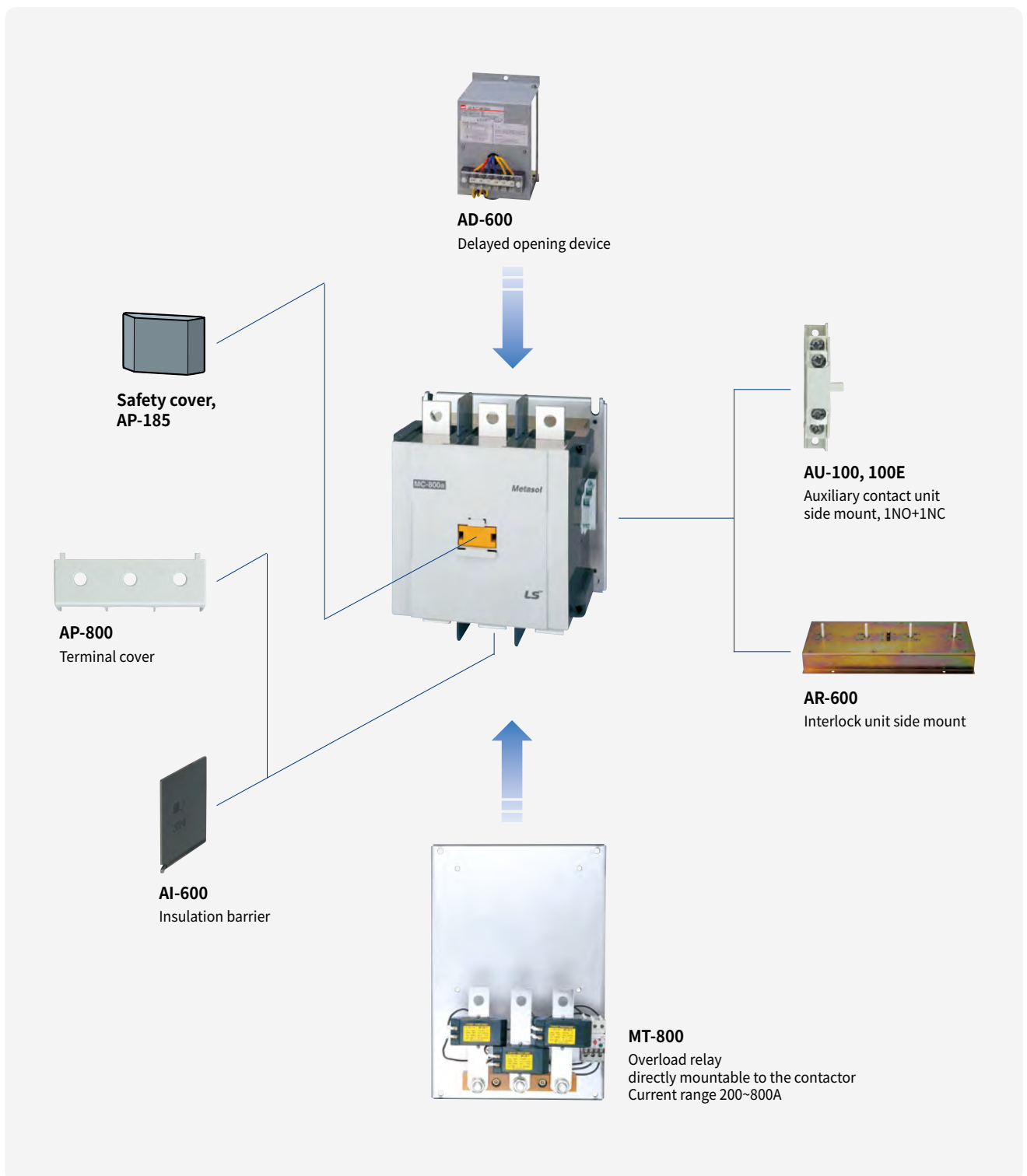

Contactors

Description 1260AF

- 3-pole main contact
- AC/DC common use coil built
- Wide coil operation voltage
- Screw mountable
- 2NO+2NC Auxiliary contacts built-in as standard
- Side mountable accessories available
- Degree of protection: IP00



MC-1260a

Rating

| Contactor type | | MC-1260a | | |
|---------------------------------------|--------|---------------|------|---|
| | | kW | A | |
| AC duty | AC3 | 200/240V | - | - |
| | | 380/440V | - | - |
| | | 500/550V | - | - |
| | | 690V | - | - |
| | | 1000V | - | - |
| | AC1 | - | 1260 | |
| Conductor size (Solid, stranded) (mm) | Busbar | 50 x 10 x 2ea | | |
| Conductor type | Busbar | | | |

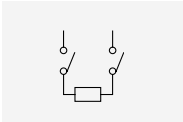

2pole for DC contact

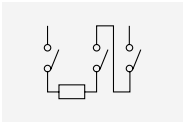

3pole for DC contact



Coil voltage, AC/DC common

| Nominal(ordering) voltage | AC 50/60Hz | DC |
|---------------------------|------------|------------|
| 100V / 200V | 100 - 240V | 100 - 220V |

| Certification |
|---|
| <ul style="list-style-type: none"> • CE(IEC) • UL, UL/cUL |

Accessories



AI-800
Insulation barrier

AU-100, 100E
Auxiliary contact unit
side mount, 1NO+1NC

Contactors

Description 2650AF

- 3-pole main contact
- AC/DC common use coil built
- Wide coil operation voltage
- Screw mountable
- 2NO+2NC Auxiliary contacts built-in as standard
- Side mountable accessories available
- Degree of protection: IP00



Rating

| Contactor type | | | MC-1400a | | MC-1700a | | MC-2100a | | MC-2650a | |
|---------------------------------------|--------|----------|---------------|------|---------------|------|---------------|------|----------------|------|
| | | | kW | A | kW | A | kW | A | kW | A |
| AC duty | AC3 | 200/240V | 290 | 860 | 310 | 1050 | - | - | - | - |
| | | 380/440V | 550 | 860 | 700 | 1050 | 900 | 1450 | - | - |
| | | 500/550V | - | - | - | - | - | - | - | - |
| | | 690V | 800 | 800 | 1000 | 950 | - | - | - | - |
| | | 1000V | - | - | - | - | - | - | - | - |
| | AC1 | | - | 1400 | - | 1700 | - | 2100 | - | 2650 |
| Conductor size (Solid, stranded) (mm) | Busbar | | 100 x 5 x 2ea | | 100 x 5 x 3ea | | 100 x 5 x 4ea | | 100 x 10 x 3ea | |
| Conductor type | | | Busbar | | | | | | | |



Coil voltage, AC/DC common

| Nominal(ordering) voltage | AC 50/60Hz | DC |
|---------------------------|------------|------------|
| 100V / 200V | 100 - 240V | 100 - 220V |

| Certification |
|---|
| <ul style="list-style-type: none"> • CE(IEC) • UL60947-4-1 • CCC |

Accessories



Insulation barrier
AI-2100(MC-1400a~2100a)
AI-2650(MC-2650a)

AU-100, 100E
Auxiliary contact unit
side mount, 1NO+1NC

Renewal Magnetic Contactor

Accessories 1260AF

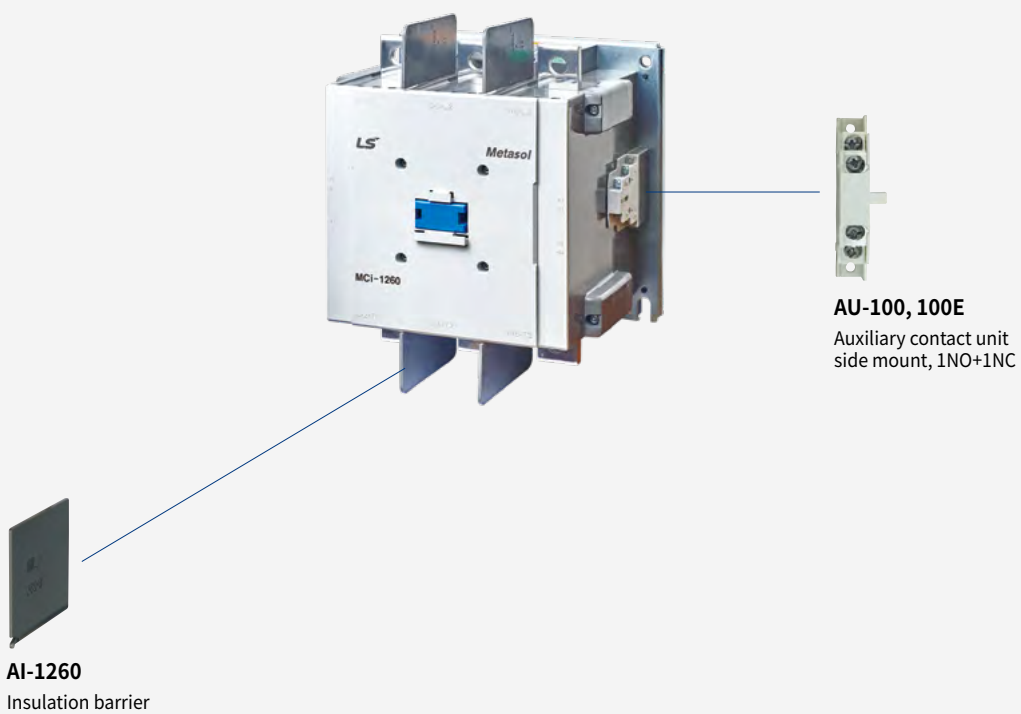

Accessories 2650AF

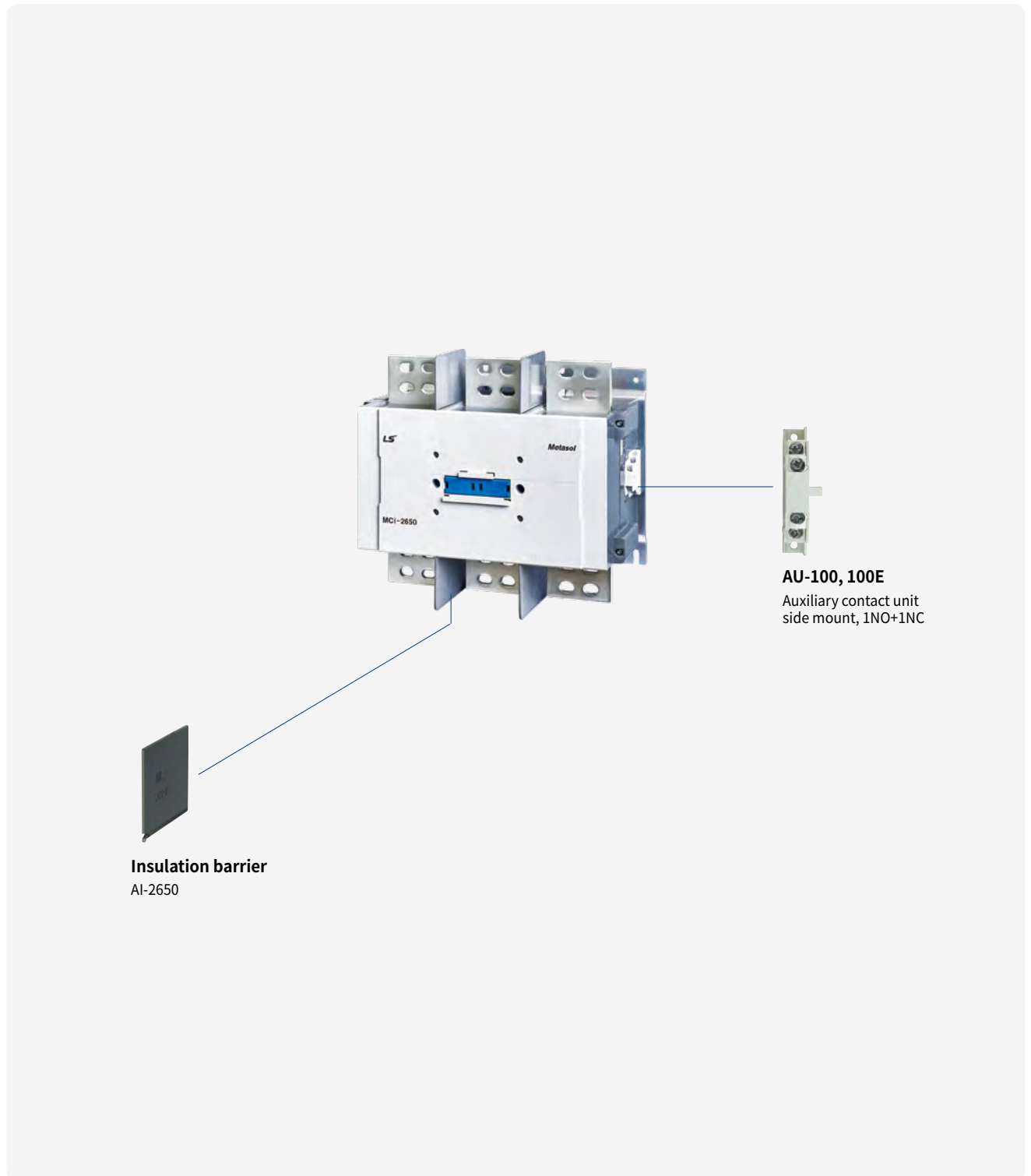

Insulation barrier
AI-2650

AU-100, 100E
Auxiliary contact unit
side mount, 1NO+1NC

Motor starters

Description

- Opened direct motor starter
- 3-pole(NO) main contact
- Finger proof design
- DIN rail or screw mountable
- AC or DC control contactor selectable
- Front/side mountable accessories available
- Overload relay is directly mounted to the contactor
- Degree of protection: IP20



Rating

| Frame size | | | | 18AF | | | | 22AF | | | |
|---|------------------------------|-------------|------|-------|-------|--------|--------|-------|--------|--------|--------|
| Type | | | | MC-6a | MC-9a | MC-12a | MC-18a | MC-9b | MC-12b | MC-18b | MC-22b |
| Number of poles | | | | 3 | | | | 3 | | | |
| Rated operational voltage (Ue) | | | | 690V | | | | 690V | | | |
| Degree of pollution (IEC60529) | | | | IP20 | | | | IP20 | | | |
| Rated operational current Ie (θ≤40°C) | AC-1 | Ue max 690V | [A] | 25 | 25 | 25 | 32 | 25 | 27 | 40 | 45 |
| | AC-3 | 200/240V | [A] | 9 | 11 | 13 | 18 | 11 | 13 | 18 | 22 |
| | | 380/400V | [A] | 7 | 9 | 12 | 18 | 9 | 12 | 18 | 22 |
| | | 415V | [A] | 7 | 9 | 12 | 18 | 9 | 12 | 18 | 22 |
| | | 440V | [A] | 7 | 9 | 12 | 18 | 9 | 12 | 18 | 22 |
| | | 500V | [A] | 6 | 7 | 12 | 13 | 7 | 12 | 13 | 20 |
| | | 690V | [A] | 4 | 5 | 9 | 9 | 6 | 9 | 9 | 18 |
| 1000V | [A] | - | - | - | - | - | - | - | - | - | |
| Rated operational power (θ≤40°C) | AC-3 | 200/240V | [kW] | 2.2 | 2.5 | 3.5 | 4.5 | 2.5 | 3.5 | 4.5 | 5.5 |
| | | 380/400V | [kW] | 3 | 4 | 5.5 | 7.5 | 4 | 5.5 | 7.5 | 11 |
| | | 415V | [kW] | 3 | 4 | 5.5 | 7.5 | 4 | 5.5 | 7.5 | 11 |
| | | 440V | [kW] | 3 | 4 | 5.5 | 7.5 | 4 | 5.5 | 7.5 | 11 |
| | | 500V | [kW] | 3 | 4 | 7.5 | 7.5 | 4 | 7.5 | 7.5 | 15 |
| | | 690V | [kW] | 3 | 4 | 7.5 | 7.5 | 4 | 7.5 | 7.5 | 15 |
| 1000V | [kW] | - | - | - | - | - | - | - | - | - | |
| According to IEC60947-4-1 | Rated making capacity AC-3 | | | 70 | 90 | 120 | 180 | 90 | 120 | 180 | 220 |
| | Rated breaking capacity AC-3 | | | 56 | 72 | 96 | 144 | 72 | 96 | 144 | 176 |
| Electrical life for Ie / AC-3 Max in millions of operating cycles | | | | 2.5 | 2.5 | 2.5 | 2.5 | 2.5 | 2.5 | 2.5 | 2.5 |
| Maximum operating rate in operating cycles per hour | | | | 1800 | 1800 | 1800 | 1800 | 1800 | 1800 | 1800 | 1800 |

Devices usable in the starter combination

| Contactors | | | 18AF | | | | 22AF | | | |
|---------------------------------------|---------------------------------|--|----------|-------|--------|--------|----------|--------|--------|--------|
| with AC or DC control coil | | | MC-6a | MC-9a | MC-12a | MC-18a | MC-9b | MC-12b | MC-18b | MC-22b |
| with coil in common use for AC and DC | | | - | - | - | - | - | - | - | - |
| Thermal overload relays | | | 18AF | | | | 22AF | | | |
| Class 10 | Differential type | | MT-12/3K | | | | MT-32/3K | | | |
| | Non-differential type | | MT-12/3H | | | | MT-32/3H | | | |
| | Non-differential type(2-heater) | | MT-12/2H | | | | MT-32/2H | | | |
| Class 20 | Differential type | | MT-12/3D | | | | MT-32/3D | | | |
| Setting range A | | | 0.1~18A | | | | 0.1~40A | | | |



| 40AF | | 65AF | | 100AF | | |
|--------|--------|--------|--------|--------|--------|---------|
| MC-32a | MC-40a | MC-50a | MC-65a | MC-75a | MC-85a | MC-100a |
| 3 | | 3 | | 3 | | |
| 690V | | 690V | | 690V | | |
| IP20 | | IP20 | | IP20 | | |
| 55 | 60 | 100 | 115 | 125 | 135 | 160 |
| 32 | 40 | 55 | 65 | 75 | 85 | 105 |
| 32 | 40 | 50 | 65 | 75 | 85 | 105 |
| 32 | 40 | 50 | 65 | 75 | 85 | 105 |
| 32 | 40 | 50 | 65 | 75 | 85 | 105 |
| 28 | 32 | 43 | 60 | 64 | 75 | 85 |
| 20 | 23 | 28 | 35 | 42 | 45 | 65 |
| 17 | 17 | 23 | 23 | 28 | 28 | 28 |
| 7.5 | 11 | 15 | 18.5 | 22 | 25 | 30 |
| 15 | 18.5 | 22 | 30 | 37 | 45 | 55 |
| 15 | 18.5 | 22 | 30 | 37 | 45 | 55 |
| 15 | 18.5 | 22 | 30 | 37 | 45 | 55 |
| 18.5 | 22 | 30 | 33 | 37 | 45 | 55 |
| 18.5 | 22 | 30 | 33 | 37 | 45 | 55 |
| 22 | 22 | 30 | 30 | 37 | 37 | 37 |
| 320 | 400 | 500 | 650 | 750 | 850 | 1050 |
| 256 | 320 | 400 | 520 | 600 | 650 | 840 |
| 2 | 2 | 2 | 2 | 2 | 2 | 2 |
| 1800 | 1800 | 1200 | 1200 | 1200 | 1200 | 1200 |

| 40AF | | 65AF | | 100AF | | |
|----------|--------|----------|--------|----------|--------|---------|
| MC-32a | MC-40a | MC-50a | MC-65a | MC-75a | MC-85a | MC-100a |
| - | - | - | - | - | - | - |
| 40AF | | 65AF | | 100AF | | |
| MT-32/3K | | MT-63/3K | | MT-95/3K | | |
| MT-32/3H | | MT-63/3H | | MT-95/3H | | |
| MT-32/2H | | MT-63/2H | | MT-95/2H | | |
| MT-32/3D | | MT-63/3D | | MT-95/3D | | |
| 0.1~40A | | 4~65A | | 7~100A | | |

Motor starters

Description

- Opened direct motor starter
- 3-pole(NO) main contacts
- Screw mountable
- AC/DC common use control contactor used (from 225AF)
- Additional accessories available
- Overload relay is directly mounted to the contactor
- Degree of protection: IP20



Rating

| Frame size | | | | 150AF | | 225AF | | |
|---|------------------------------|-------------|------|---------|---------|---------|---------|--|
| Type | | | | MS-130a | MS-150a | MS-185a | MS-225a | |
| Number of poles | | | | 3 | | 3 | | |
| Rated operational voltage (Ue) | | | | 690V | | 690V | | |
| Degree of pollution (IEC60529) | | | | IP20 | | IP20 | | |
| Rated operational current Ie (θ≤40°C) | AC-1 | Ue max 690V | [A] | 200 | 250 | 300 | 350 | |
| | | AC-3 | | 130 | 150 | 185 | 225 | |
| | | 200/240V | [A] | 130 | 150 | 185 | 225 | |
| | | 380/400V | [A] | 130 | 150 | 185 | 225 | |
| | | 415V | [A] | 130 | 150 | 185 | 225 | |
| | | 440V | [A] | 130 | 150 | 185 | 225 | |
| | | 500V | [A] | 90 | 100 | 180 | 200 | |
| | 690V | [A] | 60 | 60 | 120 | 150 | | |
| | 1000V | [A] | 50 | 50 | 90 | 90 | | |
| Rated operational power (θ≤40°C) | AC-3 | 200/240V | [kW] | 37 | 45 | 55 | 75 | |
| | | 380/400V | [kW] | 60 | 75 | 90 | 132 | |
| | | 415V | [kW] | 60 | 75 | 90 | 132 | |
| | | 440V | [kW] | 60 | 75 | 90 | 132 | |
| | | 500V | [kW] | 60 | 70 | 110 | 132 | |
| | | 690V | [kW] | 55 | 55 | 110 | 140 | |
| | 1000V | [kW] | 75 | 90 | 132 | 132 | | |
| According to IEC60947-4-1 | Rated making capacity AC-3 | | | 1200 | 1500 | 1850 | 2250 | |
| | Rated breaking capacity AC-3 | | | 960 | 1200 | 1480 | 1800 | |
| Electrical life for Ie / AC-3 Max in millions of operating cycles | | | | 1 | 1 | 1 | 1 | |
| Maximum operating rate in operating cycles per hour | | | | 1200 | 1200 | 1200 | 1200 | |

Devices usable in the starter combination

| Contactors | | | 150AF | | 225AF | | |
|---------------------------------------|---------------------------------|--|-----------|---------|-----------|---------|--|
| with AC or DC control coil | | | MC-130a | MC-150a | - | - | |
| with coil in common use for AC and DC | | | - | - | MC-185a | MC-225a | |
| Thermal overload relays | | | 150AF | | 225AF | | |
| Class 10 | Differential type | | MT-150/3K | | MT-225/3K | | |
| | Non-differential type | | MT-150/3H | | MT-225/3H | | |
| | Non-differential type(2-heater) | | MT-150/2H | | MT-225/2H | | |
| Class 20 | Differential type | | MT-150/3D | | MT-225/3D | | |
| Setting range A | | | 34~150A | | 65~240A | | |



| | 400AF | | | 800AF | | |
|--|---------|---------|---------|---------|---------|---------|
| | MS-265a | MS-330a | MS-400a | MS-500a | MS-630a | MS-800a |
| | | 3 | | | 3 | |
| | | 690V | | | 690V | |
| | | IP20 | | | IP20 | |
| | 400 | 500 | 520 | 700 | 900 | 1050 |
| | 265 | 330 | 400 | 500 | 630 | 800 |
| | 265 | 330 | 400 | 500 | 630 | 800 |
| | 265 | 330 | 400 | 500 | 630 | 800 |
| | 265 | 330 | 400 | 500 | 630 | 800 |
| | 225 | 280 | 350 | 400 | 500 | 720 |
| | 185 | 220 | 300 | 380 | 420 | 630 |
| | 105 | 105 | 105 | 220 | 220 | 220 |
| | 80 | 90 | 125 | 147 | 190 | 220 |
| | 147 | 160 | 200 | 265 | 330 | 440 |
| | 147 | 160 | 200 | 265 | 330 | 440 |
| | 147 | 160 | 200 | 265 | 330 | 440 |
| | 147 | 160 | 225 | 265 | 330 | 500 |
| | 160 | 200 | 250 | 300 | 400 | 500 |
| | 147 | 147 | 147 | 280 | 280 | 280 |
| | 2650 | 3300 | 4000 | 5000 | 6300 | 8000 |
| | 2120 | 2640 | 3200 | 4000 | 5040 | 6400 |
| | 1 | 1 | 0.5 | 0.5 | 0.5 | 0.5 |
| | 1200 | 1200 | 1200 | 1200 | 1200 | 1200 |

| | 400AF | | | 800AF | | | |
|--|---------|-----------|---------|---------|-----------|---------|--|
| | - | - | - | - | - | - | |
| | MC-265a | MC-330a | MC-400a | MC-500a | MC-630a | MC-800a | |
| | | 400AF | | | 800AF | | |
| | | MT-400/3K | | | MT-800/3K | | |
| | | MT-400/3H | | | MT-800/3H | | |
| | | MT-400/2H | | | MT-800/2H | | |
| | | MT-400/3D | | | MT-800/3D | | |
| | | 85~400A | | | 200~800A | | |

Reversing contactors

Description

- Two AC or DC control contactors are interlocked mechanically and electrically
- 3-pole(NO) main contact in each contactor
- Finger proof design
- DIN rail or screw mountable
- Front/side mountable accessories available
- Overload relay can be directly mounted to the contactor if necessary
- Please use interval time of over 25ms
- Degree of protection: IP20

Circuit diagram

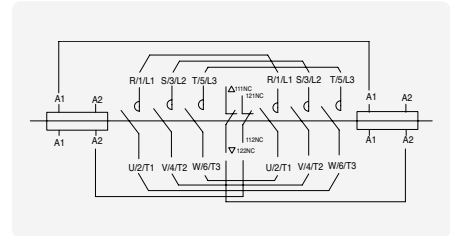

Rating

| Type | AC-3 duty | | | | | | | Current (AC3) | Weight (AC control) |
|-----------|-----------|----------|------|------|------|------|-------|---------------|---------------------|
| | 200~240V | 380~400V | 415V | 440V | 500V | 690V | 1000V | 440V | |
| | kW | kW | kW | kW | kW | kW | kW | A | |
| MC-6a/R | 2.2 | 3 | 3 | 3 | 3 | 3 | - | 7 | 0.63kg |
| MC-9a/R | 2.5 | 4 | 4 | 4 | 4 | 4 | - | 9 | 0.63kg |
| MC-12a/R | 3.5 | 5.5 | 5.5 | 5.5 | 7.5 | 7.5 | - | 12 | 0.63kg |
| MC-18a/R | 4.5 | 7.5 | 7.5 | 7.5 | 7.5 | 7.5 | - | 18 | 0.63kg |
| MC-9b/R | 2.5 | 4 | 4 | 4 | 4 | 4 | - | 9 | 0.75kg |
| MC-12b/R | 3.5 | 5.5 | 5.5 | 5.5 | 7.5 | 7.5 | - | 12 | 0.75kg |
| MC-18b/R | 4.5 | 7.5 | 7.5 | 7.5 | 7.5 | 7.5 | - | 18 | 0.75kg |
| MC-22b/R | 5.5 | 11 | 11 | 11 | 15 | 15 | - | 22 | 0.75kg |
| MC-32a/R | 7.5 | 15 | 15 | 15 | 18.5 | 18.5 | 22 | 32 | 0.95kg |
| MC-40a/R | 11 | 18.5 | 18.5 | 18.5 | 22 | 22 | 22 | 40 | 0.95kg |
| MC-50a/R | 15 | 22 | 22 | 22 | 30 | 30 | 30 | 50 | 1.9kg |
| MC-65a/R | 18.5 | 30 | 30 | 30 | 33 | 33 | 30 | 65 | 1.9kg |
| MC-75a/R | 22 | 37 | 37 | 37 | 37 | 37 | 37 | 75 | 3.4kg |
| MC-85a/R | 25 | 45 | 45 | 45 | 45 | 45 | 37 | 85 | 3.4kg |
| MC-100a/R | 30 | 55 | 55 | 55 | 55 | 55 | 37 | 105 | 3.4kg |



MC-40a/R



MC-65a/R



MC-100a/R



Coil voltage

| | | |
|----|------|---|
| AC | 50Hz | 24, 32, 42, 48, 80, 100, 110, 220, 230, 240, 380, 400, 500, 550V |
| | 60Hz | 24, 48, 100, 110, 120, 200, 208, 220, 230, 240, 277, 380, 480, 600V |
| DC | | 12, 20, 24, 48, 60, 80, 100, 110, 125, 200, 220, 250V |

| Certification |
|---------------|
| • CE(IEC) |
| • UL508 |
| • CCC |

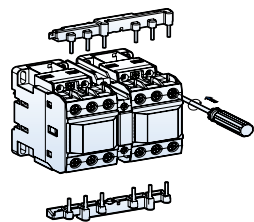

Description

- 3-pole main contact
- Mechanically interlocked
- AC/DC common use coil built (from MC-185a/R)
- Wide coil operation voltage
- Screw mountable
- 4NO4NC Auxiliary contacts built-in
- Top/side mountable accessories available
- Please use interval time of over 50ms
- Degree of protection: IP20



Rating

| Type | AC-3 duty | | | | | | | Current (AC3) | Weight (AC control) |
|-----------|-----------|----------|------|------|------|------|-------|---------------|---------------------|
| | 200~240V | 380~400V | 415V | 440V | 500V | 690V | 1000V | 440V | |
| | kW | kW | kW | kW | kW | kW | kW | A | |
| MC-130a/R | 37 | 60 | 60 | 60 | 60 | 55 | 75 | 130 | 4.3kg |
| MC-150a/R | 45 | 75 | 75 | 75 | 70 | 55 | 75 | 150 | 4.3kg |
| MC-185a/R | 55 | 90 | 90 | 90 | 110 | 110 | 132 | 185 | 13kg |
| MC-225a/R | 75 | 132 | 132 | 132 | 132 | 140 | 132 | 225 | 13kg |
| MC-265a/R | 80 | 147 | 147 | 147 | 147 | 160 | 147 | 265 | 21.4kg |
| MC-330a/R | 90 | 160 | 160 | 160 | 160 | 200 | 147 | 330 | 21.4kg |
| MC-400a/R | 125 | 200 | 200 | 225 | 225 | 250 | 147 | 400 | 21.4kg |
| MC-500a/R | 147 | 265 | 265 | 265 | 265 | 300 | 280 | 500 | 60kg |
| MC-630a/R | 190 | 330 | 330 | 330 | 330 | 400 | 280 | 630 | 60kg |
| MC-800a/R | 220 | 440 | 440 | 440 | 440 | 500 | 280 | 800 | 60kg |



Coil voltage

| For MC130a/R and MC-150a/R | AC | 50/60Hz | 24, 48, 100~240, 110~120, 220~240, 300, 380~440, 500V |
|----------------------------|----|---------|---|
| | | DC | |

| | |
|---------------------------|--|
| For MC-185a/R ~ MC-800a/R | - 24, 48, 100/200, 300, 400, 500V for types MC-185a/R, 225a/R - 100/200, 300, 400, 500V for types MC-265a/R, 330a/R, 400a/R - 100, 200, 300, 400, 500V for types MC-500a/R, 600a/R, 800a/R |
|---------------------------|--|

| Nominal(ordering) voltage | AC 50/60Hz | DC |
|---------------------------|------------|------------|
| 24V | 24 - 25V | 24V |
| 48V | 48 - 50V | 48V |
| 100V | 100 - 127V | 100 - 110V |
| 200V | 200 - 240V | 200 - 220V |
| 100/200V | 100 - 240V | 100 - 220V |
| 300V | 265 - 347V | - |
| 400V | 380 - 450V | - |
| 500V | 440 - 575V | - |

LED voltage monitoring contactor

Description



Real time observe coil voltage without additional equipments for protect coil burn out due to the under and over voltage

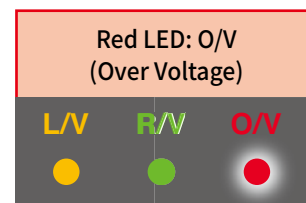
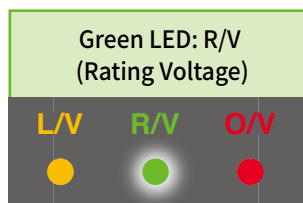
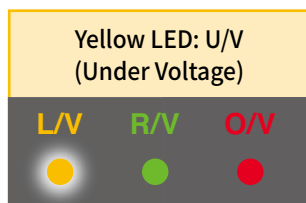

Coil voltage

| Type | Coil voltage | LED indicate statue | | |
|-----------------------------|--------------|------------------------|------------------------|--------------------|
| | | Under voltage (Yellow) | Rating voltage (Green) | Over voltage (Red) |
| MC-130a, MC 150a | 110V | ~80V | 80~130V | 130V~ |
| | 220V | ~160V | 160~260V | 260V~ |
| | 400V | ~330V | 330~480V | 280V~ |
| MC-185a, MC-225a | 110V | ~80V | 80~130V | 130V~ |
| | 220V | ~160V | 160~260V | 260V~ |
| | 400V | ~330V | 330~480V | 280V~ |
| MC-265a, MC-330a MC-400a | 110V | ~80V | 80~130V | 130V~ |
| | 220V | ~160V | 160~260V | 260V~ |
| | 400V | ~330V | 330~480V | 280V~ |
| MC-500a, MC-630a MC-800a | 110V | ~80V | 80~130V | 130V~ |
| | 220V | ~160V | 160~260V | 260V~ |

* The accuracy of LED indicate statue is $\pm 5\%$

Description

- 4,6,8 pole units
- AC/DC control voltage
- 16A continuous current, lth
- DIN rail or screw mountable
- Degree of protection: IP20

Selection



MR-4



MR-6



MR-8

| Poles | Composition | Types | Remarks |
|--------|---|-------|---|
| 4 pole | 4NO 3NO1NC 2NO2NC 1NO3NC 4NC | MR-4 | Additional auxiliary contacts can be mounted on the relays. |
| 6 pole | 6NO 5NO1NC 4NO2NC 3NO3NC 2NO4NC | MR-6 | UA-2 is mounted on the MR-4. |
| 8 pole | 8NO 7NO1NC 6NO2NC 5NO3NC 4NO4NC | MR-8 | UA-4 is mounted on the MR-4. |

Note) Product indicated "Low" is for Low current application

Rating

| | | | | | | | |
|-------------------------------|----------------------|----------------------|------|------|------|------|------|
| Rated insulation voltage (Ui) | | AC 690V | | | | | |
| Continuous current (lth) | | 16A | | | | | |
| Operating cycle | | 1800 operations/hour | | | | | |
| Endurance | Mechanical life time | 10 mil. operations | | | | | |
| | Electrical life time | 0.25 mil. operations | | | | | |
| Type | | MR-4 | MR-6 | MR-8 | | | |
| AC-15 | Rated current (A) | 120V | 6 | 6 | 6 | | |
| | | 240V | 3 | 3 | 3 | | |
| | | 380V | 1.9 | 1.9 | 1.9 | | |
| | | 480V | 1.5 | 1.5 | 1.5 | | |
| | | 500V | 1.4 | 1.4 | 1.4 | | |
| | | 600V | 1.2 | 1.2 | 1.2 | | |
| DC-13 | Rated current (A) | 125V | 1.1 | 1.1 | 0.55 | 1.1 | 0.55 |
| | | 250V | 0.55 | 0.55 | 0.27 | 0.55 | 0.27 |
| | | 400V | 0.31 | 0.31 | 0.15 | 0.31 | 0.15 |
| | | 500V | 0.27 | 0.27 | 0.13 | 0.27 | 0.13 |
| | | 600V | 0.2 | 0.2 | 0.1 | 0.2 | 0.1 |
| Minimum rated through current | | DC 24V 10mA | | | | | |



Coil voltage

| | | |
|---------------|------|---|
| AC | 50Hz | 24, 32, 42, 48, 65, 80, 100, 110, 120, 220, 230, 240, 380, 400, 500, 550V |
| | 60Hz | 24, 48, 110, 120, 200, 208, 220, 230, 240, 277, 380, 480, 600V |
| DC | | 12, 20, 24, 30, 48, 60, 80, 100, 110, 125, 200, 220, 250V |
| Voltage limit | | 85%~110% |

Note)
See page 22, 23 for details.
* Please be cautious for wiring control power cable, especially "+" (Positive) and "-" (Negative) polarity should be correctly considered.

Contactors relays for micro current

Description

- 2,4,8 pole units
- AC/DC control voltage
- 0.5 mil. operations, 2.5 mil. operations
- DIN rail or screw mountable (35mm)
- Degree of protection: IP20

* Do not place strong magnets around the main circuit.

Type



MR-4E



MR-8E



UA-4E



UA-1E

| Number of poles | Contact configuration | | Types | Remarks |
|-----------------|----------------------------------|----------------------------------|--------------------------|---|
| | Micro contact | Normal contact | | |
| 2 pole | 1a1b | - | UA-1E AU-100E | Auxiliary contact unit (UA-1E) |
| 4 Pole | 2a 1a1b 2b | 2a 1a1b 2b | MR-4E or UA-4E | Auxiliary relay (MR-4E) or Auxiliary contact unit (UA-4E) |
| 8 Pole | 4a 3a1b 2a2b 1a3b 4b | 4a 3a1b 2a2b 1a3b 4b | MR-8E (MR-4E + UA-4E) | Auxiliary relay (MR-4E) and Auxiliary contact unit (UA-4E) |

* MR-4E UA-4E 'Negative sides of both sides' is the contact for microcurrent.

* UA-1E is applicable to 150AF or less. (Above 225AF, AU-100E is available.)

* Please note that contact welding may occur when a high voltage is applied to the contact for micro current, not the rated voltage.

Rating

| | Micro contact | Normal contact |
|--------------------------------|-----------------------|----------------------|
| Rated operational voltage (Ue) | AC 130V, DC 180V MAX. | AC 600V |
| Continuous current (Ith) | 1A | 16A |
| Switching current | 0.7A MAX. | 6A |
| Contact capacity | 10VA (10W) Less | 720VA |
| Rated insulation voltage (Ui) | DC 200V | AC 690V |
| Operating cycle (AC1) | 1800 operations/hour | 1800 operations/hour |
| Endurance | Mechanical | 2.5 mil. operations |
| | Electrical | 0.5 mil. operations |
| Minimum rated through current | DC 5V 0.5mA | DC 24V 10mA |
| Contact reliability | 1×10^{-8} | 4×10^{-6} |



Coil voltage

| | | |
|-------------------|------|---|
| AC | 50Hz | 24, 32, 36, 42, 48, 65, 80, 100, 110, 120, 220, 230, 240, 380, 400, 415, 440, 500, 550V |
| | 60Hz | 24, 48, 110, 120, 200, 208, 220, 230, 240, 277, 380, 440, 480, 600V |
| DC | | 12, 20, 24, 30, 48, 60, 80, 100, 110, 125, 200, 220, 250V |
| Temperature Range | | 85%~110% |

Note) 1. Coil For detailed specifications, refer to Operating Coil Rating and Characteristics data (22AF) on Catalog 22 page.
2. For DC type products, be sure to wire the polarity of the + and - polarities when wiring the coil terminals.

Contact configuration

2a+2a

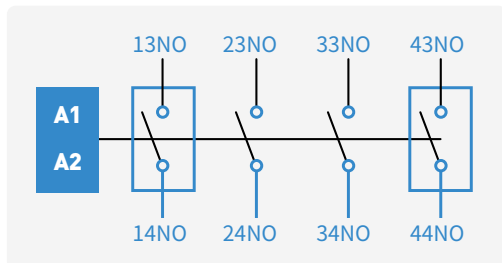

2a+1a1b

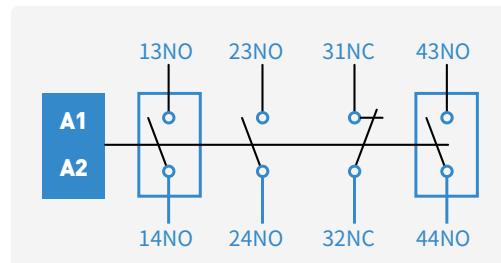

2a+2b

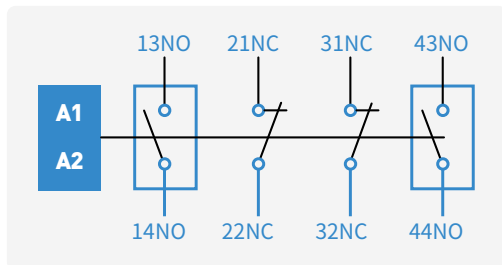

1a1b+2a

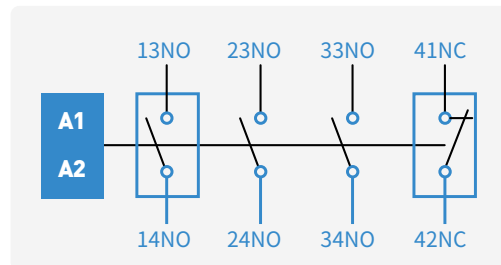

1a1b+1a1b

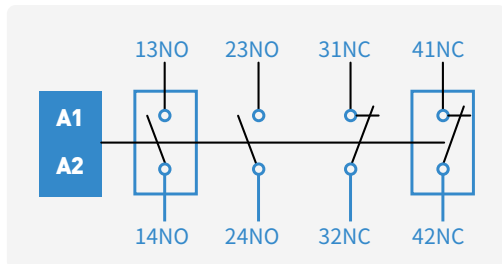

1a1b+2b

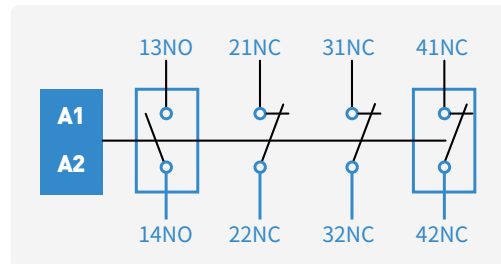

2b+2a

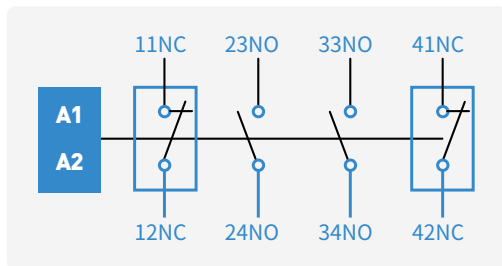

2b+1a1b

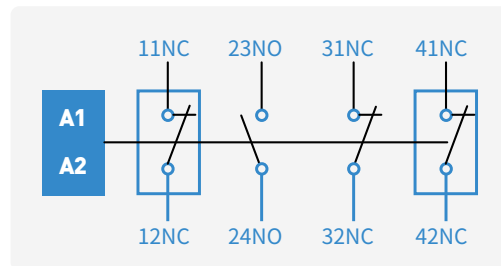

2b+2b

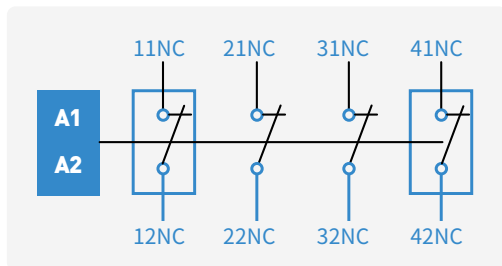

* □ is micro contact.

Latching contactors

Description 6~150AF

- 3-pole main contact
- Mechanically latched
- Finger proof design
- DIN rail or screw mountable
- Side mountable accessories available
- Direct mountable overload relays available

Circuit diagram

MC-6a/L~150a/L

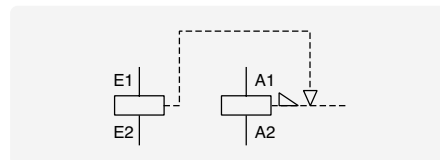

Rating

| Contactor | AC3 ratings | | | | | Devices combined | | | |
|-----------|------------------|------------------|------------------|------------|-------------|------------------|-------------------------|------------------|----------------------|
| | 200 / 240V kW | 380 / 440V kW | 500 / 550V kW | 690V kW | 1000V kW | Type | Durability (Mechanical) | Operational time | Excitation time |
| MC-6a/L | 2.2 | 3 | 3 | 3 | - | ML-65 | 0.5 mil. | Less 30ms (AC) | More than 100ms (AC) |
| MC-9a/L | 2.5 | 4 | 4 | 4 | - | | | | |
| MC-12a/L | 3.5 | 5.5 | 7.5 | 7.5 | - | | | | |
| MC-18a/L | 4.5 | 7.5 | 7.5 | 7.5 | - | | | | |
| MC-9b/L | 2.5 | 4 | 4 | 4 | - | | | | |
| MC-12b/L | 3.5 | 5.5 | 7.5 | 7.5 | - | | | | |
| MC-18b/L | 4.5 | 7.5 | 7.5 | 7.5 | - | | | | |
| MC-22b/L | 5.5 | 11 | 15 | 15 | - | | | | |
| MC-32a/L | 7.5 | 15 | 18.5 | 18.5 | 22 | | | | |
| MC-40a/L | 11 | 18.5 | 22 | 22 | 22 | | | | |
| MC-50a/L | 15 | 22 | 30 | 30 | 30 | ML-150 | 2.5 mil. | Less 50ms (DC) | More than 130ms (DC) |
| MC-65a/L | 18.5 | 30 | 33 | 33 | 30 | | | | |
| MC-75a/L | 22 | 37 | 37 | 37 | 37 | | | | |
| MC-85a/L | 25 | 45 | 45 | 45 | 37 | | | | |
| MC-100a/L | 30 | 55 | 55 | 45 | 37 | | | | |
| MC-130a/L | 37 | 60 | 60 | 55 | 75 | | | | |
| MC-150a/L | 45 | 75 | 75 | 55 | 75 | Less 100ms | More than 130ms | | |

* When the open signal is input for more than 1 second, the coil of the latch is burned.

For MC input signals, please give at least 100ms for AC coil and 250ms for DC coil.

For MC input signal voltage, please use 85% to 110% of the coil rating. Contacts can be in complete due to insufficient input signal when low voltage is applied.



Coil voltage

| | | |
|----|---------|--|
| AC | 50/60Hz | 24, 48, 100, 110, 120, 200, 220, 230, 240, 380, 400, 415, 440V |
| DC | | 24, 48, 110V |

Certification

- CE(IEC)
- UL508

Accessories

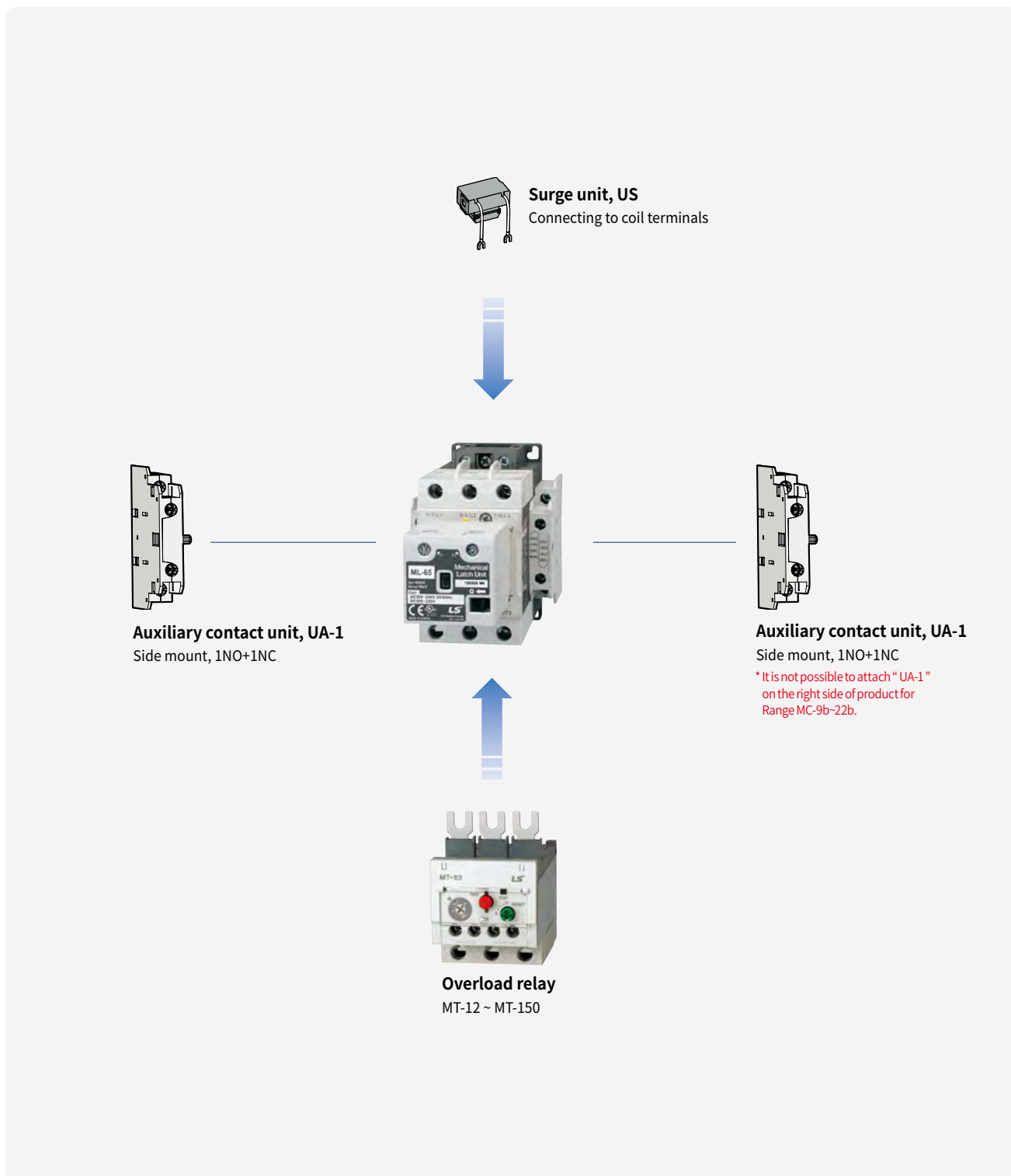

Latching contactors

Description 185~400AF

- 3-pole main contact
- Mechanically interlocked
- AC/DC common use coil built
- Wide coil operation voltage
- Screw mountable
- 1NO+2NC auxiliary contacts built-in as standard
- Top/side mountable accessories available

Circuit diagram

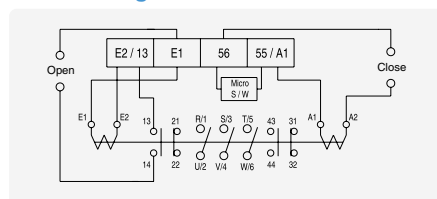

Rating

| Contactor | AC3 ratings | | | | | Auxiliary contact (Standard) |
|-----------|---------------|---------------|---------------|---------------|---------------|------------------------------|
| | 200~240V | 380~440V | 500~550V | 690V | 1000V | |
| MC-185a/L | 55kW 185A | 90kW 185A | 110kW 180A | 110kW 120A | 132kW 90A | 2NO2NC* (1NO2NC) |
| MC-225a/L | 75kW 225A | 132kW 225A | 132kW 200A | 140kW 150A | 132kW 90A | |
| MC-265a/L | 80kW 265A | 147kW 265A | 147kW 225A | 160kW 185A | 147kW 105A | |
| MC-330a/L | 90kW 330A | 160kW 330A | 160kW 280A | 200kW 220A | 147kW 105A | |
| MC-400a/L | 125kW 400A | 200kW 400A | 225kW 350A | 250kW 300A | 147kW 105A | |

* 1NO contact of 2NO2NC is used in Latch and customer contact is 1NO2NC. If 2NO or higher is used, additional attachment of AU-100 is required.



Coil voltage

| Nominal(ordering) voltage | Operational voltage | Operation frequency |
|---------------------------|---------------------|---------------------|
| 100V | AC100~127V | 600 operations/hour |
| | DC100~125V | 300 operations/hour |
| 200V | AC200~240V | 600 operations/hour |
| | DC200~220V | 300 operations/hour |

Accessories

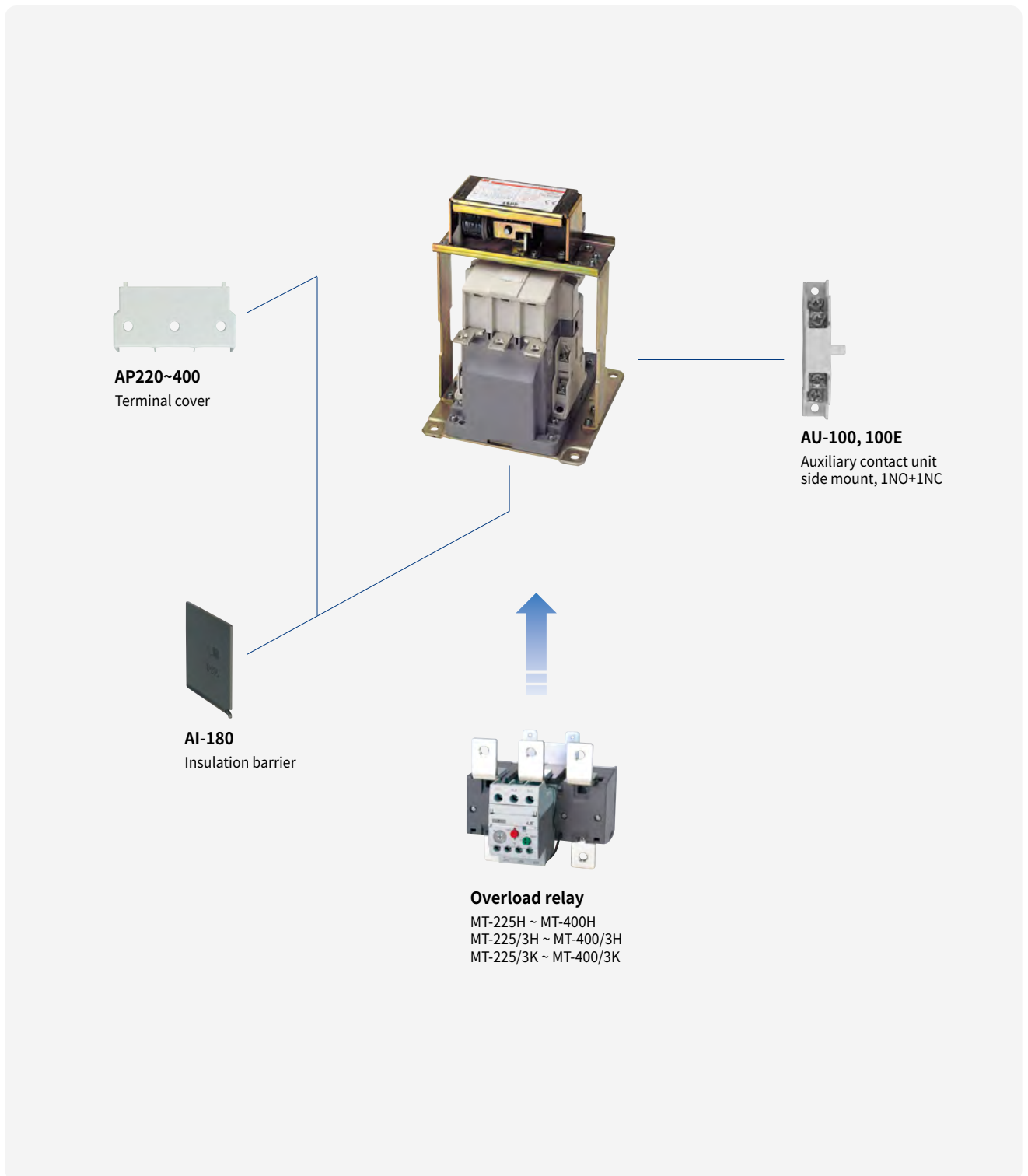

4-pole contactors

Description 18AF

- 4-pole main contact
- Finger proof design
- DIN rail or screw mountable
- Small physical size: 44 mm wide
- Auxiliary contacts are optional
- Front/side mountable accessories
- Direct mountable overload relays available
- Degree of protection: IP20

Rating



MC-18a/4

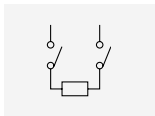

2pole for DC contact

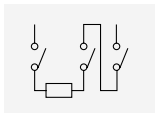

3pole for DC contact

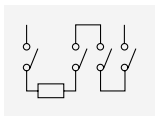

4pole for DC contact

| Contactor type | | | MC-6a/4 | | MC-9a/4 | | MC-12a/4 | | MC-18a/4 | |
|--|---------------------|-----------------|----------------------|----|---------|----|----------|----|----------|----|
| | | | kW | A | kW | A | kW | A | kW | A |
| AC duty | AC1 | 200/240V | 9 | 25 | 9 | 25 | 9 | 25 | 15 | 40 |
| | | 380/440V | 17 | 25 | 17 | 25 | 17 | 25 | 27 | 40 |
| | | 500/550V | 21 | 25 | 21 | 25 | 21 | 25 | 35 | 40 |
| | | 690V | 27 | 25 | 27 | 25 | 27 | 25 | 44 | 40 |
| | AC3 | 200/240V | 2.2 | 9 | 2.5 | 11 | 3.5 | 13 | 4.5 | 18 |
| | | 380/440V | 3 | 7 | 4 | 9 | 5.5 | 12 | 7.5 | 18 |
| | | lth | - | 25 | - | 25 | - | 25 | - | 40 |
| DC1 duty (L/R=1ms) | 2-pole in series | 110V | - | 6 | - | 6 | - | 10 | - | 13 |
| | | 220V | - | 3 | - | 3 | - | 7 | - | 8 |
| | 3-pole in series | 110V | - | 8 | - | 8 | - | 12 | - | 18 |
| | | 220V | - | 8 | - | 8 | - | 12 | - | 18 |
| | 4-pole in series | 110V | - | 10 | - | 10 | - | 15 | - | 20 |
| | | 220V | - | 10 | - | 10 | - | 12 | - | 20 |
| UL rating | | | hp | A | hp | A | hp | A | hp | A |
| 220/240V | | | 3 | - | 3 | - | 5 | - | 7.5 | - |
| 440/480V | | | 5 | - | 5 | - | 7.5 | - | 10 | - |
| 550/600V | | | 7.5 | - | 7.5 | - | 10 | - | 15 | - |
| lth | | | - | 25 | - | 25 | - | 25 | - | 32 |
| Conductor size (Solid, stranded) (The max. number of conducts: 2) | | AWG | 18~10 | | 18~10 | | 16~10 | | 16~8 | |
| | | mm ² | 1.5~4 | | 1.5~10 | | 1.5~10 | | 1~4 | |
| Conductor type | | | 65/75°C Cu-wire only | | | | | | | |



Coil voltage

| | | |
|----|---------|---|
| AC | 50Hz | 24, 32, 42, 48, 80, 100, 110, 220, 230, 240, 380, 400, 500, 550V |
| | 60Hz | 24, 48, 100, 110, 120, 200, 208, 220, 230, 240, 277, 380, 480, 600V |
| | 50/60Hz | 24, 48, 100, 110, 120, 200, 220, 230, 240, 380, 415, 440, 500, 550V |
| DC | | 12, 20, 24, 30, 48, 60, 80, 100, 110, 125, 200, 220, 250V |

Certification

- CE(IEC)
- UL508
- CCC

Accessories

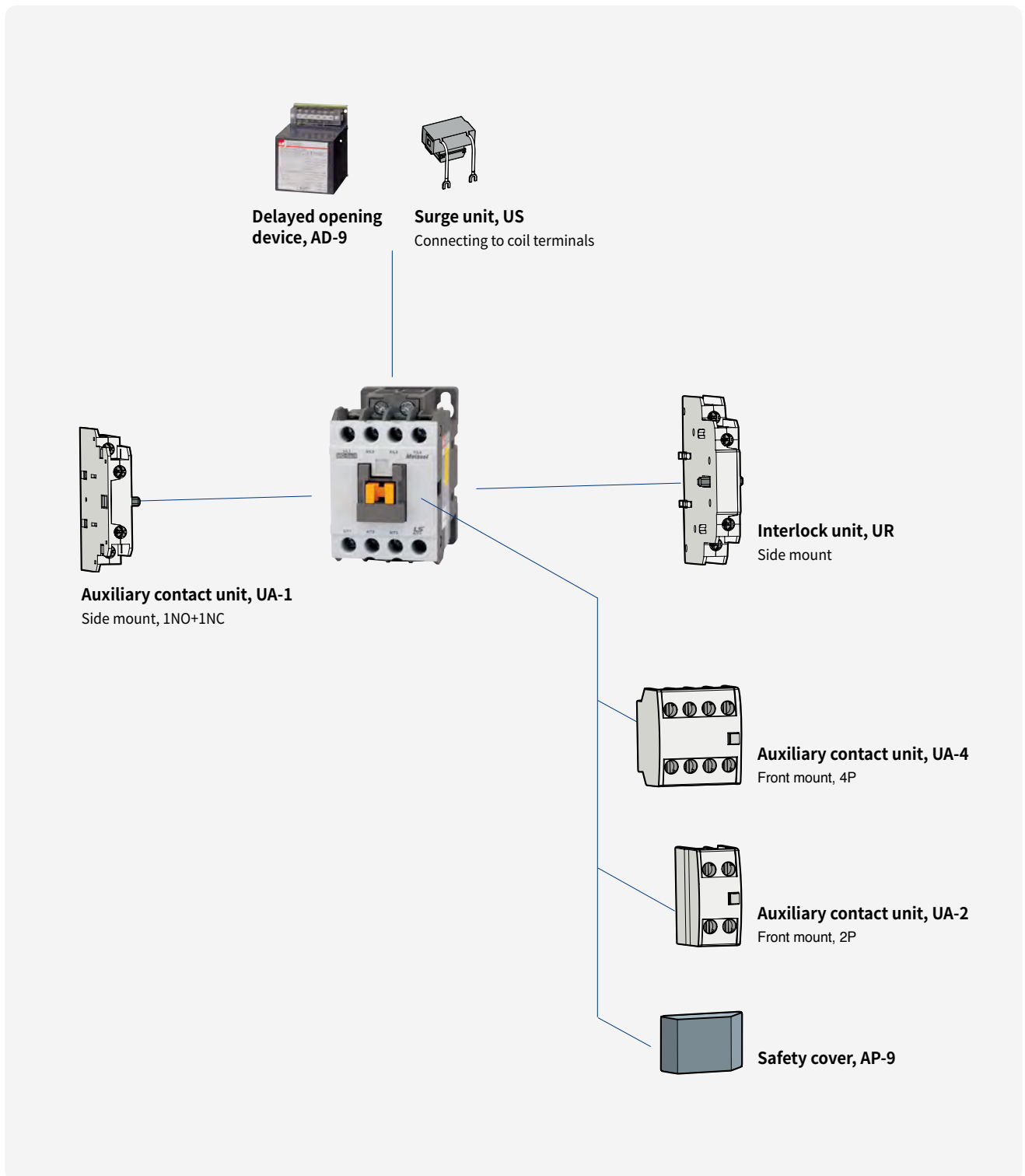

4-pole contactors

Description 22, 40AF

- 4-pole main contact
- Finger proof design
- DIN rail or screw mountable
- Auxiliary contacts are optional
- Front/side mountable accessories
- Direct mountable overload relays available
- Degree of protection: IP20

Rating

| Contactor type | | | MC-22a/4 | | MC-32a/4 | | MC-40a/4 | | |
|--|---------------------|-----------------|----------------------|----------|-----------|----------|-----------|----------|----|
| | | | kW | A | kW | A | kW | A | |
| AC duty | AC1 | 200/240V | 15 | 40 | 18 | 50 | 22 | 60 | |
| | | 380/440V | 27 | 40 | 35 | 50 | 42 | 60 | |
| | | 500/550V | 35 | 40 | 43 | 50 | 52 | 60 | |
| | | 690V | 44 | 40 | 55 | 50 | 66 | 60 | |
| | AC3 | 200/240V | 5.5 | 22 | 7.5 | 32 | 11 | 40 | |
| | | 380/440V | 11 | 22 | 15 | 32 | 18.5 | 40 | |
| | | lth | - | 40 | - | 50 | - | 60 | |
| DC1 duty (L/R=1ms) | 2-pole in series | 110V | - | 15 | - | 25 | - | 25 | |
| | | 220V | - | 10 | - | 12 | - | 12 | |
| | 3-pole in series | 110V | - | 20 | - | 25 | - | 35 | |
| | | 220V | - | 20 | - | 22 | - | 30 | |
| | 4-pole in series | 110V | - | 30 | - | 32 | - | 40 | |
| | | 220V | - | 25 | - | 30 | - | 35 | |
| UL rating | | | hp | A | hp | A | hp | A | |
| | | | 220/240V | 7.5 | - | 10 | - | 10 | - |
| | | | 440/480V | 10 | - | 20 | - | 25 | - |
| | | | 550/600V | 15 | - | 20 | - | 25 | - |
| | | | lth | - | 32 | - | 45 | - | 50 |
| Conductor size (Solid, stranded) (The max. number of conducts: 2) | | AWG | 12~8 | | 10~6 | | 8~6 | | |
| | | mm ² | 2.5~10 | | 4~16 | | 10~16 | | |
| Conductor type | | | 65/75°C Cu-wire only | | | | | | |



MC-22a/4



MC-40a/4

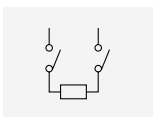

2pole for DC contact

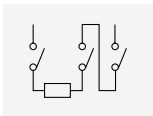

3pole for DC contact

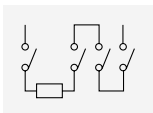

4pole for DC contact



Coil voltage

| | | |
|----|---------|---|
| AC | 50Hz | 24, 36, 42, 48, 65, 80, 100, 110, 220, 230, 240, 380, 400, 415, 440, 500, 550, 240(wide)V |
| | 60Hz | 24, 48, 110, 208, 220, 240, 277, 380, 440, 480, 600V |
| | 50/60Hz | 24, 48, 100, 110, 120, 200, 220, 230, 240, 380, 400, 415, 440, 500, 550V |
| DC | | 12, 20, 24, 48, 60, 80, 100, 110, 125, 200, 220, 250V |

Certification

- CE(IEC)
- UL508
- CCC

Accessories

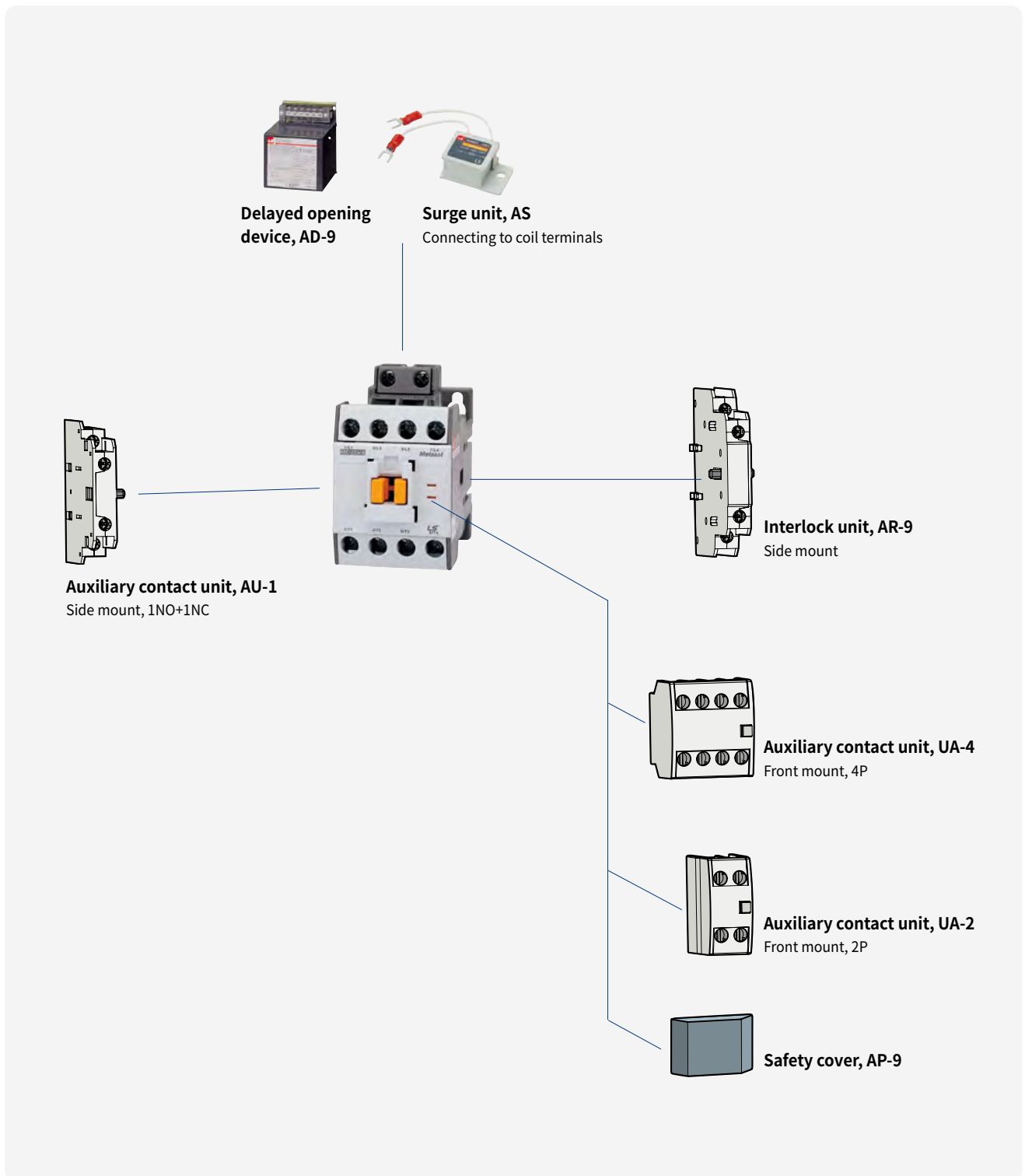

4-pole contactors

Description 85AF

- 4-pole main contact
- Finger proof design
- DIN rail or screw mountable
- Auxiliary contacts are optional
- Front/side mountable accessories
- Direct mountable overload relays available
- Degree of protection: IP20



MC-85a/4

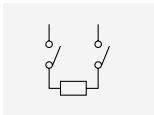

2pole for DC contact

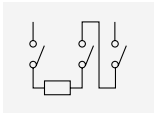

3pole for DC contact

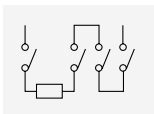

4pole for DC contact

Rating

| Contactor type | | | MC-50a/4 | | MC-65a/4 | | MC-75a/4 | | MC-85a/4 | |
|----------------------------------|---------------------|----------|----------------------|----------|-----------|----------|-----------|----------|-----------|----------|
| | | | kW | A | kW | A | kW | A | kW | A |
| AC duty | AC1 | 200/240V | 30 | 80 | 37 | 100 | 41 | 110 | 51 | 135 |
| | | 380/440V | 56 | 80 | 70 | 100 | 76 | 110 | 95 | 135 |
| | | 500/550V | 70 | 80 | 88 | 100 | 97 | 110 | 120 | 135 |
| | | 690V | 88 | 80 | 110 | 100 | 120 | 110 | 150 | 135 |
| | AC3 | 200/240V | 15 | 55 | 18.5 | 65 | 22 | 75 | 25 | 85 |
| | | 380/440V | 22 | 50 | 30 | 65 | 37 | 75 | 45 | 85 |
| | | lth | - | 80 | - | 100 | - | 110 | - | 135 |
| DC1 duty (L/R=1ms) | 2-pole in series | 110V | - | 35 | - | 35 | - | 50 | - | 50 |
| | | 220V | - | 15 | - | 15 | - | 20 | - | 20 |
| | 3-pole in series | 110V | - | 50 | - | 65 | - | 75 | - | 80 |
| | | 220V | - | 40 | - | 50 | - | 55 | - | 60 |
| | 4-pole in series | 110V | - | 60 | - | 70 | - | 80 | - | 100 |
| | | 220V | - | 50 | - | 60 | - | 70 | - | 70 |
| UL rating | | | hp | A | hp | A | hp | A | hp | A |
| | | | | | | | | | | |
| | | | | | | | | | | |
| | | | | | | | | | | |
| | | | | | | | | | | |
| Conductor size (Solid, stranded) | | | AWG | | 6~3 | | 4~2 | | 4~2 | |
| (The max. number of conducts: 2) | | | mm ² | | 16~35 | | 25~35 | | 25~50 | |
| Conductor type | | | 65/75°C Cu-wire only | | | | | | | |



Coil voltage

| | | |
|----|---------|--|
| AC | 50Hz | 24, 48, 100, 110, 200, 220, 230, 240, 380, 400, 415, 440, 500, 550V, 240(wide) |
| | 60Hz | 24, 48, 110, 120, 208, 220, 240, 277, 380, 440, 480, 600V |
| | 50/60Hz | 24, 48, 110, 120, 220, 230, 240, 380, 400, 415, 440, 500, 550V |
| DC | | 12, 20, 24, 48, 60, 80, 100, 110, 125, 200, 220, 250V |

Certification

- CE(IEC)
- UL508
- CCC

Note) For DC coil products in 85AF, 1a1b auxiliary contact is installed as standard. However, 1b contact is being used for coil control. Therefore, if necessary, only 1a contact can be used.

Accessories

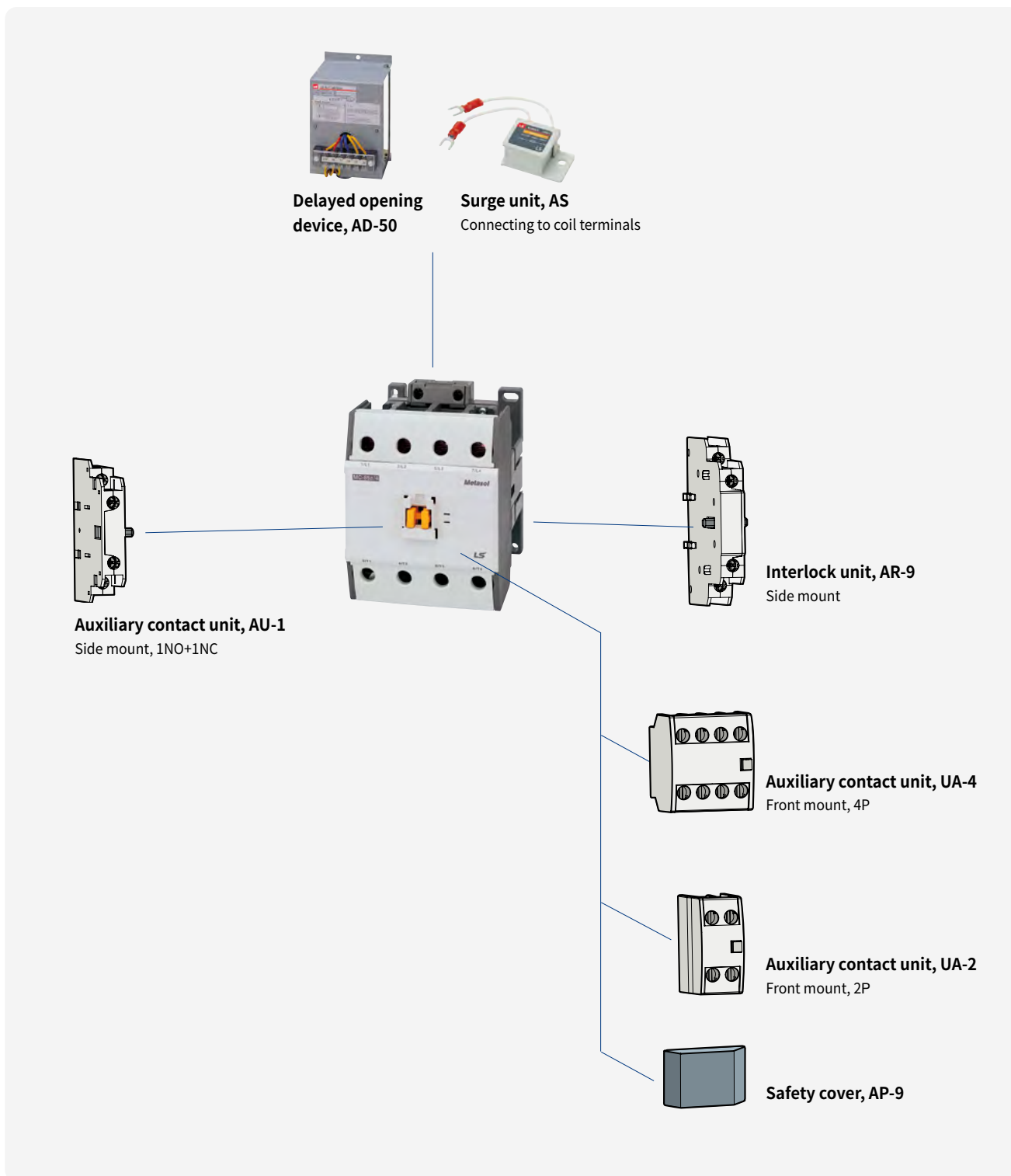

4-pole contactors

Description 225AF

- 4-pole main contact
- AC/DC common use coil built
- Wide coil operation voltage
- Screw mountable
- 2NO+2NC auxiliary contacts built-in as standard
- Side mountable accessories
- Direct mountable overload relays available
- Degree of protection: IP20



MC-225a/4

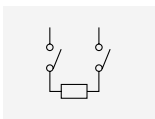

2pole for DC contact

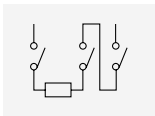

3pole for DC contact

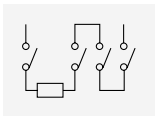

4-pole in series

Rating

| Contactor type | | | MC-100a/4 | | MC-130a/4 | | MC-150a/4 | | MC-185a/4 | | MC-225a/4 | | |
|----------------------------------|---------------------|-----------------------|-----------------------|----------|-----------|----------|-----------|----------|-----------|----------|-----------|----------|-----|
| | | | kW | A | kW | A | kW | A | kW | A | kW | A | |
| AC duty | AC1 | 200/240V | 57 | 200 | 60 | 250 | 76 | 275 | 87 | 300 | 100 | 350 | |
| | | 380/440V | 106 | 200 | 110 | 250 | 142 | 275 | 165 | 300 | 185 | 350 | |
| | | 500/550V | 132 | 200 | 137 | 250 | 180 | 275 | 205 | 300 | 230 | 350 | |
| | | 690V | 165 | 200 | 170 | 250 | 225 | 275 | 255 | 300 | 290 | 350 | |
| | AC3 | 200/240V | 30 | 105 | 37 | 125 | 45 | 150 | 55 | 185 | 75 | 225 | |
| | | 380/440V | 55 | 105 | 60 | 120 | 75 | 150 | 90 | 185 | 132 | 225 | |
| | | Ith | - | 200 | - | 250 | - | 275 | - | 300 | - | 350 | |
| | | 75°C Cu stranded wire | | | | | | | | | | | |
| DC1 duty (L/R=1ms) | 2-pole in series | 110V | - | 80 | - | 80 | - | 100 | - | 150 | - | 150 | |
| | | 220V | - | 50 | - | 50 | - | 100 | - | 150 | - | 150 | |
| | 3-pole in series | 110V | - | 100 | - | 100 | - | 150 | - | 180 | - | 220 | |
| | | 220V | - | 80 | - | 80 | - | 150 | - | 180 | - | 220 | |
| | 4-pole in series | 110V | - | 100 | - | 100 | - | 150 | - | 180 | - | 220 | |
| | | 220V | - | 90 | - | 100 | - | 150 | - | 180 | - | 220 | |
| UL rating | | | hp | A | hp | A | hp | A | hp | A | hp | A | |
| | | | 220/240V | 30 | - | 40 | - | 50 | - | 60 | - | 75 | - |
| | | | 440/480V | 60 | - | 75 | - | 100 | - | 125 | - | 150 | - |
| | | | 550/600V | 60 | - | 75 | - | 100 | - | 125 | - | 150 | - |
| | | | Ith | - | 200 | - | 250 | - | 275 | - | 300 | - | 350 |
| Conductor size (Solid, stranded) | | | AWG | 6~00 | 3~00 | 3~4/0 | 1~4/0 | 0~300 | | | | | |
| (The max. number of conducts: 2) | | | mm ² | 16~70 | 35~70 | 35~95 | 50~95 | 50~150 | | | | | |
| Conductor type | | | 75°C Cu stranded wire | | | | | | | | | | |



Coil voltage, AC/DC common

| Nominal(Ordering) voltage | AC 50/60Hz | DC |
|---------------------------|------------|------------|
| 24V | 24 - 25V | 24V |
| 48V | 48 - 50V | 48V |
| 100/200V | 100 - 240V | 100 - 220V |
| 300V | 265 - 347V | - |
| 400V | 380 - 450V | - |
| 500V | 440 - 575V | - |

Certification

- CE(IEC)
- UL508
- CCC

Accessories

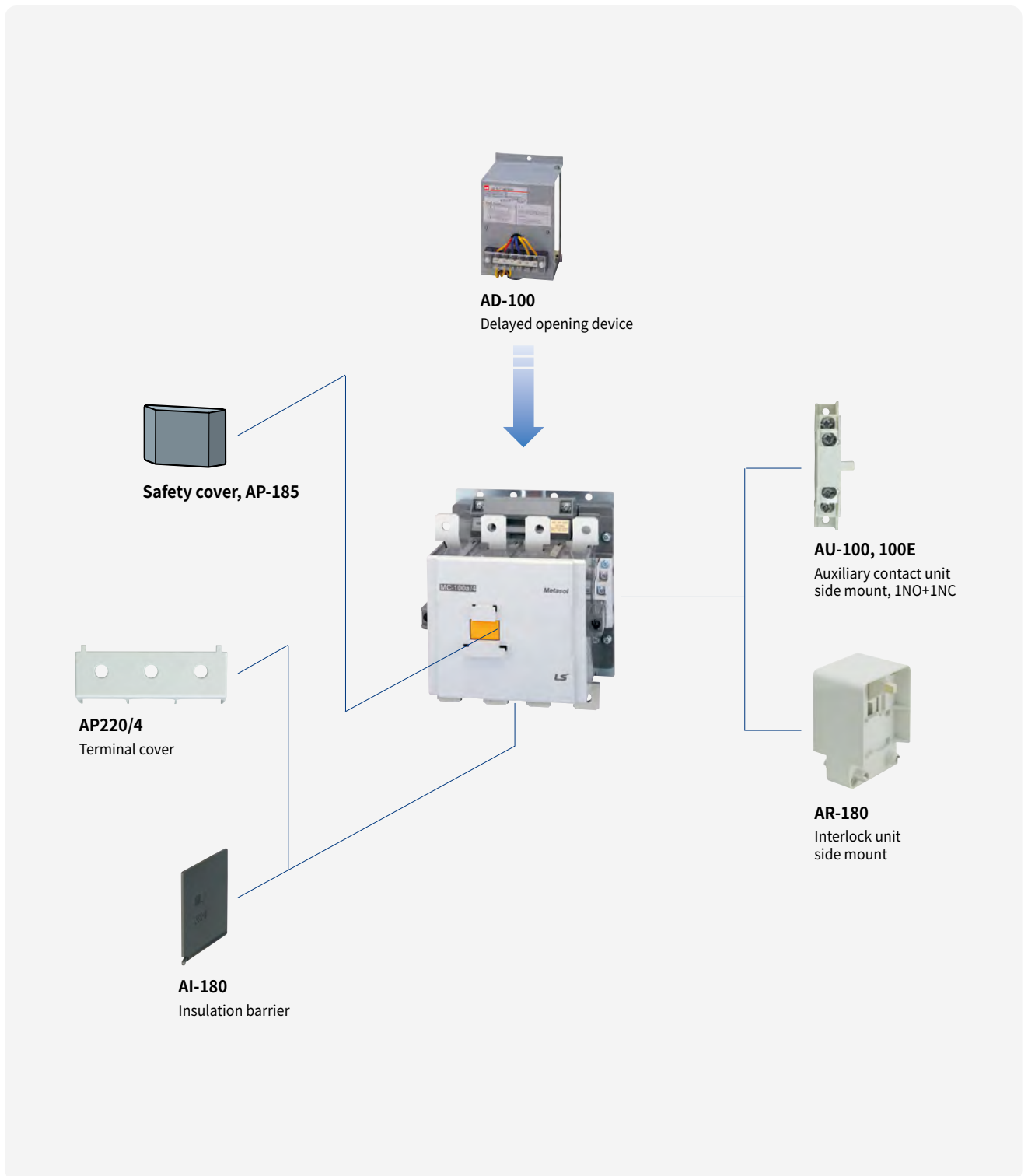

4-pole contactors

Description 400AF

- 4-pole main contact
- AC/DC common use coil built
- Wide coil operation voltage
- Screw mountable
- 2NO+2NC auxiliary contacts built-in as standard
- Side mountable accessories
- Degree of protection: IP20



MC-400a/4

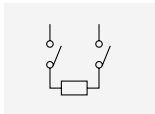

2pole for DC contact

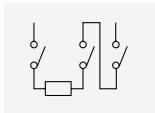

3pole for DC contact

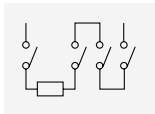

4pole for DC contact

Rating

| Contactor type | | | MC-265a/4 | | MC-330a/4 | | MC-400a/4 | | |
|--|---------------------|-----------------|-----------------------|----------|-----------|----------|-----------|----------|-----|
| | | | kW | A | kW | A | kW | A | |
| AC duty | AC1 | 200/240V | 115 | 400 | 135 | 500 | 160 | 520 | |
| | | 380/440V | 215 | 400 | 250 | 500 | 300 | 520 | |
| | | 500/550V | 265 | 400 | 315 | 500 | 375 | 520 | |
| | | 690V | 335 | 400 | 390 | 500 | 470 | 520 | |
| | AC3 | 200/240V | 80 | 265 | 90 | 330 | 125 | 400 | |
| | | 380/440V | 147 | 265 | 160 | 330 | 200 | 400 | |
| | | Ith | - | 400 | - | 500 | - | 520 | |
| DC1 duty (L/R=1ms) | 2-pole in series | 110V | - | 150 | - | 200 | - | 200 | |
| | | 220V | - | 150 | - | 200 | - | 200 | |
| | 3-pole in series | 110V | - | 220 | - | 300 | - | 400 | |
| | | 220V | - | 220 | - | 300 | - | 300 | |
| | 4-pole in series | 110V | - | 220 | - | 300 | - | 400 | |
| | | 220V | - | 220 | - | 300 | - | 300 | |
| UL rating | | | hp | A | hp | A | hp | A | |
| | | | 220/240V | 100 | - | 100 | - | 150 | - |
| | | | 440/480V | 200 | - | 200 | - | 300 | - |
| | | | 550/600V | 200 | - | 200 | - | 300 | - |
| | | | Ith | - | 400 | - | 500 | - | 520 |
| Conductor size (Solid, stranded) (The max. number of conducts: 2) | | AWG | 3/0~500 | | 4/0~500 | | 350~700 | | |
| | | mm ² | 95~240 | | 95~240 | | 185~370 | | |
| Conductor type | | | 75°C Cu stranded wire | | | | | | |



Coil voltage, AC/DC common

| Nominal(Ordering) voltage | AC 50/60Hz | DC |
|---------------------------|------------|------------|
| 100/200V | 100 - 240V | 100 - 220V |
| 300V | 265 - 347V | - |
| 400V | 380 - 450V | - |
| 500V | 440 - 575V | - |

| Certification |
|---|
| <ul style="list-style-type: none"> • CE(IEC) • UL508 • CCC |

Accessories

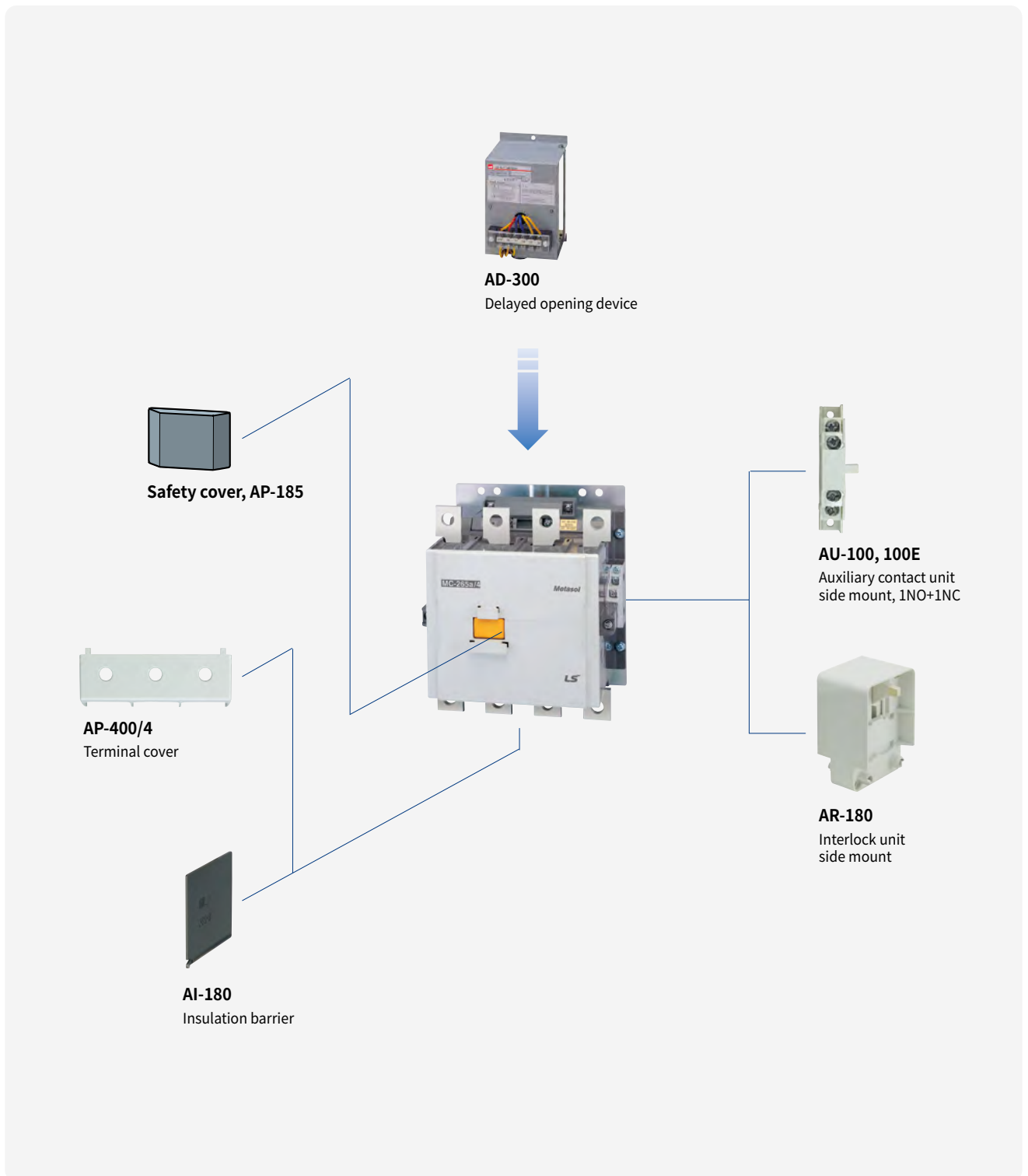

4-pole contactors

Description 800AF

- 4-pole main contact
- AC/DC common use coil built
- Wide coil operation voltage
- Screw mountable
- 2NO+2NC auxiliary contacts built-in as standard
- Side mountable accessories
- Degree of protection: IP20



MC-800a/4

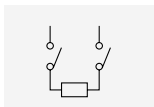

2pole for DC contact

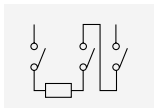

3pole for DC contact

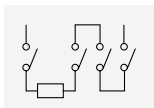

4pole for DC contact

Rating

| Contactor type | | | MC-500a/4 | | MC-630a/4 | | MC-800a/4 | | |
|--|------------------|-----------------|-----------------------|-----------|-----------|-----------|-------------|-----------|----------|
| | | | kW | A | kW | A | kW | A | |
| AC duty | AC1 | 200/240V | 245 | 700 | 255 | 900 | 310 | 1050 | |
| | | 380/440V | 450 | 700 | 470 | 900 | 570 | 1050 | |
| | | 500/550V | 560 | 700 | 590 | 900 | 710 | 1050 | |
| | | 690V | 710 | 700 | 740 | 900 | 900 | 1050 | |
| | AC3 | 200/240V | 147 | 500 | 190 | 630 | 220 | 800 | |
| | | 380/440V | 265 | 500 | 330 | 630 | 440 | 800 | |
| | | Ith | - | 700 | - | 900 | - | 1050 | |
| | | | | | | | | | |
| DC1 duty (L/R=1ms) | 2-pole | 110V | - | 200 | - | 630 | - | 630 | |
| | | 220V | - | 200 | - | 630 | - | 630 | |
| | 3-pole | 110V | - | 400 | - | 630 | - | 800 | |
| | | 220V | - | 300 | - | 630 | - | 800 | |
| | 4-pole | 110V | - | 400 | - | 630 | - | 800 | |
| | | 220V | - | 300 | - | 630 | - | 800 | |
| | UL rating | | | hp | A | hp | A | hp | A |
| | | 220/240V | 200 | - | 250 | - | 300 | - | |
| | 440/480V | 400 | - | 500 | - | 600 | - | | |
| | 550/600V | 400 | - | 500 | - | 600 | - | | |
| | Ith | - | 700 | - | 900 | - | 1050 | | |
| Conductor size (Solid, stranded) (The max. number of conducts: 2) | | AWG | 350~800 | | 600~2000 | | 1700~Busbar | | |
| | | mm ² | 185~480 | | - | | - | | |
| Conductor type | | | 75°C Cu stranded wire | | | | | | |



Coil voltage, AC/DC common

| Nominal(Ordering) voltage | AC 50/60Hz | DC |
|---------------------------|------------|------------|
| 100V | 100 - 127V | 100 - 220V |
| 200V | 200 - 240V | 200 - 220V |
| 300V | 265 - 347V | - |
| 400V | 380 - 450V | - |
| 500V | 440 - 575V | - |

Certification

- CE(IEC)
- UL508
- CCC

Accessories

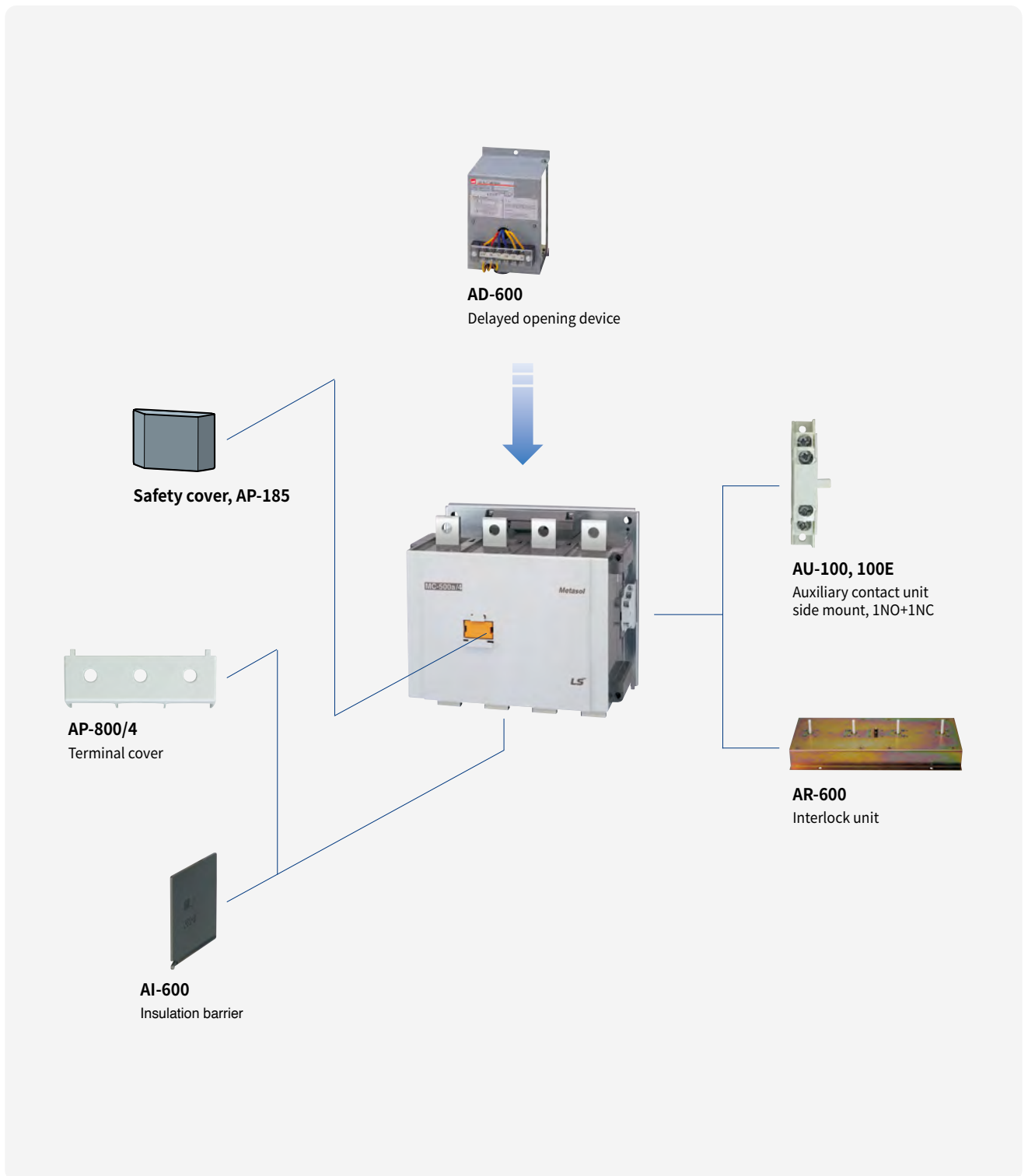

Enclosed motor starters, Mold enclosure

Description

- Enclosed & full voltage type
 - MW-□bM: Plastic enclosure without buttons
 - MW-□bMB: Plastic enclosure with ON/OFF buttons
- With differential or non-differential type thermal overload relay
- Contactors: 3 pole with AC coil
- Screw mountable
- Degree of protection: IP40

Rating



| Type | AC3 Ratings (IEC 60947-4-1) | | | | Auxiliary contact (standard) | Devices combined | |
|------------|-----------------------------|-----------|-----------|----------|------------------------------|------------------|-----------------|
| | 220~240V | 380~440V | 500~550V | 690V | | Contactor | Overload relay |
| MW-9bM(B) | 2.5kW 11A | 4kW 9A | 4kW 7A | 4kW 6A | 1NO1NC | MC-9b | MT-32 (0.1-22A) |
| MW-12bM(B) | 3.5kW 13A | 5.5kW 12A | 7.5kW 12A | 7.5kW 9A | | MC-12b | |
| MW-18bM(B) | 4.5kW 18A | 7.5kW 18A | 7.5kW 13A | 7.5kW 9A | | MC-18b | |
| MW-22bM(B) | 5.5kW 22A | 11kW 22A | 15kW 20A | 15kW 18A | | MC-22b | |



Overload relay setting range, Amp.

| MT-12 | | MT-32 | | MT-63 | | MT-95 | |
|-------------|---------|-------------|---------|---------|---------|---------|----------|
| 0.1 - 0.16 | 5 - 8 | 0.1 - 0.16 | 5 - 8 | 4 - 6 | 28 - 40 | 7 - 10 | 54 - 75 |
| 0.16 - 0.25 | 6 - 9 | 0.16 - 0.25 | 6 - 9 | 5 - 8 | 34 - 50 | 9 - 13 | 63 - 85 |
| 0.25 - 0.4 | 7 - 10 | 0.25 - 0.4 | 7 - 10 | 6 - 9 | 45 - 65 | 12 - 18 | 70 - 95 |
| 0.4 - 0.63 | 9 - 13 | 0.4 - 0.63 | 9 - 13 | 7 - 10 | | 16 - 22 | 80 - 100 |
| 0.63 - 1 | 12 - 18 | 0.63 - 1 | 12 - 18 | 9 - 13 | | 18 - 25 | |
| 1 - 1.6 | | 1 - 1.6 | 16 - 22 | 12 - 18 | | 24 - 36 | |
| 1.6 - 2.5 | | 1.6 - 2.5 | 18 - 25 | 16 - 22 | | 28 - 40 | |
| 2.5 - 4 | | 2.5 - 4 | 22 - 32 | 18 - 25 | | 34 - 50 | |
| 4 - 6 | | 4 - 6 | 28 - 40 | 24 - 36 | | 45 - 65 | |



Internal device



Coil voltage

| AC | 50Hz | 60Hz |
|----|--|---|
| | 24, 32, 42, 48, 80, 100, 110, 220, 230, 240, 380, 400, 500, 550V | 24, 48, 100, 110, 120, 200, 208, 220, 230, 240, 277, 380, 480, 600V |

| Certification |
|-------------------|
| • CE(IEC) • UL508 |

Type numbering system

| MW-6a | / | B | / | 2H |
|----------------------|---|---|---|---------------------------------------|
| Rated current | | Enclosure type | | Thermal overload relay version |
| 6a 6A | | - Without push button (Steel enclosure) | | 2H Non-differential(2-heater) |
| ⋮ | | B With push button (Steel enclosure) | | 3H Non-differential(3-heater) |
| 100a 100A | | M Without push button (Mold enclosure) | | 3K Differential |
| | | MB With push button (Mold enclosure) | | 3D Class 20 |

Description

- Full voltage type
MW-□a/MW-□b: Steel enclosure without buttons
MW-□aB/MW-□bB: Steel enclosure ON/OFF buttons
- Contactors: 3 pole with AC coil
- Overload relay with differential or non-differential type
- Screw mountable
- Degree of protection: IP40

Rating



Internal device

| Type | AC3 Ratings (IEC 60947-4-1) | | | | | Devices combined | |
|------------|-----------------------------|------------|------------|------------|----------|------------------|--------------------|
| | 220~240V | 380~440V | 500~550V | 690V | 1000V | Contactor | Overload relay |
| MW-6a(B) | 2.2kW 9A | 3kW 7A | 3kW 6A | 3kW 4A | - | MC-6a | MT-12 (0.1~18A) |
| MW-9a(B) | 2.5kW 11A | 4kW 9A | 4kW 7A | 4kW 5A | - | MC-9a | |
| MW-12a(B) | 3.5kW 13A | 5.5kW 12A | 7.5kW 12A | 7.5kW 9A | - | MC-12a | |
| MW-18a(B) | 4.5kW 18A | 7.5kW 18A | 7.5kW 13A | 7.5kW 9A | - | MC-18a | MT-32 (0.1~22A) |
| MW-9b(B) | 2.5kW 11A | 4kW 9A | 4kW 7A | 4kW 6A | - | MC-9b | |
| MW-12b(B) | 3.5kW 13A | 5.5kW 12A | 7.5kW 12A | 7.5kW 9A | - | MC-12b | |
| MW-18b(B) | 4.5kW 18A | 7.5kW 18A | 7.5kW 13A | 7.5kW 9A | - | MC-18b | MT-32 (0.1~40A) |
| MW-22b(B) | 5.5kW 22A | 11kW 22A | 15kW 20A | 15kW 18A | - | MC-22b | |
| MW-32a(B) | 7.5kW 32A | 15kW 32A | 18.5kW 28A | 18.5kW 20A | 22kW 17A | MC-32a | |
| MW-40a(B) | 11kW 40A | 18.5kW 40A | 22kW 32A | 22kW 23A | 22kW 17A | MC-40a | MT-63 (4~65A) |
| MW-50a(B) | 15kW 55A | 22kW 50A | 30kW 43A | 30kW 28A | 30kW 23A | MC-50a | |
| MW-65a(B) | 18.5kW 65A | 30kW 65A | 33kW 60A | 33kW 35A | 30kW 23A | MC-65a | |
| MW-75a(B) | 22kW 75A | 37kW 75A | 37kW 64A | 37kW 42A | 37kW 28A | MC-75a | MT-95 (7~100A) |
| MW-85a(B) | 25kW 85A | 45kW 85A | 45kW 75A | 45kW 45A | 37kW 28A | MC-85a | |
| MW-100a(B) | 30kW 105A | 55kW 105A | 55kW 85A | 55kW 65A | 37kW 28A | MC-100a | |

Overload relay setting range, Amp.

| MT-12 | | MT-32 | | MT-63 | | MT-95 | |
|-------------|---------|-------------|---------|---------|---------|---------|----------|
| 0.1 - 0.16 | 5 - 8 | 0.1 - 0.16 | 5 - 8 | 4 - 6 | 28 - 40 | 7 - 10 | 54 - 75 |
| 0.16 - 0.25 | 6 - 9 | 0.16 - 0.25 | 6 - 9 | 5 - 8 | 34 - 50 | 9 - 13 | 63 - 85 |
| 0.25 - 0.4 | 7 - 10 | 0.25 - 0.4 | 7 - 10 | 6 - 9 | 45 - 65 | 12 - 18 | 70 - 95 |
| 0.4 - 0.63 | 9 - 13 | 0.4 - 0.63 | 9 - 13 | 7 - 10 | | 16 - 22 | 80 - 100 |
| 0.63 - 1 | 12 - 18 | 0.63 - 1 | 12 - 18 | 9 - 13 | | 18 - 25 | |
| 1 - 1.6 | | 1 - 1.6 | 16 - 22 | 12 - 18 | | 24 - 36 | |
| 1.6 - 2.5 | | 1.6 - 2.5 | 18 - 25 | 16 - 22 | | 28 - 40 | |
| 2.5 - 4 | | 2.5 - 4 | 22 - 32 | 18 - 25 | | 34 - 50 | |
| 4 - 6 | | 4 - 6 | 28 - 40 | 24 - 36 | | 45 - 65 | |



Coil voltage

| AC | 50Hz | 24, 32, 42, 48, 80, 100, 110, 220, 230, 240, 380, 400, 500, 550V |
|----|------|---|
| | 60Hz | 24, 48, 100, 110, 120, 200, 208, 220, 230, 240, 277, 380, 480, 600V |

| Certification |
|-------------------|
| • CE(IEC) • UL508 |

Capacitor contactors

Description

- Capacitor unit (Pre-loading resistor) is connected to the terminals of the contactor to reduce the high inrush current exceeding $20 \times I_n$.
- AC control coil on selection
- 3-pole (NO) main contact
- Finger proof design
- DIN rail or screw mountable
- IEC 60947-4-1 AC 6b

Rating

| Type | Rating (kVar, A) | | | |
|--------------------|------------------|----------|----------|----------|
| | 220~240V | 400~440V | 500~550V | 600~690V |
| MC-9b with AC-9 | 5kVar | 9.7kVar | 14kVar | 16kVar |
| | 13A | 14A | 16A | 15A |
| MC-12b with AC-9 | 6.7kVar | 12.5kVar | 18kVar | 18kVar |
| | 18A | 18A | 21A | 17A |
| MC-18b with AC-9 | 8.5kVar | 16.7kVar | 24kVar | 26kVar |
| | 22A | 24A | 28A | 25A |
| MC-22b with AC-9 | 10kVar | 18kVar | 26kVar | 30kVar |
| | 26A | 26A | 30A | 29A |
| MC-32a with AC-9 | 15kVar | 25kVar | 36kVar | 40kVar |
| | 39A | 36A | 42A | 38A |
| MC-40a with AC-9 | 20kVar | 33.3kVar | 48kVar | 53kVar |
| | 52A | 48A | 55A | 51A |
| MC-50a with AC-50 | 20kVar | 40kVar | 58kVar | 65kVar |
| | 52A | 58A | 67A | 63A |
| MC-65a with AC-50 | 25kVar | 45.7kVar | 66kVar | 73kVar |
| | 66A | 66A | 76A | 70A |
| MC-75a with AC-75 | 29.7kVar | 54kVar | 78kVar | 85kVar |
| | 78A | 78A | 90A | 82A |
| MC-85a with AC-75 | 35kVar | 60kVar | 92kVar | 100kVar |
| | 92A | 87A | 106A | 96A |
| MC-100a with AC-75 | 37kVar | 62kVar | 94kVar | 105kVar |
| | 97A | 89A | 109A | 101A |

| Type | Rating (kVar, A) | |
|---------|------------------|----------|
| | 500~550V | 600~690V |
| MC-9b | 4kVar | 3.5kVar |
| | 4.6A | 3.4A |
| MC-12b | 4kVar | 4kVar |
| | 4.6A | 3.8A |
| MC-18b | 5kVar | 4.5kVar |
| | 5.8A | 4.3A |
| MC-22b | 8kVar | 8kVar |
| | 9.2A | 7.7A |
| MC-32a | 17kVar | 14kVar |
| | 20A | 13A |
| MC-40a | 25kVar | 18kVar |
| | 29A | 17A |
| MC-50a | 30kVar | 25kVar |
| | 35A | 24A |
| MC-65a | 40kVar | 35kVar |
| | 46A | 34A |
| MC-75a | 50kVar | 40kVar |
| | 58A | 38A |
| MC-85a | 55kVar | 45kVar |
| | 64A | 43A |
| MC-100a | 60kVar | 48kVar |
| | 69A | 46A |
| MC-130a | 70kVar | 60kVar |
| | 81A | 58A |
| MC-150a | 90kVar | 78kVar |
| | 104A | 75A |
| MC-185a | 120kVar | 100kVar |
| | 139A | 96A |
| MC-225a | 130kVar | 105kVar |
| | 150A | 101A |
| MC-265a | 140kVar | 115kVar |
| | 162A | 111A |
| MC-330a | 185kVar | 140kVar |
| | 214A | 135A |
| MC-400a | 195kVar | 160kVar |
| | 225A | 154A |
| MC-500a | 330kVar | 290kVar |
| | 381A | 279A |
| MC-630a | 340kVar | 300kVar |
| | 393A | 289A |
| MC-800a | 370kVar | 320kVar |
| | 427A | 308A |

- Note) 1. When the switch is closed condenser must be discharged before recharged. (Maximum residual voltage at terminals $\leq 50V$)
 2. To prevent short current, gG type fuse must be 1.5-2 times than rated current.



Coil voltage

| AC | 50Hz | 24, 32, 42, 48, 80, 100, 110, 220, 230, 240, 380, 400, 500, 550V |
|----|------|---|
| | 60Hz | 24, 48, 100, 110, 120, 200, 208, 220, 230, 240, 277, 380, 480, 600V |

- These capacitive contactors are suitable for switching single-step or multiple-step condenser bank.
- It is standardized by IEC-60947-4941, UL and CSA.
- Features of capacitor unit (Pre-loading resistor)
 - Damping resistor that can limit the inrush current upto $60 \times I_n$ is connected to the mechanism that closed earlier than the main contact of the contactor
 - No heat loss by the serial resistor
 - Eliminate the switching surge
 - Improving the performance of the capacitor system

Example

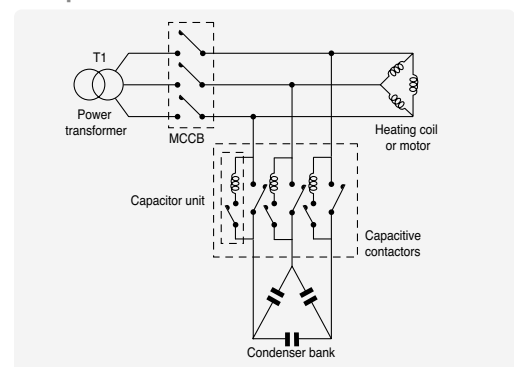

Description

- Two normally open main contacts
- Screw clamp or fast-on connections
- Small and light design suitable for use in air conditioners, heaters, refrigerators, etc.
- Screw mountable
- No auxiliary contact
- AC control voltage

Rating

| Type | AC3 ratings | | | I _{th} | Contact | |
|----------|-------------|----------|----------|-----------------|---------|----|
| | 220~240V | 380~440V | 500~550V | | NO | NC |
| GMC-10P2 | 10A | 8A | 6A | 20A | 2 | - |
| GMC-20P2 | 20A | 17A | 14A | 30A | 2 | - |
| GMC-25P2 | 25A | 21A | 17A | 35A | 2 | - |
| GMC-30P2 | 30A | 23A | 21A | 40A | 2 | - |
| GMC-35P2 | 35A | 26A | 23A | 45A | 2 | - |
| GMC-40P2 | 40A | 32A | 26A | 50A | 2 | - |

Insulation voltage: 690V at AC, 250V at DC

Control coil characteristics

| Coil voltage | Coil consumption (VA) | | Thermal dissipation (W) | Operational voltage (V) | | Coil current (mA) | Operational time (ms) | |
|--------------|-----------------------|---------|-------------------------|-----------------------------|-------------------------------|-------------------|-----------------------|---------|
| | Inrush | Holding | | Pick-up | Drop-out | | Closing | Opening |
| 24V 50/60Hz | 35 | 6.0 | 2 | 83% or less of coil voltage | More than 20% of coil voltage | 263 | 40 | 30 |
| 48V 50/60Hz | 35 | 6.0 | 2 | | | 131 | 40 | 30 |
| 100V 50/60Hz | 35 | 6.0 | 2 | | | 63 | 40 | 30 |
| 110V 50/60Hz | 35 | 6.0 | 2 | | | 57 | 40 | 30 |
| 120V 50/60Hz | 35 | 6.0 | 2 | | | 53 | 40 | 30 |
| 200V 50/60Hz | 35 | 6.0 | 2 | | | 32 | 40 | 30 |
| 220V 50/60Hz | 35 | 6.0 | 2 | | | 29 | 40 | 30 |
| 230V 50/60Hz | 35 | 6.0 | 2 | | | 27 | 40 | 30 |
| 240V 50/60Hz | 35 | 6.0 | 2 | | | 26 | 40 | 30 |

Note) 1. The condition of the above data: 60Hz, 20°C from cold state

2. Coil consumption (VA) is average value.



Main terminal

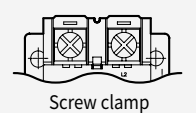

Screw clamp

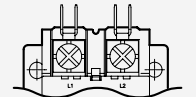

Fast-on (Quick connect)

Coil terminal

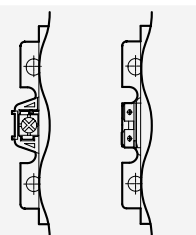

Screw clamp

Fast-on (Quick connect)

Type numbering system

| GMC | 10P | 2 | TS | BQ | 100V |
|------------|--------------|---------|-----------------------|----------------------|------------------------|
| Contactors | Capacity (A) | Pole | Main terminal connect | Power supply connect | Operation voltage (AC) |
| | 10P 10 | 2 2pole | TS Screw clamp | BS Screw clamp | 20V 24V |
| | 20P 20 | | TQ Quick connect | BQ Quick connect | 48V 24~240 |
| | 25P 25 | | | | 110V 100~120V |
| | 30P 30 | | | | 220V 208~240V |
| | 35P 35 | | | | |
| | 40P 40 | | | | |

3-pole AC contactors, Definite purpose

Description

- Three main contacts
- Screw clamp connections
- Small and light design suitable for use in air conditioners, heaters, refrigerators, etc.
- Screw mountable
- No auxiliary contact
- AC control voltage



Rating

| Type | AC3 ratings | | | AC4 ratings | | | Ith | Contact | |
|----------------------|-------------|----------|----------|-------------|----------|----------|-----|---------|----|
| | 220~240V | 380~440V | 500~550V | 220~240V | 380~440V | 500~550V | | NO | NC |
| GMC-20D2 GMC-20D3 | 20A | 17A | 14A | 18A | 13A | 10A | 30A | 2 | - |
| | | | | | | | | 3 | - |
| | | | | | | | | 2 | 1 |
| GMC-25D2 GMC-25D3 | 25A | 21A | 17A | 20A | 14A | 12A | 35A | 2 | - |
| | | | | | | | | 3 | - |
| | | | | | | | | 2 | 1 |

Note) Above contact ratings are for NO contact.
 Rating for NC contact: 6A@120V, 3A@240V, 1.5A@480V at AC15 duty
 Rating above 24V 1A
 Please use NC contact for Insulation voltage: 690V at AC, 250V at DC

Control coil characteristics

| Coil voltage | Coil consumption (VA) | | Thermal dissipation (W) | Operational voltage(V) | | Coil current (mA) | Operational time (ms) | |
|--------------|-----------------------|---------|-------------------------|-----------------------------|-------------------------------|-------------------|-----------------------|---------|
| | Inrush | Holding | | Pick-up | Drop-out | | Closing | Opening |
| 24V 60Hz | 72 | 9.0 | 3 | 83% or less of coil voltage | More than 20% of coil voltage | 215 | 30 | 20 |
| 48V 60Hz | 72 | 9.0 | 3 | | | 125 | 30 | 20 |
| 110V 60Hz | 72 | 9.0 | 3 | | | 60 | 30 | 20 |
| 220V 60Hz | 72 | 9.0 | 3 | | | 41 | 30 | 20 |

Note) 1. The condition of the above data: 60Hz, 20°C from cold state
 2. Coil consumption (VA) is average value.

Type numbering system

| GMC | / | 20 | D2 | 2NO1NC | AC 220V |
|------------|---|---------------|------|-------------------|------------------------|
| Contactors | | Rated current | Pole | Auxiliary contact | Operation voltage (AC) |
| | | 20 | D2 | 2pole: 2NO | 20V |
| | | 25 | D3 | 3pole: 3NO | 48V |
| | | | | 2NO 1NC | 110V |
| | | | | 2NO1NC | 220V |

Description

- Single-pole NO main contact
- Small and light design suitable for use in electric shock protector for AC arc welder
- DIN rail or screw mountable
- No auxiliary contact (Optional unit can be added up to 2NO2NC)
- AC control voltage



Rating

| Type | Rated current, In 110/220V | Ith | Performance | |
|----------|-------------------------------|------|----------------|------------------|
| | | | Making current | Breaking current |
| MC-65aSP | 220A | 500A | 1.5×In | |

Control coil characteristics

| Coil consumption (VA) | | Operational voltage | | Operational time |
|-----------------------|---------|---------------------|----------|------------------|
| Inrush | Holding | Pick-up | Drop-out | Closing |
| 150VA | 17VA | 85% under | 20% over | 30ms under |

Note) Coil voltage is available between AC24V and AC550V

2-pole DC contactors

Description

- Two normally open main contacts for DC circuit
- Positive and negative poles indicated on the front plate
- Eternal magnet installed for the effective arc extinguishing
- DIN rail or screw mountable
- 2NO+2NC Auxiliary contacts built-in as standard
- AC/DC control voltage
- Durability : 500K times(Elec.) / 10M times(Mech.)



Selection

| Contactor Type | DC-3, 5 ratings | | | DC-1 rating | Continuous current, Ith | Auxiliary contacts |
|----------------|-----------------|------|------|-------------|-------------------------|--------------------|
| | 125V | 250V | 500V | 1000V | | |
| MD-30a | 40A | 30A | 20A | 10A | 60A | 2a(NO)+2b(NC) |
| MD-60a | 80A | 60A | 40A | 25A | 100A | 2a(NO)+2b(NC) |
| MD-100a | 120A | 100A | 60A | 35A | 135A | 2a(NO)+2b(NC) |



Ratings of auxiliary contacts

| UA-1 | AC15 duty | | | | | | DC13 duty | | | | |
|-------------------------|-----------|------|------|------|------|------|-----------|-------|-------|------|------|
| | 120V | 240V | 380V | 480V | 500V | 600V | 125V | 250V | 400V | 500V | 600V |
| Rated currents | 6A | 3A | 1.9A | 1.5A | 1.4A | 1.2A | 1.1A | 0.55A | 0.31A | 0.27 | 0.2A |
| Continuous current, Ith | 16A | | | | | | | | | | |



Coil voltage

| | | |
|----|---------|--|
| AC | 50/60Hz | 24, 48, 100, 110, 120, 200, 220, 230, 240, 380, 400, 415, 440, 500, 550V |
| DC | | 12, 20, 24, 48, 60, 80, 100, 110, 125, 200, 220, 250V |

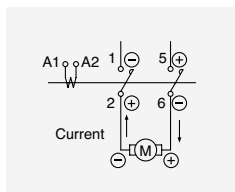

Auxiliary contact units

- 2 and 4 pole
- Side and front mountable
- Common use for Metasol contactors from MC-6a to MC-150a, and from MC-6a/4 to 85a/4
- Auxiliary contact meet the requirements for mirror contacts in IEC 60947-4-1. Annex F (A mirror contact is an auxiliary NC contact that cannot be closed simultaneously with a NO main contact)

MC-6a~MC-150a
MC-6a/4~85a/4

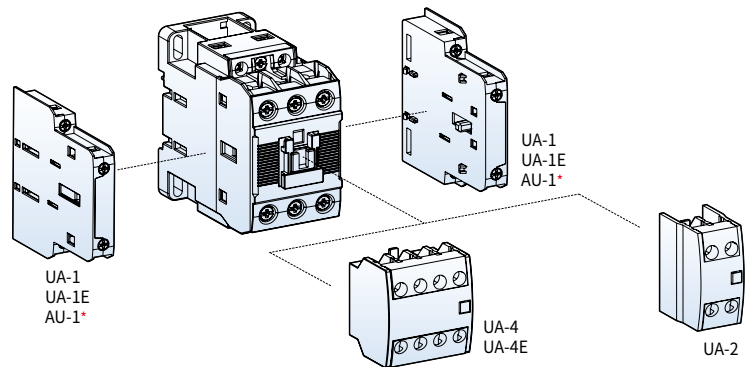

* AU-1 only applies to MC-22a/4~85a/4.

Selection

| Type | Appearance | Pole | Composition | | Contact arrangement | Mount | Weight |
|-----------------------|------------|------|-----------------------|-----------------------|---------------------|-------|--------|
| | | | No | Nc | | | |
| UA-1 UA-1E AU-1 | | 2 | 1 | 1 | | Side | 53g |
| UA-2 | | 2 | 2 1 - | - 1 2 | | Front | 28g |
| UA-4 UA-4E | | 4 | 4 3 2 1 - | - 1 2 3 4 | | Front | 50g |

* UA-1 auxiliary contact can not be attached to the right side of 22AF product

Maximum combination of contact units

| MC-6a~18a, 9b~22b (Max. 3a3b) | MC-32a~150a (Max. 4a4b) |
|---|---|
| UA-4(2a2b)+UA-1×1EA (1EA on one side) | UA-4(2a2b)+UA-1×2EA (1EA on both sides) |
| UA-2(2a, 1a, 1b, 2b)+UA-1×1EA (1EA on one side) | UA-2(2a, 1a, 1b, 2b)+UA-1×2EA (1EA on both sides) |
| UA-1×2EA (1EA on both sides) | UA-1×4EA (2EA on both sides) *For AC Coil |

* Max. 2a2b can be attached for MC-6a-18a & 9b-22b DC type.
 - UA-4(2a2b) 1EA
 - UA-2(2a, 1a, 1b, 2b) 1EA
 - UA-2(1a1b) 1EA + UA-1 1EA
 - UA-1 1EA

Auxiliary contact units

- 2 pole
- Side mountable
- Auxiliary contact meet the requirements for mirror contacts in IEC 60947-4-1. Annex F
(A mirror contact is an auxiliary NC contact that cannot be closed simultaneously with a NO main contact)



Selection

| Type | Appearance | Pole | Composition | | Contact arrangement | Mount | Weight |
|-------------------|------------|------|-------------|-------|---------------------|-------|--------|
| | | | a(NO) | b(NC) | | | |
| AU-100 AU-100E | | 2 | 1 | 1 | | Side | 53g |

Maximum combination of contact units

MC-185a~2650a (Max. 4a4b)

AU-100 × 4EA (2EA on both sides)

AU-100E × 4EA (2EA on both sides)

Installation

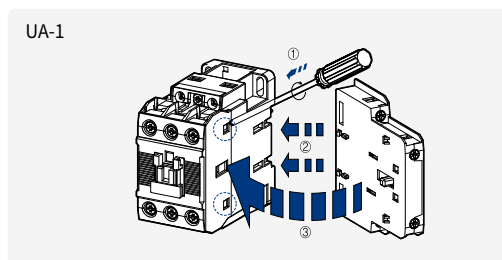

To install side mounting unit remove the indicated part in the circle in the fig. first. And then fit each part as shown. To separate push forward and pull.

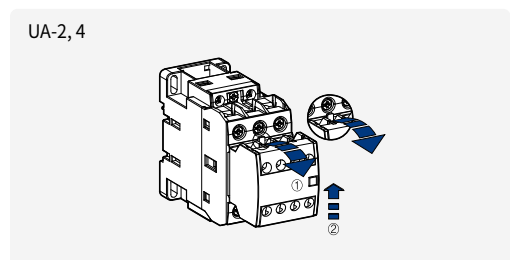

To install front mounting unit fit it on the upper part of the front of the contactor and push it down. To separate pull the lever of the unit and push the unit upward.

Rating

| Type | | UA-1 | AU-1 | UA-2, 4 | AU-100 |
|--|---|---------|---------|---------|---------|
| Rated operation voltage | (Ue) | 600V | 600V | 600V | 600V |
| Rated insulation voltage | (Ui) | 1000V | 690V | 690V | 600V |
| Rated impulse withstand voltage | (Uimp) | 8kV | 8kV | 6kV | 6kV |
| Rated frequency | | 50/60Hz | 50/60Hz | 50/60Hz | 50/60Hz |
| Contact sensibility | Voltage | DC 24V | DC 24V | DC 24V | DC 24V |
| | Current | DC 10mA | DC 10mA | DC 10mA | DC 10mA |
| Rated thermal current (Ith, AC12 duty) | | 16A | 16A | 16A | 16A |
| Rated operation current | AC15 duty | 120V | 6A | 6A | 6A |
| | | 240V | 3A | 3A | 3A |
| | | 380V | 1.9A | 1.9A | 1.9A |
| | | 480V | 1.5A | 1.5A | 1.5A |
| | | 500V | 1.4A | 1.4A | 1.4A |
| | | 600V | 1.2A | 1.2A | 1.2A |
| Rated | 1s | 100A | 100A | - | 100A |
| Short-time withstand current | 0.5s | 125A | 125A | - | 120A |
| | 0.1s | 145A | 145A | - | 140A |
| Electrical lifetime (Mil. operations) | AC15 duty | 220V | 0.25 | 0.25 | 0.25 |
| | | 440V | 0.25 | 0.25 | 0.25 |
| Maximum operating cycles per hour | | 1800 | 1800 | 1800 | 1800 |
| Conductor size (Solid, stranded) | AWG | 18-10 | 18-10 | 18-10 | 18-10 |
| | (The max. number of conducts : 2) mm ² | 1-2.5 | 1-2.5 | 1-2.5 | 1-2.5 |

Pneumatic timer



Air pressure timer

It is attached to the head-on of the magnetic contactor. It uses the principle of air pressure and it is delayed by the set time after the magnetic contactor is inserted and released and then the auxiliary contact of the Pneumatic timer is reversed

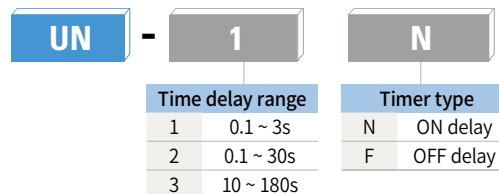

Note) Applicable MC: MC-6a ~ 100a, MC-9b ~ 22b, AC operation voltage



Combination with MC

| Type | MC-6a~100a / MC-9b~22b | | | | | |
|-----------------------------|-------------------------------------|---------------|---------|--------|---------|---------|
| | UN-1N | UN-2N | UN-3N | UN-1F | UN-2F | UN-3F |
| Standards | IEC60947-5-1, GB14048.5 | | | | | |
| Certification | CCC, CE | | | | | |
| Degree of protection | IP20 | | | | | |
| Temperature range | Storage | -25°C ~ +60°C | | | | |
| | Operation | -5°C ~ +40°C | | | | |
| Altitude | 2,000m less | | | | | |
| Poles | 1NO + 1NC | | | | | |
| Rated operating voltage | 690V | | | | | |
| Rated insulation voltage | 690V | | | | | |
| Frequency | 50/60Hz | | | | | |
| Rated operation current(Ie) | A600(AC-15), Q600(DC-13) | | | | | |
| Ith(Thermal current) | 10A | | | | | |
| Minimum switching current | 10mA | | | | | |
| Irms rated making capacity | 10 x Ie AC-15 acc. to IEC 60947-5-1 | | | | | |
| Non overlap time | 1.5ms | | | | | |
| Setting time | 0.1~3s | 0.1~30s | 10~180s | 0.1~3s | 0.1~30s | 10~180s |
| Operating time tolerance | ±50% less | | | | | |
| Mechanical durability | 2.5 mil. operations | | | | | |

On Delay timer block(UN-N)

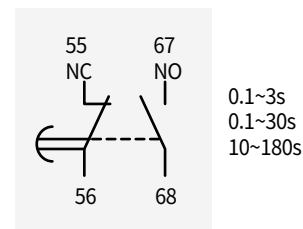

Off Delay timer block(UN-F)

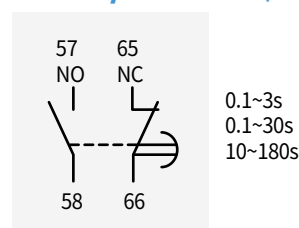

Mechanical latch unit ML, AL



Rating

| Applying contactors | Type | Coil voltage of latch unit | | | | | | | | | | | | | |
|---|----------------------------------|---|-----------------------------------|-------------------|----------------|----------------------------------|----------------|----------------------------------|-----------------|-----------------------------------|-----------------|-----------------------------------|---------|----------------------|--|
| MC-6a/L MC-9a/L MC-12a/L MC-18a/L MC-9b/L MC-12b/L MC-18b/L MC-22b/L MC-32a/L MC-40a/L MC-50a/L MC-65a/L | ML-65 | <table border="1"> <thead> <tr> <th>Ordering voltage</th> <th>Operation voltage</th> </tr> </thead> <tbody> <tr> <td>AC 24V/ DC 24V</td> <td>AC 24V 50/60Hz, DC 24V</td> </tr> <tr> <td>AC 48V/ DC 48V</td> <td>AC 48V 50/60Hz, DC 48V</td> </tr> <tr> <td>AC 100V/DC 100V</td> <td>AC 100~127V 50/60Hz, DC 100V~125V</td> </tr> <tr> <td>AC 200V/DC 200V</td> <td>AC 200~240V 50/60Hz, DC 200V~220V</td> </tr> <tr> <td>AC 400V</td> <td>AC 380V~440V 50/60Hz</td> </tr> </tbody> </table> | Ordering voltage | Operation voltage | AC 24V/ DC 24V | AC 24V 50/60Hz, DC 24V | AC 48V/ DC 48V | AC 48V 50/60Hz, DC 48V | AC 100V/DC 100V | AC 100~127V 50/60Hz, DC 100V~125V | AC 200V/DC 200V | AC 200~240V 50/60Hz, DC 200V~220V | AC 400V | AC 380V~440V 50/60Hz | |
| | | Ordering voltage | Operation voltage | | | | | | | | | | | | |
| | | AC 24V/ DC 24V | AC 24V 50/60Hz, DC 24V | | | | | | | | | | | | |
| | | AC 48V/ DC 48V | AC 48V 50/60Hz, DC 48V | | | | | | | | | | | | |
| | | AC 100V/DC 100V | AC 100~127V 50/60Hz, DC 100V~125V | | | | | | | | | | | | |
| | | AC 200V/DC 200V | AC 200~240V 50/60Hz, DC 200V~220V | | | | | | | | | | | | |
| AC 400V | AC 380V~440V 50/60Hz | | | | | | | | | | | | | | |
| MC-75a/L MC-85a/L MC-100a/L MC-130a/L MC-150a/L | ML-150 | * Coils for 24, 48, 100, 200V are AC / DC common. | | | | | | | | | | | | | |
| | | <table border="1"> <thead> <tr> <th>Ordering voltage</th> <th>Operation voltage</th> </tr> </thead> <tbody> <tr> <td>AC 100V</td> <td>AC 100~127V 50/60Hz, DC 100~110V</td> </tr> <tr> <td>AC 200V</td> <td>AC 200~240V 50/60Hz, DC 200~220V</td> </tr> </tbody> </table> | Ordering voltage | Operation voltage | AC 100V | AC 100~127V 50/60Hz, DC 100~110V | AC 200V | AC 200~240V 50/60Hz, DC 200~220V | | | | | | | |
| | | Ordering voltage | Operation voltage | | | | | | | | | | | | |
| AC 100V | AC 100~127V 50/60Hz, DC 100~110V | | | | | | | | | | | | | | |
| AC 200V | AC 200~240V 50/60Hz, DC 200~220V | | | | | | | | | | | | | | |
| * For using safely the product providing DC control power, Please consider that the maximum switching frequency should be less than 150 times/hour. | | | | | | | | | | | | | | | |
| MC-185a/L, 225a/L | AL-225 | <table border="1"> <thead> <tr> <th>Ordering voltage</th> <th>Operation voltage</th> </tr> </thead> <tbody> <tr> <td>AC 100V</td> <td>AC 100~127V 50/60Hz, DC 100~110V</td> </tr> <tr> <td>AC 200V</td> <td>AC 200~240V 50/60Hz, DC 200~220V</td> </tr> </tbody> </table> | Ordering voltage | Operation voltage | AC 100V | AC 100~127V 50/60Hz, DC 100~110V | AC 200V | AC 200~240V 50/60Hz, DC 200~220V | | | | | | | |
| Ordering voltage | Operation voltage | | | | | | | | | | | | | | |
| AC 100V | AC 100~127V 50/60Hz, DC 100~110V | | | | | | | | | | | | | | |
| AC 200V | AC 200~240V 50/60Hz, DC 200~220V | | | | | | | | | | | | | | |
| MC-265a/L, 330a/L, 400a/L | AL-400 | * For using safely the product providing DC control power, Please consider that the maximum switching frequency should be less than 150 times/hour. | | | | | | | | | | | | | |

Note) Latch units for upto MC-150 are supplied separately.
 From MC-185 the units are assembled at factory.
 ML-65 can also be attached to MR

To install

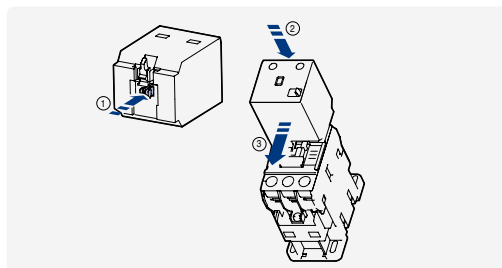

1. Push the black bar
2. Position the Latch on the top of the contactor
3. Pull in the direction of the arrow until snapping

To separate



1. Pull the black lever in the direction of the arrow.
2. Pull up the yellow lever.
3. Push the latch in the direction of the arrow.

Delayed opening devices, AD

Delayed opening device prevents the inadvertent opening of a contactor in the event of a wide voltage drop or brief supply voltage interruptions of control power for 1 to 7 seconds.



| Applying contactors | Type | Rated voltage | MC Rated voltage | Durability | | Performance |
|---------------------|--------|---------------|------------------|------------------|--------------------|--|
| | | | | Mechanical | Electrical | |
| MC-6a~18a | AD-9 | AC 110V | DC 110V | 5 mil operations | 1 mil operations | <ul style="list-style-type: none"> Making/Breaking capacity at AC3 <ul style="list-style-type: none"> - Making current : min. 10xIn - Breaking current : min. 8xIn Max. operating rate : 600 operations/hour Delaying time : 1-7sec. Capacitor durability <ul style="list-style-type: none"> 1) Operation :> 0.1 mil. operations 2) Cumulative charge life at AC 200/220V <ul style="list-style-type: none"> - 45°C or less: 80,000 hours - 50°C or less: 60,000 hours |
| MC-9b~22b | | AC 220V | DC 220V | | | |
| MC-32a~40a | AD-32 | AC 110V | DC 110V | | | |
| | | AC 220V | DC 220V | | | |
| MC-50a~100a | AD-50 | AC 110V | DC 110V | | | |
| | | AC 220V | DC 220V | | | |
| MC-130a~225a | AD-100 | AC 100~240V | AC/DC 100~240V | | 0.5 mil operations | |
| MC-265a~400a | AD-300 | AC 100~240V | AC/DC 100~240V | | | |
| MC-500a~800a | AD-600 | AC 100~127V | AC/DC 100~127V | | | |
| | | AC 200~240V | AC/DC 200~240V | | | |

*AD shall be used for DC type contactor

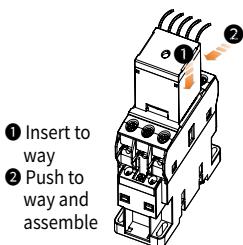

Electronic timer unit, UT

| Applying contactors | Type | Rated voltage | Performance |
|-----------------------------------|-----------|---------------|---|
| MC-6a~150a MC-9b~22b MR-4~8 | On delay | UT-1N | AC/DC 24~48V |
| | | UT-2N | AC 110~220V |
| | Off delay | UT-1F | AC/DC 24~48V |
| | | UT-2F | AC 110~220V |
| | | | <ul style="list-style-type: none"> Mounting: Head on Contact: 1c Time delay: 1 Sec~30 Sec On delay, Off delay Frequency: AC 50/60Hz Operation: Min. voltage 85%, Max. voltage 110% Accuracy of setting time: ±20% |

Terminal cover units for contactors, AP

| Applying contactors | Type | | Remarks |
|---------------------------|----------|-------------|------------------------------|
| | Standard | Transparent | |
| MC-6a,9a,12a,18a (18AF) | AP-18 | AP/T-6 | 2 pcs required per contactor |
| MC-9b,12b,18b,22b (22AF) | AP-22 | AP/T-9 | |
| MC-32a,40a (40AF) | AP-40 | AP/T-32 | |
| MC-50,65a (65AF) | AP-65 | AP/T-50 | |
| MC-75a,85a,100a (100AF) | AP-100 | AP/T-75 | |
| MC-130a,150a (150AF) | AP-150 | AP/T-130 | |
| MC-185a,225a (225AF) | AP-220 | AP/T-185 | |
| MC-265a,330a,400a (400AF) | AP-400 | AP/T-265 | |
| MC-500a,630a,800 (800AF) | AP-800 | AP/T-500 | |

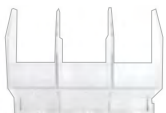

Insulation barrier units, AI

| Applying contactors | Type | Remarks |
|--------------------------------|---------|------------------------------|
| MC-130a, 150a | AI-180 | 4 pcs required per contactor |
| MC-185a, 225a | | |
| MC-265a, 330a, 400a | | |
| MC-500a, 630a, 800a, 1260a | AI-800 | |
| MC-1400a, 1700a, 2100a | AI-2100 | |
| MC-2650a, MCI-1700, 2100, 2650 | AI-2650 | |
| MCI-900, 1050, 1260 | AI-1260 | |

* The insulation barrier for MC-150a is available on the screw type only.

Interlocks

Component parts for assembling by customer

Interlock unit, UR-02 and AR-9 & Wire kit UW

UR-02 is a mechanical interlock unit and provides 2NC contacts for use in electrical interlocking

UW is used for making reversing circuit between two contactors.

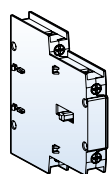

Interlock unit

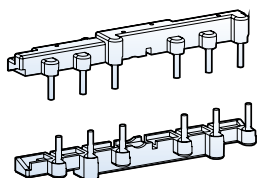

Wire kit

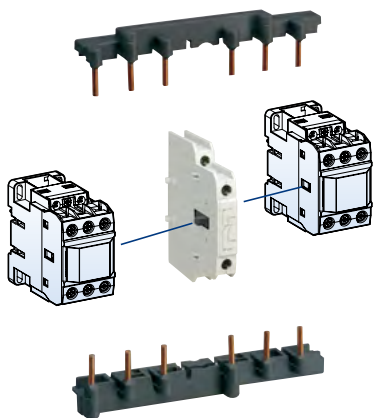

| Contactor | Pole | Wire kit | | Interlock unit | | Aux Contact | |
|--------------|------|----------|--------|----------------|--------|-------------|---|
| | | Type | Weight | Type | Weight | | |
| MC-6a~18a | 3P | UW-18 | 0.05kg | UR-02 | 0.06kg | 2NC | |
| | 4P | - | - | | | | |
| MC-9b~22b | 3P | UW-22 | 0.04kg | | | - | - |
| MC-32a~40a | | UW-32 | 0.05kg | | | | |
| MC-50a, 65a | | UW-63 | 0.12kg | | | | |
| MC-75a~100a | | UW-95 | 0.33kg | | | | |
| MC-130a~150a | | UW-150 | 0.6kg | | | | |
| MC-22a~85a | 4P | - | - | AR-9 | 0.05kg | - | |

Rating of the contacts in the interlocks

| | | | | |
|--------------------------|------------------|------------------|------|-------|
| Rated operation voltage | | 600V | | |
| Rated insulation voltage | | 1000V | | |
| Rated frequency | | 50/60Hz | | |
| Rated thermal current | | 16A | | |
| Rated operation current | AC15 duty (A600) | 120V | 6A | |
| | | 240V | 3A | |
| | | 380V | 1.9A | |
| | | 480V | 1.5A | |
| | | 500V | 1.4A | |
| | | 600V | 1.2A | |
| | | DC13 duty (Q300) | 125V | 0.55A |
| | | | 250V | 0.27A |

MC-6aR ~ MC-150aR typical circuit diagram for reversing contactor

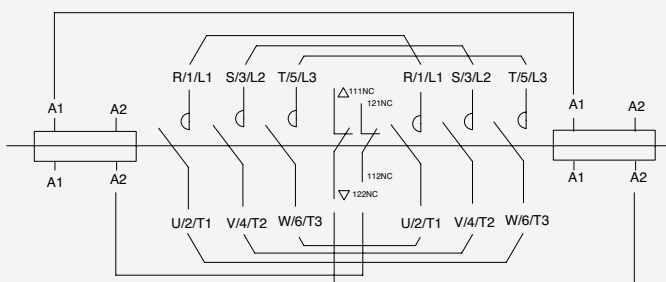

Interlock unit, AR-180 and AR-600

AR-180 and AR-600 are mechanical interlock units in which electrical contacts for use in electrical interlocking are not included. Please use the auxiliary contacts on the sides of the contactors for that purpose.

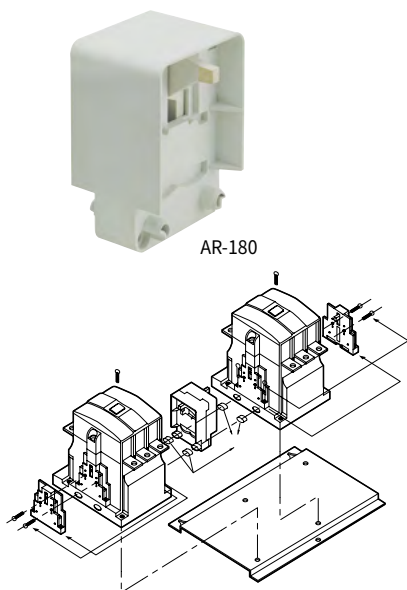

AR-180

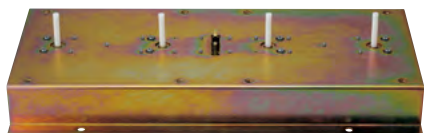

AR-600 & AR-600/V

| Contactor | Pole | Interlock unit | |
|-----------|------|--------------------|--------|
| | | Type | Weight |
| MC-100a | 4P | AR-180 | 0.09kg |
| MC-130a | | | |
| MC-150a | | | |
| MC-185a | | | |
| MC-225a | | | |
| MC-265a | 3,4P | AR-600 AR-600/V | 15.2kg |
| MC-330a | | | |
| MC-400a | | | |
| MC-500a | | | |
| MC-630a | 3,4P | AR-600 AR-600/V | 15.2kg |
| MC-800a | | | |

* AR-600 3pole product is different fro, AR-600 4pole product in size.

* The AR-600 / V is a vertical interlock unit.

MC-180aR ~ MC-800aR typical circuit diagram for reversing contactor

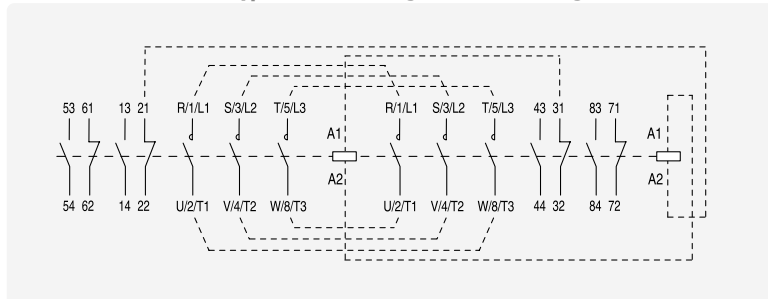

Installation of interlock and wire kits

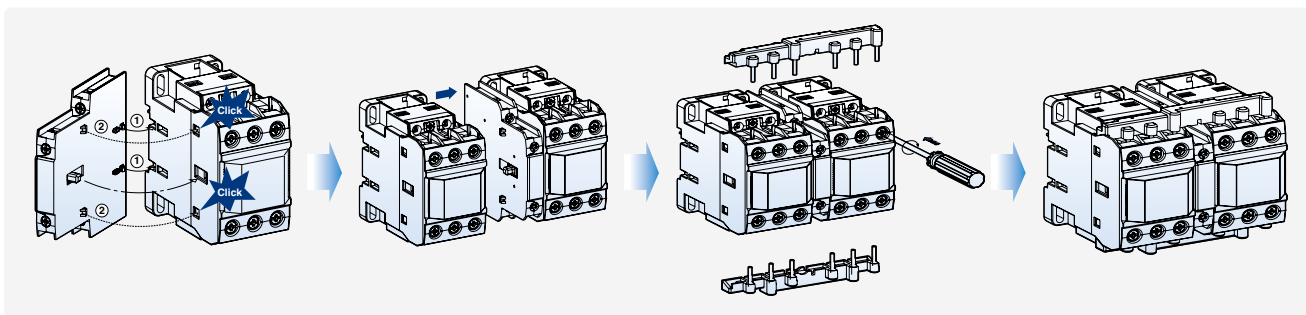

Install the interlock unit on the side of a contactor first. fit each part as indicated in the fig.

And then install the other contactor on the other side of the interlock unit as shown.

After installing interlock unit wiring kit can be assembled. Wiring kit contains two molded wires - one for line side and the other for load side.

- In case of assembling Reversing contactor, please check the R, S, T/U, V, W mark on the contactor and Wire kit.

Surge unit

- It absorbs the surge arisen out of the coil of the contactor.
- It can be installed simply to the contactor.
 - Rated operation voltage (Ue): AC 24 ~ 440V / DC 24 ~ 125V
 - Rated insulation voltage (Ui): 1000V
 - Rated impulse withstand voltage (Uimp): 8kV
 - Degree of protection: IP20
 - Combination with 3Pole 6a/3~150a/3, 4Pole 32a/4~85a/4

US Type

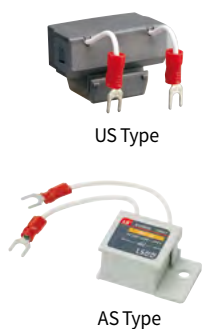

| Surge unit | | Rated voltage | | Internal elements spec. | | | Contactor |
|------------|-------------|-----------------|----------|-------------------------|------|--------|---|
| Type | Composition | | | V | R | C | |
| US-1 | Varistor+RC | AC | 24~48V | 120V | 100Ω | 0.1μF | 3Pole MC 6a~150a 9b~22b 4Pole MC 6a/4~18a/4 |
| US-2 | Varistor+RC | | 100~125V | 270V | 100Ω | 0.1μF | |
| US-3 | Varistor+RC | | 200~240V | 470V | 100Ω | 0.1μF | |
| US-4 | Varistor+RC | DC | 24~48V | 120V | 100Ω | 0.47μF | |
| US-5 | Varistor+RC | | 100~125V | 270V | 100Ω | 0.47μF | |
| US-6 | Varistor+RC | | 200~220V | 470V | 100Ω | 0.47μF | |
| US-11 | Varistor | AC/DC Common | 24~48V | 120V | - | - | |
| US-12 | Varistor | | 100~125V | 270V | - | - | |
| US-13 | Varistor | | 200~240V | 470V | - | - | |
| US-14 | Varistor | | 380~440V | 1000V | - | - | |
| US-22 | RC | AC | 100~125V | - | 56Ω | 1μF | |

Installation (US Type)

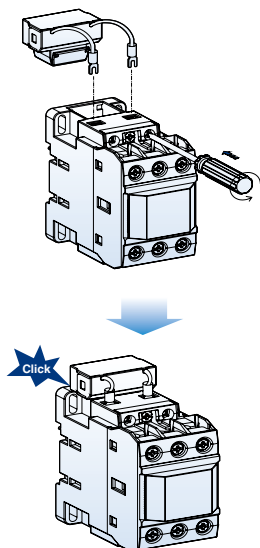



Connect the lead wires to the coil terminals of the contactor first. And then insert the body into the space of the contactor as shown above.

AS Type

| Surge unit | | Rated voltage | | Internal elements spec. | | | Contactor |
|------------|-------------|-----------------|----------|-------------------------|-------|--------|---|
| Type | Composition | | | V | R | C | |
| AS-1 | Varistor+RC | AC | 24~48V | 120V | 100Ω | 0.1μF | 3Pole MC 185a~800a 4Pole MC 22a/4~800a/4 |
| AS-2 | Varistor+RC | | 100~125V | 270V | 100Ω | 0.1μF | |
| AS-3 | Varistor+RC | | 200~240V | 470V | 100Ω | 0.1μF | |
| AS-4 | Varistor+RC | DC | 24~48V | 120V | 100Ω | 0.47μF | |
| AS-5 | Varistor+RC | | 100~125V | 270V | 100Ω | 0.47μF | |
| AS-6 | Varistor+RC | | 200~220V | 470V | 100Ω | 0.47μF | |
| AS-11 | Varistor | AC/DC Common | 24~48V | 120V | - | - | |
| AS-12 | Varistor | | 100~125V | 270V | - | - | |
| AS-13 | Varistor | | 200~240V | 470V | - | - | |
| AS-14 | Varistor | | AC | 380~440V | 1000V | - | - |

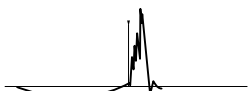
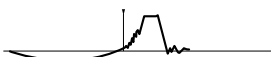
Specification of surge unit

| Without surge unit | ① With varistor unit | ② With CR+Varistor unit |
|---|--|---|
| Surge voltage, arise when the coil is off, may provoke mis-operation and damage in the circuit. | Varistor has an effect to cut down the peak voltage | Varistor has an effect to cut down the peak voltage and high frequency wave |
|  |  |  |

Capacitor unit

Capacitor unit is connected to the terminals of the contactor to reduce the high inrush current.
IEC 60947-5-1



| Type (AUX Contact 1b) | | AC-9 (1b) | AC-50 (1b) | AC-75 (1b) | |
|------------------------------|-------|-------------------------------|------------|------------|------|
| Rating thermal current (Ith) | | 16A | 16A | 16A | |
| Current | AC-15 | Rated Operational Current (A) | 120V | 6 | 6 |
| | | | 240V | 3 | 3 |
| | | | 380V | 1.9 | 1.9 |
| | | | 480V | 1.5 | 1.5 |
| | | | 500V | 1.4 | 1.4 |
| | DC-13 | Rated Operational Current (A) | 600V | 1.2 | 1.2 |
| | | | 125V | 0.55 | 0.55 |
| | | | 250V | 0.27 | 0.27 |
| | | | 400V | 0.15 | 0.15 |
| | | | 500V | 0.13 | 0.13 |
| | | 600V | 0.1 | 0.1 | |

Features of capacitor unit (Pre-loading resistor)

- Damping resistor that can limit the inrush current upto $60 \times I_n$ is connected to the mechanism that closed earlier than the main contact of the contactor
- No heat loss by the serial resistor
- Eliminate the switching surge
- Improving the performance of the capacitor system

Operation sequence

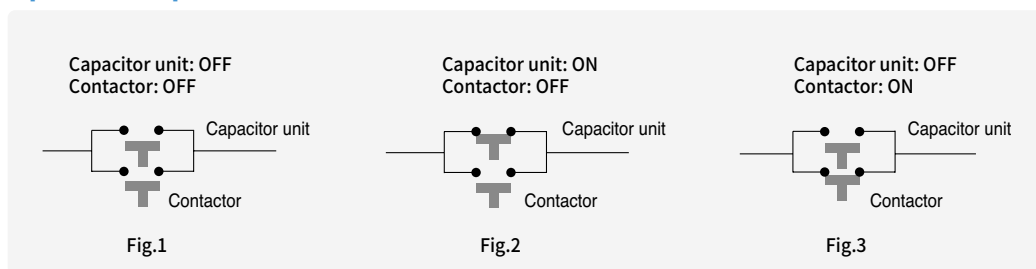

Note) Closing sequence: Fig.1 => Fig.2 => Fig.3
Opening sequence: Fig.3 => Fig.1

Replacement coils

To replace the existing coil to change voltage or repair.



| Contactor | Coil voltage | | | | | | | |
|--|--------------|-----|-------------|-----|----------------|---------|---------|-----|
| | AC coil | | | | | | DC coil | |
| | AC 60Hz (V) | | AC 50Hz (V) | | AC 50/60Hz (V) | | DC (V) | |
| MC-6a MC-9a MC-12a MC-18a MR-4, 6, 8 | 24 | 230 | 24 | 230 | 24 | 240 | | |
| | 48 | 240 | 36 | 240 | 48 | 380 | | |
| | 100 | 277 | 42 | 380 | 100 | 415 | | |
| | 110 | 380 | 48 | 400 | 110 | 440 | | |
| | 120 | 440 | 80 | 415 | 120 | 500 | | |
| | 200 | 480 | 100 | 440 | 200 | 550 | | |
| | 208 | 600 | 110 | 500 | 220 | | | |
| | | 220 | 550 | 230 | | | | |
| MC-9b MC-12b MC-18b MC-22b | 24 | 230 | 24 | 230 | 24 | 240 | | |
| | 48 | 240 | 36 | 240 | 48 | 380 | | |
| | 100 | 277 | 42 | 380 | 100 | 415 | | |
| | 110 | 380 | 48 | 400 | 110 | 440 | | |
| | 120 | 440 | 80 | 415 | 120 | 500 | | |
| | 200 | 480 | 100 | 440 | 200 | 550 | | |
| | 208 | 600 | 110 | 500 | 220 | | | |
| | | 220 | 550 | 230 | | | | |
| MC-32a MC-40a | 24 | 230 | 24 | 230 | 24 | 240 | 12 | 110 |
| | 48 | 240 | 36 | 240 | 48 | 380 | 20 | 125 |
| | 100 | 277 | 42 | 380 | 100 | 415 | 24 | 200 |
| | 110 | 380 | 48 | 400 | 110 | 440 | 48 | 220 |
| | 120 | 440 | 80 | 415 | 120 | 500 | 60 | 250 |
| | 200 | 480 | 100 | 440 | 200 | 550 | 80 | |
| | 208 | 600 | 110 | 500 | 220 | | 100 | |
| | | 220 | 550 | 230 | | | | |
| MC-50a MC-65a | 24 | 230 | 24 | 230 | 24 | 240 | 12 | 110 |
| | 48 | 240 | 36 | 240 | 48 | 380 | 20 | 125 |
| | 100 | 277 | 42 | 380 | 100 | 415 | 24 | 200 |
| | 110 | 380 | 48 | 400 | 110 | 440 | 48 | 220 |
| | 120 | 440 | 80 | 415 | 120 | 500 | 60 | 250 |
| | 200 | 480 | 100 | 440 | 200 | 550 | 80 | |
| | 208 | 600 | 110 | 500 | 220 | | 100 | |
| | | 220 | 550 | 230 | | | | |
| MC-75a MC-85a MC-100a | 24 | 230 | 24 | 230 | 24 | 240 | 12 | 110 |
| | 48 | 240 | 36 | 240 | 48 | 380 | 20 | 125 |
| | 100 | 277 | 42 | 380 | 100 | 415 | 24 | 200 |
| | 110 | 380 | 48 | 400 | 110 | 440 | 48 | 220 |
| | 120 | 440 | 80 | 415 | 120 | 500 | 60 | 250 |
| | 200 | 480 | 100 | 440 | 200 | 550 | 80 | |
| | 208 | 600 | 110 | 500 | 220 | | 100 | |
| | | 220 | 550 | 230 | | | | |
| MC-130a MC-150a | | | | | 24 | 220~240 | 24 | 110 |
| | | | | | 48 | 300 | 48 | 220 |
| | | | | | 24~48 | 380~440 | 24~48 | |
| | | | | | 100~240 | 500 | 70~110 | |
| | | | | | 110~120 | | 100~220 | |

Replacement process

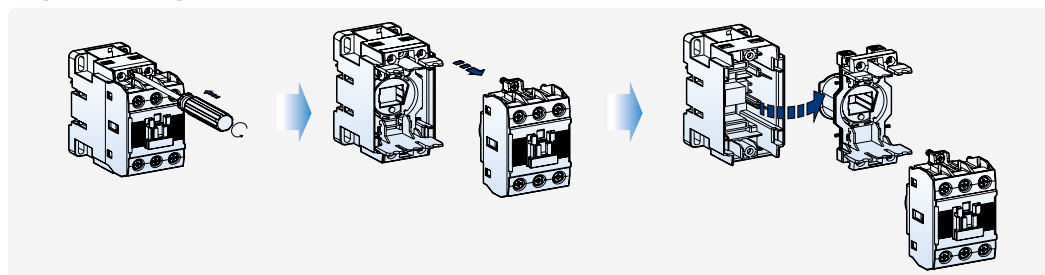

To replace the existing coil to change voltage or repair.



| Contactor | Coil voltage | |
|--|-----------------------------|-------------------|
| | AC/DC common coil (V) | AC coil (V) |
| MC-185a MC-225a | 24 48 100~240/100~220 | 300 400 500 |
| MC-265a MC-300a MC-400a | DC 24 100~240/100~220 | 300 400 500 |
| MC-500a MC-630a MC-800a MCI-900 MCI-1050 | 100/100 200/200 | 300 400 500 |
| MC-1260 MCI-1260 | 100~240/100~220 | - |
| MC-1400a MC-1700a MC-2100a MC-2650a MCI-1700 MCI-2100 MCI-2650 | 100~240/100~220 | - |

Safety cover (Option)

To prevent arc from coming out from the contactor To protect from unintended manual operation To prevent dust from entering into the inside of the contactor

| Type | Contactor |
|--------|--------------|
| AP-9 | MC-6a~150a |
| AP-185 | MC-185a~800a |

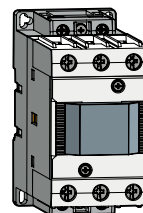

Overload relays

General descriptions

Type MT, bimetal-style, overload relays are designed to protect AC circuits and motors against overloads, phase failure, long starting times and prolonged stalling of the motor.

Four versions are available according to the protection function and trip class as below.

1. Non-differential: 3pole-2bimetal(Heater) and trip class 10A
2. Non-differential: 3pole-3bimetal(Heater) and trip class 10A
3. Differential: 3pole-3bimetal(Heater) and trip class 10A
4. Differential: 3pole-3bimetal(Heater) and trip class 20

Configuration of the front

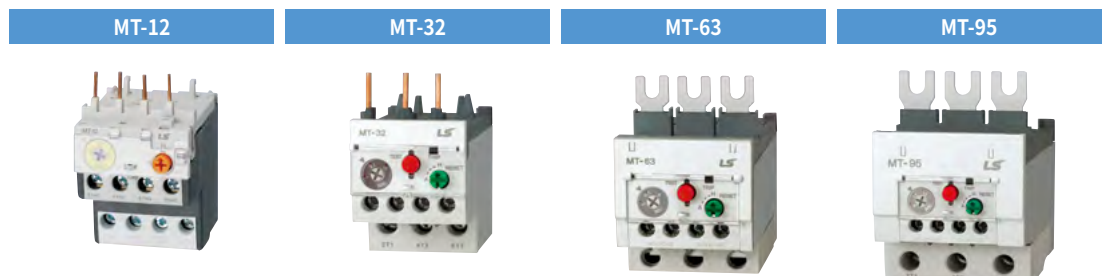
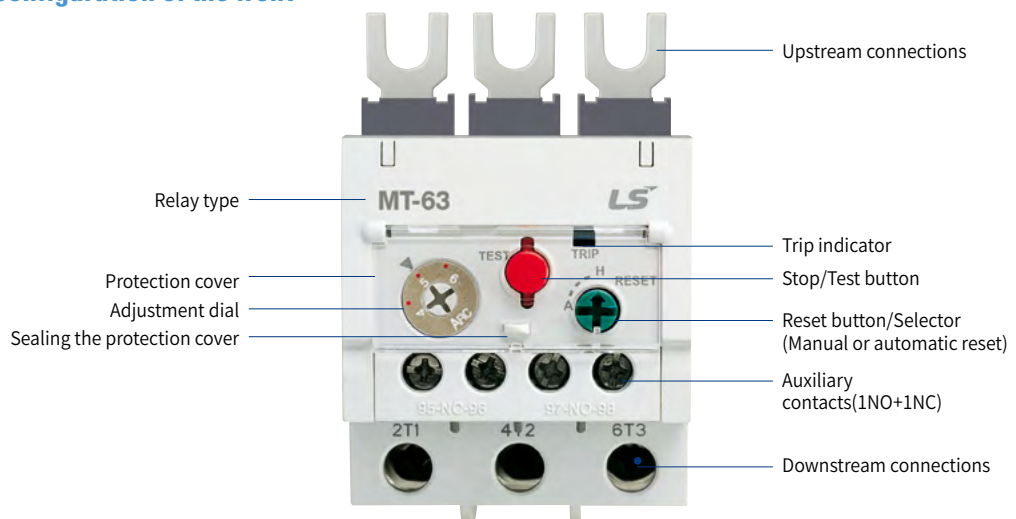

Environment and auxiliary circuit

| Environment | | MT-12~800 | |
|---|----------------------|-------------------------------------|-------------------------|
| Standards | | IEC/EN 60947-1, IEC/EN 60947-4-1 | |
| Certifications | | CE, CSA, UL, CCC | |
| Rated operation voltage | | Max. 690V | |
| Rated insulation voltage | | 690V | |
| Rated frequency | | 50/60Hz | |
| Degree of protection (Conforming to IEC 60 529) | | IP 20 | |
| Ambient air temperature | Storage | -30 ~ +65°C | |
| | Operation | -25 ~ +60°C (MT refer to Graph) | |
| Mounting position | | Vertical plane | |
| Shock resistance (Conforming to IEC 68-2-7) | | 15gn - 11ms | |
| Vibration resistance (Conforming to IEC68-2-6) | | 6G | |
| Insulation strength (Conforming to IEC 255-5) | | 6kV | |
| Rated impulse withstand voltage (Conforming to IEC 801-5) | | 6kV | |
| Auxiliary contacts characteristics | | | |
| Composition | | 1NO +1NC | |
| Rated thermal current | | 5A | |
| Rated operation current | | C600, R300 | |
| AC15 duty (C600) | 120V | 1.5A | |
| | 240V | 0.75A | |
| | 380V | 0.47A | |
| | 480V | 0.375A | |
| | 500V | 0.35A | |
| | 600V | 0.3A | |
| | DC13 duty (R300) | 120V | 0.22A |
| | | 240V | 0.1A |
| | Connecting conductor | Size | 18AWG /1mm ² |
| | | Connection to screw clamp terminals | Type |

MT-150



MT-225



MT-400

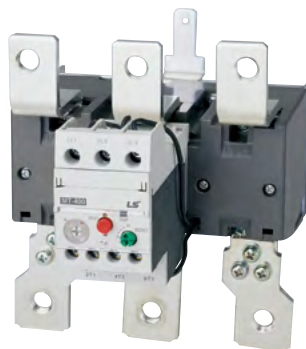

MT-800



Overload relay specifications



MT type Thermal overload relays

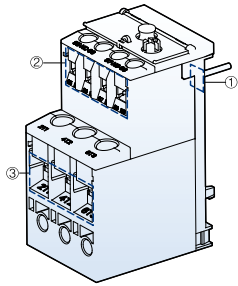

- ① Main terminals/upstream
- ② Auxiliary terminals
- ③ Main terminals/downstream

| Frame size | | 18AF | | |
|-----------------------------------|--------------------------------|---------------------|------------|---------|
| Trip class | | 10A | 20 | |
| Type | Non-differential (3P-2 heater) | MT-12/2H□S | - | |
| | Non-differential (3P-3 heater) | MT-12/3H□S | - | |
| | Differential type | MT-12/3K□S | MT-12/3D□S | |
| Terminals | Main-upstream | Screw clamp | | |
| | Main-downstream | Screw clamp | | |
| | Auxiliary | Screw clamp | | |
| Number of poles | | 3 | | |
| Rated operational voltage (Ue) | | 690V | | |
| Rated insulation voltage (Ui) | | Up to 690V | | |
| Rated impulse voltage (Uimp) | | 6kV | | |
| Degree of protection (IEC 60 529) | | IP 20 | | |
| Temperature compensation (°C) | | -5~+40°C | | |
| Functions | Trip indicating | ■ | | |
| | Stop | - | | |
| | Test | ■ | | |
| | Manual/Automatic reset | ■ | | |
| Setting range(A) | | 0.1~18A | 1~18A | |
| Nominal current rating | Wire size | | | |
| | mm ² | AWG | | |
| 0.14 | 1 | 18 | 0.1~0.16 | |
| 0.21 | | | 0.16~0.25 | |
| 0.33 | | | 0.25~0.4 | |
| 0.52 | | | 0.4~0.63 | |
| 0.82 | | | 0.63~1 | |
| 1.3 | | | 1~1.6 | 1~1.6 |
| 2.1 | | | 1.6~2.5 | 1.6~2.5 |
| 3.3 | | | 2.5~4 | 2.5~4 |
| 5 | | | 4~6 | 4~6 |
| 6.5 | | | 5~8 | 5~8 |
| 7.5 | 1~1.5 | 18~16 | 6~9 | |
| 8.5 | | | 7~10 | 7~10 |
| 11 | 1.5~2.5 | 16~14 | 9~13 | |
| 15 | 2.5 | 14~12 | 12~18 | |
| 19 | 2.5~4 | 12~10 | | |
| 21.5 | | | | |
| 27 | 4~6 | 10 | | |
| 30 | 4~10 | 10~8 | | |
| 34 | 6~10 | 10~8 | | |
| 42 | 10 | 8 | | |
| 54 | | | | |
| 65 | | | | |
| 74 | 16~25 | 6~4 | | |
| 83 | 25~35 | 4~3 | | |
| 90 | | | | |
| Applied contactors | | MC-6a, 9a, 12a, 18a | | |
| Separate mounting unit | | UZ-12 | | |

Note: Screw clamp and Lug types are available for the main terminals of 65AF, 100AF and 150AF relays.
The other AF relays provide Screw clamp types only.



| 40AF | | 65AF | | 100AF | |
|---|------------|-------------------------|--------------|-------------------------------|--------------|
| 10A | 20 | 10A | 20 | 10A | 20 |
| MT-32/2H□S | - | MT-63/2H□S/L | - | MT-95/2H□S/L | - |
| MT-32/3H□S | - | MT-63/3H□S/L | - | MT-95/3H□S/L | - |
| MT-32/3K□S | MT-32/3D□S | MT-63/3K□S/L | MT-63/3D□S/L | MT-95/3K□S/L | MT-95/3D□S/L |
| Screw clamp | | Screw/Lug clamp | | Screw/Lug clamp | |
| Screw clamp | | Screw/Lug clamp | | Screw/Lug clamp | |
| Screw clamp | | Screw clamp | | Screw clamp | |
| 3 | | 3 | | 3 | |
| 690V | | 690V | | 690V | |
| Up to 690V | | Up to 690V | | Up to 690V | |
| 6kV | | 6kV | | 6kV | |
| IP 20 | | IP 20 | | IP 20 | |
| -5~+40°C | | -5~+40°C | | -5~+40°C | |
| ■ | | ■ | | ■ | |
| ■ | | ■ | | ■ | |
| ■ | | ■ | | ■ | |
| ■ | | ■ | | ■ | |
| 0.1~40A | 1~40A | 4~65A | | 7~100A | |
| 0.1~0.16 | | | | | |
| 0.16~0.25 | | | | | |
| 0.25~0.4 | | | | | |
| 0.4~0.63 | | | | | |
| 0.63~1 | | | | | |
| 1~1.6 | 1~1.6 | | | | |
| 1.6~2.5 | 1.6~2.5 | | | | |
| 2.5~4 | 2.5~4 | | | | |
| 4~6 | 4~6 | 4~6 | 4~6 | | |
| 5~8 | 5~8 | 5~8 | 5~8 | | |
| 6~9 | 6~9 | 6~9 | 6~9 | | |
| 7~10 | 7~10 | 7~10 | 7~10 | 7~10 | 7~10 |
| 9~13 | 9~13 | 9~13 | 9~13 | 9~13 | 9~13 |
| 12~18 | 12~18 | 12~18 | 12~18 | 12~18 | 12~18 |
| 16~22 | 16~22 | 16~22 | 16~22 | 16~22 | 16~22 |
| 18~25 | 18~25 | 18~25 | 18~25 | 18~25 | 18~25 |
| 22~32 | 22~32 | - | - | - | - |
| - | - | 24~36 | 24~36 | 24~36 | 24~36 |
| 28~40 | 28~40 | 28~40 | 28~40 | 28~40 | 28~40 |
| | | 34~50 | 34~50 | 34~50 | 34~50 |
| | | 45~65 | 45~65 | 45~65 | 45~65 |
| | | | | 54~75 | 54~75 |
| | | | | 63~85 | 63~85 |
| | | | | 70~95 | 70~95 |
| | | | | 80~100 | 80~100 |
| MC-9b, 12b, 18b, 22b, 32a, 40a UZ-32 | | MC-50a, 65a UZ-63S/L | | MC-75a, 85a, 100a UZ-95S/L | |

Overload relay specifications

MT type Thermal overload relays

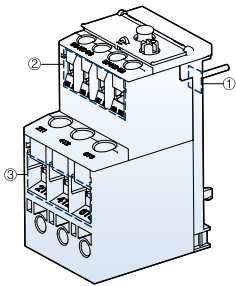

- ① Main terminals/upstream
- ② Auxiliary terminals
- ③ Main terminals/downstream

| Frame size | | | 150AF | |
|-----------------------------------|--------------------------------|--------|-----------------|----------------|
| Trip class | | | 10A | 20 |
| Type | Non-differential (3P-2 heater) | | MT-150/2HCIS/L | - |
| | Non-differential (3P-3 heater) | | MT-150/3HCIS/L | - |
| | Differential type | | MT-150/3KCIS/L | MT-150/3DCIS/L |
| Terminals | Main-upstream | | Screw/Lug clamp | |
| | Main-downstream | | Screw/Lug clamp | |
| | Auxiliary | | Screw clamp | |
| Number of poles | | | 3 | |
| Rated operational voltage (Ue) | | | 690V | |
| Rated insulation voltage (Ui) | | | 690V | |
| Rated impulse voltage (Uimp) | | | 6kV | |
| Degree of protection (IEC 60 529) | | | IP 20 | |
| Temperature compensation (°C) | | | -5~+40°C | |
| Functions | Trip indicating | | ■ | |
| | Stop | | ■ | |
| | Test | | ■ | |
| | Manual/Automatic reset | | ■ | |
| Setting range(A) | | | 34~150A | 34~150A |
| Nominal current rating | Wire size | | | |
| | mm ² | AWG | | |
| 42 | 10 | 8 | 34~50 | |
| 55 | 16 | 6 | 45~65 | |
| 65 | 25 | 4 | 54~75 | |
| 74 | 25 | 4 | 63~85 | |
| 80 | 35 | 3 | - | |
| 93 | 35 | 2 | 80~105 | |
| 107 | 50 | 1 | - | |
| 113 | 50 | 1 | 95~130 | |
| 130 | 50 | 0 | 110~150 | |
| 130 | 70 | 00 | | |
| 153 | 95 | 000 | | |
| 200 | 120 | 250 | | |
| 265 | 185 | 350 | | |
| 350 | 240 | 500 | | |
| 515 | 185×2n | 350×2n | | |
| 660 | 240×2n | 300×3n | | |
| Applied contactors | | | MC-130a, 150a | |
| Separate mounting unit | | | UZ-150S/L | |

Note: Screw clamp and Lug types are available for the main terminals of 65AF, 100AF and 150AF relays.
The other AF relays provide Screw clamp types only.



| 225AF | | 400AF | | 800AF | |
|---------------|-------------|---------------------|-------------|---------------------|---------------|
| 10A | 20 | 10A | 20 | 10A | 20 |
| MT-225/2H□S | - | MT-400/2H□S | - | MT-800/2H□S/L | - |
| MT-225/3H□S | - | MT-400/3H□S | - | MT-800/3H□S/L | - |
| MT-225/3K□S | MT-225/3D□S | MT-400/3K□S | MT-400/3D□S | MT-800/3K□S/L | MT-800/3D□S/L |
| Screw clamp | | Screw clamp | | Screw clamp | |
| Screw clamp | | Screw clamp | | Screw clamp | |
| Screw clamp | | Screw clamp | | Screw clamp | |
| 3 | | 3 | | 3 | |
| 690V | | 690V | | 690V | |
| 690V | | 690V | | 690V | |
| 6kV | | 6kV | | 6kV | |
| IP 20 | | IP 20 | | IP 20 | |
| -5~+40°C | | -5~+40°C | | -5~+40°C | |
| ■ | | ■ | | ■ | |
| ■ | | ■ | | ■ | |
| ■ | | ■ | | ■ | |
| ■ | | ■ | | ■ | |
| 65~240A | 65~240A | 85~400A | 85~400A | 200~800A | 200~800A |
| 65~100 | | | | | |
| - | | | | | |
| 85~125 | | 85~125 | | | |
| - | | - | | | |
| - | | - | | | |
| 100~160 | | 100~160 | | | |
| 120~185 | | 120~185 | | | |
| 160~240 | | 160~240 | | | |
| | | 200~330 | | 200~300 | |
| | | 260~400 | | 260~400 | |
| | | | | 400~600 | |
| | | | | 520~800 | |
| MC-185a, 225a | | MC-265a, 330a, 400a | | MC-500a, 630a, 800a | |
| - | | - | | - | |

Overload relay operation

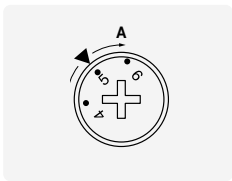
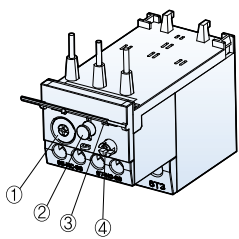
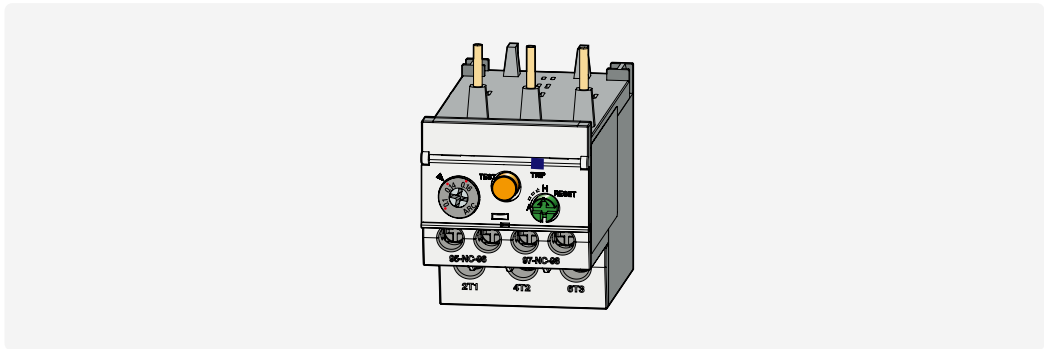

1. Adjustment dial

- Before adjusting the dial open the protection cover.
- Current setting can be done easily by using (+) or (-) driver and have to be set by dotting or graduations standard.
- Do not rotate the dial out of the setting range.

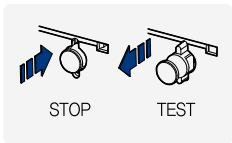

2. Stop/Test button

- STOP function is executed by pushing the button, which causes the next sequence.
- In case of operation test pull this button.

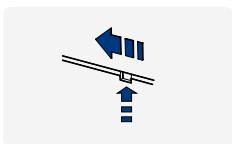

3. Trip indicator

- If relay is tripped it comes out.

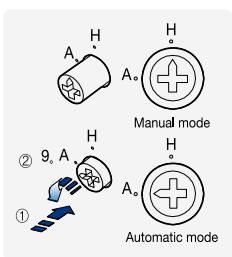

4. Reset button/Selector

- Using a driver the reset mode can be set.
- In case of Manual mode(H) push the button to reset the relay.
- To change to Automatic mode(A) from Manual mode push the button and rotate as shown in the fig.

5. Auxiliary contact operation

| Terminal no. | Normal | Stop | Test/Trip | Reset |
|--------------|--------|------|-----------|-------|
| NC 95-96 | | | | |
| NO 97-98 | | | | |

Separate mounting units

These accessories are used to mount the relays separately from contactors.
If a relay is combined with a unit, it can be mounted on DIN rail or panel by fixing screws.



| Relay | Unit | |
|--|-----------|--------|
| | Type | Weight |
| MT-12/2H□ MT-12/3H□ MT-12/3K□ MT-12/3D□ | UZ-12 | 35g |
| MT-32/2H□ MT-32/3H□ MT-32/3K□ MT-32/3D□ | UZ-32 | 68g |
| MT-63/2H□ MT-63/3H□ MT-63/3K□ MT-63/3D□ | UZ-63S/L | 134g |
| MT-95/2H□ MT-95/3H□ MT-95/3K□ MT-95/3D□ | UZ-95S/L | 230g |
| MT-150/2H□ MT-150/3H□ MT-150/3K□ MT-150/3D□ | UZ-150S/L | 284g |

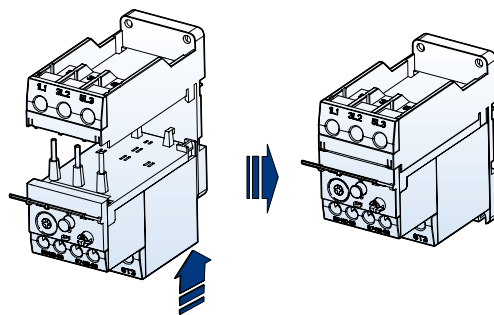

Terminal cover units for overload relays



| Relay | Remarks |
|--------|---------|
| MT-225 | 2 pcs |
| MT-400 | |

Accessories for overload relay

Remote reset units



These accessories are used to reset the relays on the panel door.

| Type | Cable length (L) |
|-------|------------------|
| UM-4R | 400 mm |
| UM-5R | 500 mm |
| UM-6R | 600 mm |
| UM-7R | 700 mm |
| UM-9R | 900 mm |

1. Make the reset bar straight at least 55mm from the panel door and 35mm from the bracket.
2. The bending radius of the flexible reset bar should not be less than 15mm.

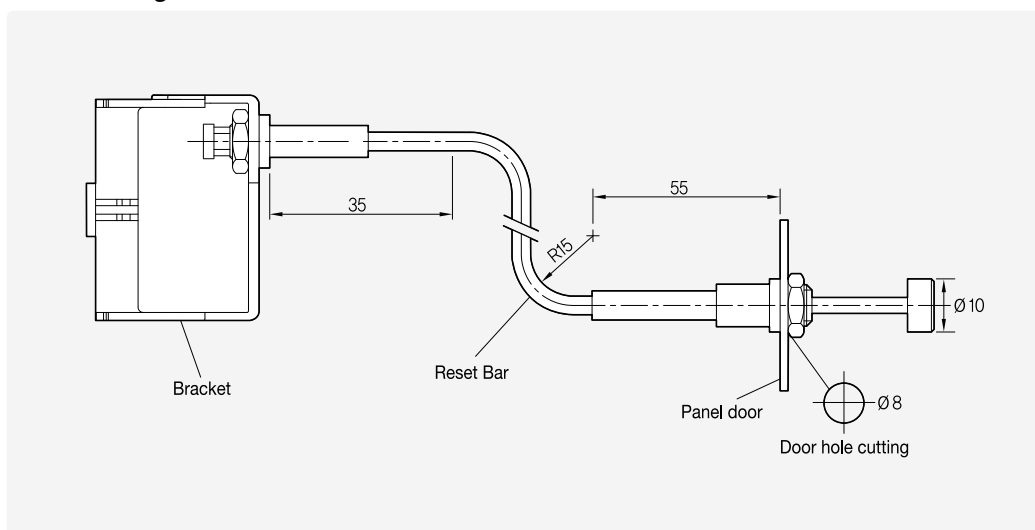

Installation

1. Fit the bracket with the relay as indicated(*1) below.
2. Separate Nut(*3) and Head cap(*4) from the reset bar first.
Insert the reset bar into the panel hole and then fix it with the Nut and Head.
3. To separate the bracket from the relay lift the *2 part as shown in the fig.

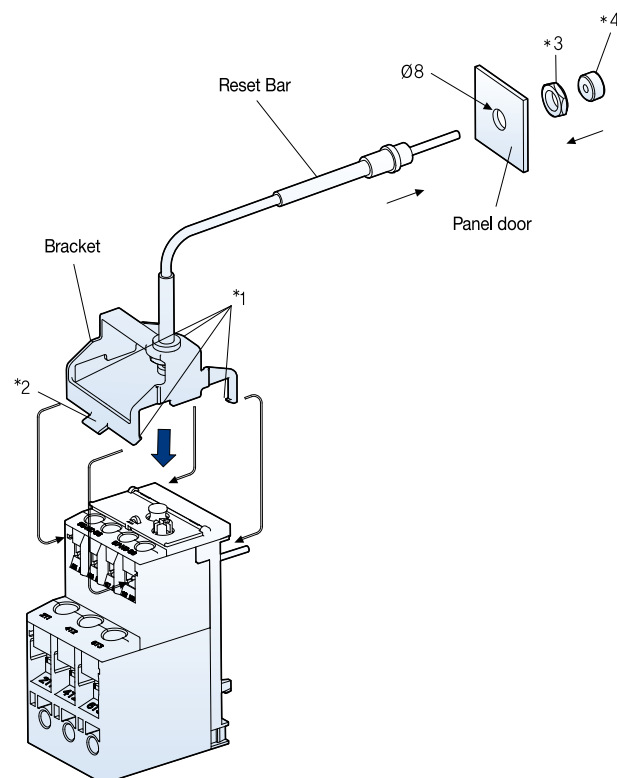
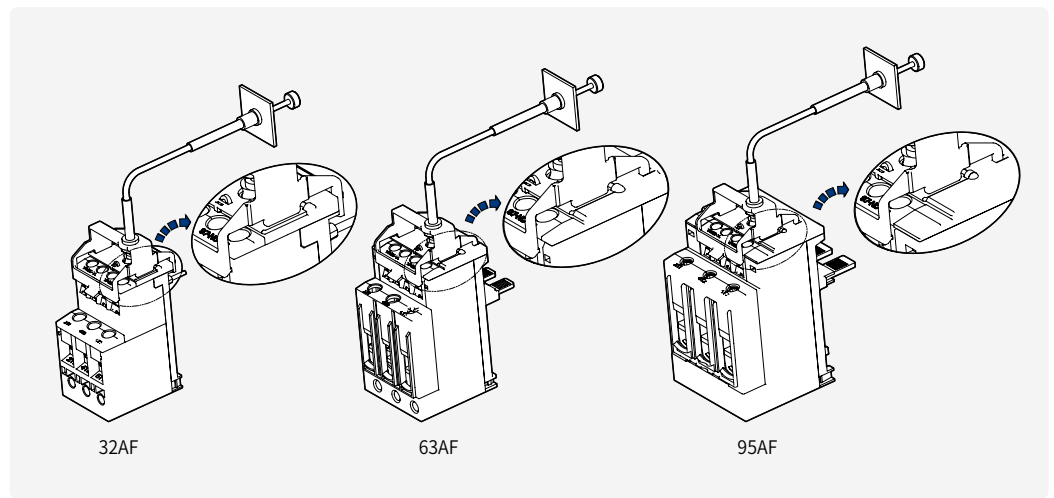

Accessories for overload relay

Remote reset units

MT-32

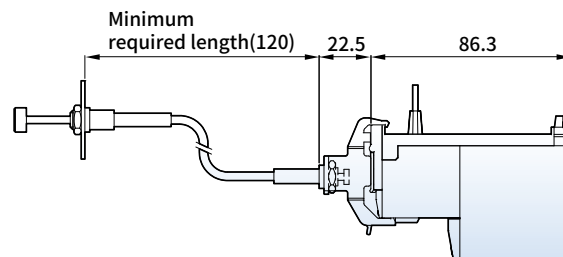

MT-63

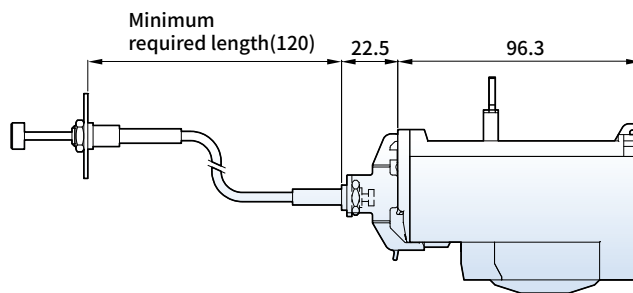

MT-95

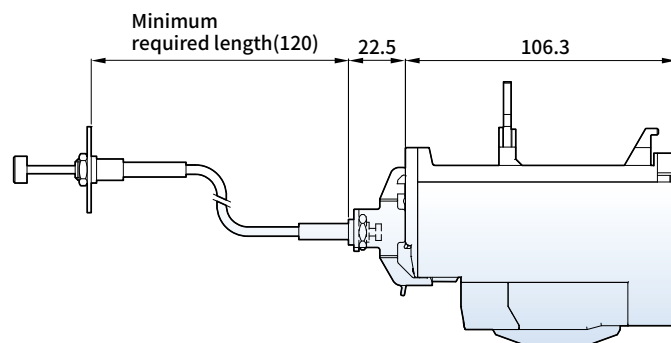

MT-150

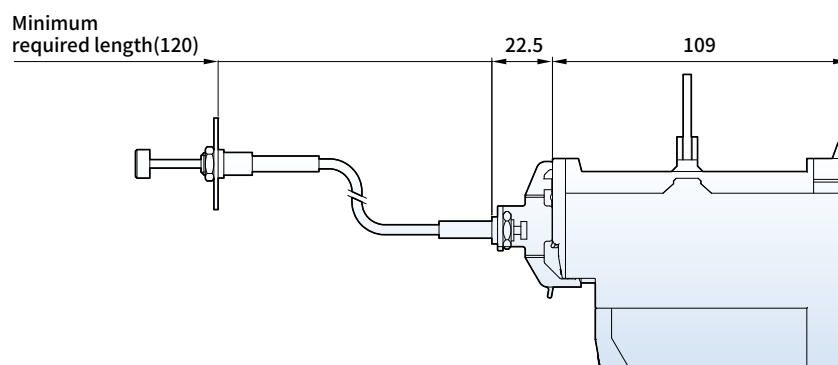

MT-225

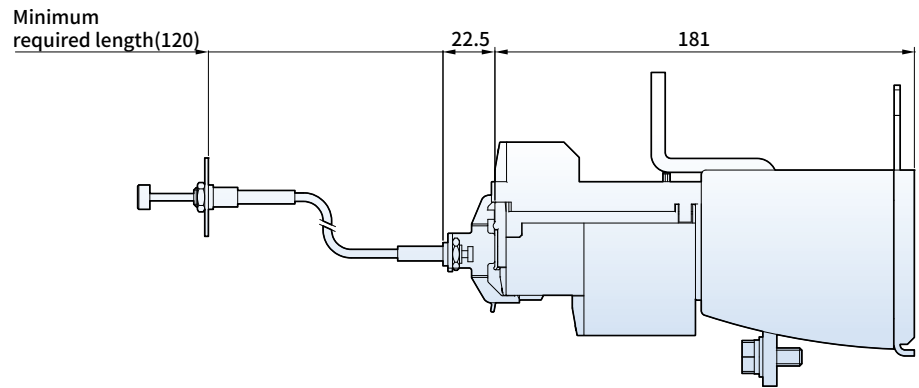

MT-400

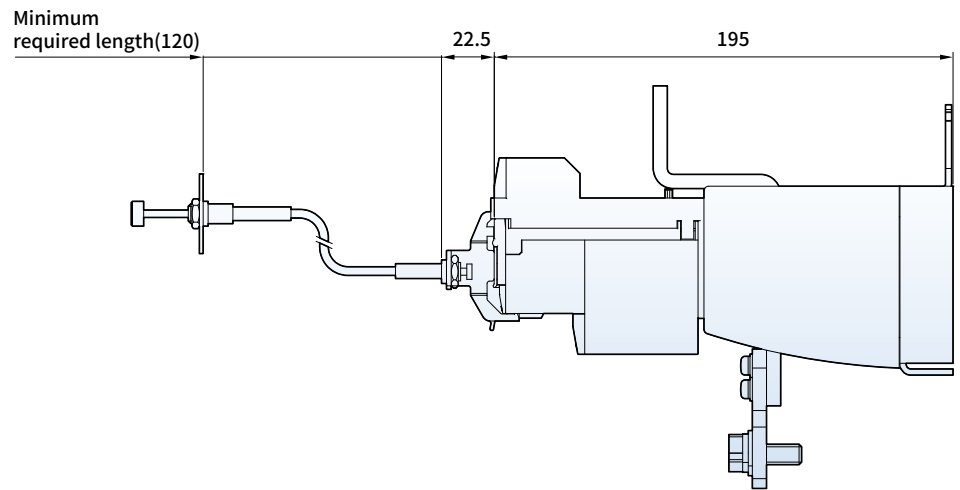

MT-800

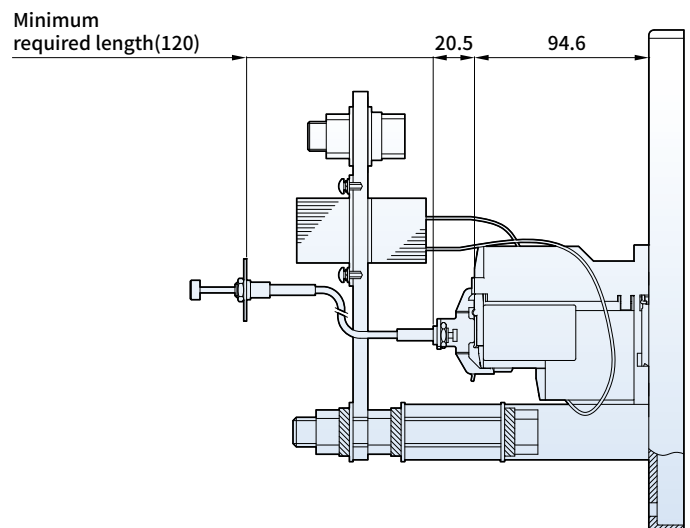

Overload relay ordering types

Trip class 10A



MT-12/□

MT-12 (Terminal type: Screw / Degree of protection: IP20)

| Setting range (A) | Ordering type | | | Contactor | Separate mounting unit |
|-------------------|--------------------------------|--------------------------------|--------------|------------------------------------|------------------------|
| | Non-differential (3P-2 heater) | Non-differential (3P-3 heater) | Differential | | |
| 0.1~0.16 | MT-12/2H0.14 | MT-12/3H0.14 | MT-12/3K0.14 | MC-6a MC-9a MC-12a MC-18a | UZ-12 |
| 0.16~0.25 | MT-12/2H0.21 | MT-12/3H0.21 | MT-12/3K0.21 | | |
| 0.25~0.4 | MT-12/2H0.33 | MT-12/3H0.33 | MT-12/3K0.33 | | |
| 0.4~0.63 | MT-12/2H0.52 | MT-12/3H0.52 | MT-12/3K0.52 | | |
| 0.63~1 | MT-12/2H0.82 | MT-12/3H0.82 | MT-12/3K0.82 | | |
| 1~1.6 | MT-12/2H1.3 | MT-12/3H1.3 | MT-12/3K1.3 | | |
| 1.6~2.5 | MT-12/2H2.1 | MT-12/3H2.1 | MT-12/3K2.1 | | |
| 2.5~4 | MT-12/2H3.3 | MT-12/3H3.3 | MT-12/3K3.3 | | |
| 4~6 | MT-12/2H5 | MT-12/3H5 | MT-12/3K5 | | |
| 5~8 | MT-12/2H6.5 | MT-12/3H6.5 | MT-12/3K6.5 | | |
| 6~9 | MT-12/2H7.5 | MT-12/3H7.5 | MT-12/3K7.5 | | |
| 7~10 | MT-12/2H8.5 | MT-12/3H8.5 | MT-12/3K8.5 | | |
| 9~13 | MT-12/2H11 | MT-12/3H11 | MT-12/3K11 | | |
| 12~18 | MT-12/2H15 | MT-12/3H15 | MT-12/3K15 | | |



MT-32/□

MT-32 (Terminal type: Screw / Degree of protection: IP20)

| Setting range (A) | Ordering type | | | Contactor | Separate mounting unit |
|-------------------|--------------------------------|--------------------------------|--------------|---|------------------------|
| | Non-differential (3P-2 heater) | Non-differential (3P-3 heater) | Differential | | |
| 0.1~0.16 | MT-32/2H0.14 | MT-32/3H0.14 | MT-32/3K0.14 | MC-9b MC-12b MC-18b MC-22b MC-32a MC-40a | UZ-32 |
| 0.16~0.25 | MT-32/2H0.21 | MT-32/3H0.21 | MT-32/3K0.21 | | |
| 0.25~0.4 | MT-32/2H0.33 | MT-32/3H0.33 | MT-32/3K0.33 | | |
| 0.4~0.63 | MT-32/2H0.52 | MT-32/3H0.52 | MT-32/3K0.52 | | |
| 0.63~1 | MT-32/2H0.82 | MT-32/3H0.82 | MT-32/3K0.82 | | |
| 1~1.6 | MT-32/2H1.3 | MT-32/3H1.3 | MT-32/3K1.3 | | |
| 1.6~2.5 | MT-32/2H2.1 | MT-32/3H2.1 | MT-32/3K2.1 | | |
| 2.5~4 | MT-32/2H3.3 | MT-32/3H3.3 | MT-32/3K3.3 | | |
| 4~6 | MT-32/2H5 | MT-32/3H5 | MT-32/3K5 | | |
| 5~8 | MT-32/2H6.5 | MT-32/3H6.5 | MT-32/3K6.5 | | |
| 6~9 | MT-32/2H7.5 | MT-32/3H7.5 | MT-32/3K7.5 | | |
| 7~10 | MT-32/2H8.5 | MT-32/3H8.5 | MT-32/3K8.5 | | |
| 9~13 | MT-32/2H11 | MT-32/3H11 | MT-32/3K11 | | |
| 12~18 | MT-32/2H15 | MT-32/3H15 | MT-32/3K15 | | |
| 16~22 | MT-32/2H19 | MT-32/3H19 | MT-32/3K19 | | |
| 18~25 | MT-32/2H21.5 | MT-32/3H21.5 | MT-32/3K21.5 | | |
| 22~32 | MT-32/2H27 | MT-32/3H27 | MT-32/3K27 | | |
| 28~40 | MT-32/2H34 | MT-32/3H34 | MT-32/3K34 | | UZ-32(34A) |



MT-63/CS



MT-63/CL

MT-63 (Terminal type: Screw(S), Lug(L) / Degree of protection: IP20)

| Setting range (A) | Ordering type | | | Contactor | Separate mounting unit |
|-------------------|--------------------------------|--------------------------------|-----------------|------------------|------------------------|
| | Non-differential (3P-2 heater) | Non-differential (3P-3 heater) | Differential | | |
| 4-6 | MT-63/2H5S/L | MT-63/3H5S/L | MT-63/3K5S/L | MC-50a MC-65a | UZ-63S/L |
| 5-8 | MT-63/2H6.5S/L | MT-63/3H6.5S/L | MT-63/3K6.5S/L | | |
| 6-9 | MT-63/2H7.5S/L | MT-63/3H7.5S/L | MT-63/3K7.5S/L | | |
| 7-10 | MT-63/2H8.5S/L | MT-63/3H8.5S/L | MT-63/3K8.5S/L | | |
| 9-13 | MT-63/2H11S/L | MT-63/3H11S/L | MT-63/3K11S/L | | |
| 12-18 | MT-63/2H15S/L | MT-63/3H15S/L | MT-63/3K15S/L | | |
| 16-22 | MT-63/2H19S/L | MT-63/3H19S/L | MT-63/3K19S/L | | |
| 18-25 | MT-63/2H21.5S/L | MT-63/3H21.5S/L | MT-63/3K21.5S/L | | |
| 24-36 | MT-63/2H30S/L | MT-63/3H30S/L | MT-63/3K30S/L | | |
| 28-40 | MT-63/2H34S/L | MT-63/3H34S/L | MT-63/3K34S/L | | |
| 34-50 | MT-63/2H42S/L | MT-63/3H42S/L | MT-63/3K42S/L | | |
| 45-65 | MT-63/2H55S/L | MT-63/3H55S/L | MT-63/3K55S/L | | |



MT-95/CS



MT-95/CL

MT-95 (Terminal type: Screw(S), Lug(L) / Degree of protection: IP20)

| Setting range (A) | Ordering type | | | Contactor | Separate mounting unit |
|-------------------|--------------------------------|--------------------------------|-----------------|-----------------------------|------------------------|
| | Non-differential (3P-2 heater) | Non-differential (3P-3 heater) | Differential | | |
| 7-10 | MT-95/2H8.5S/L | MT-95/3H8.5S/L | MT-95/3K8.5S/L | MC-75a MC-85a MC-100a | UZ-95S/L |
| 9-13 | MT-95/2H11S/L | MT-95/3H11S/L | MT-95/3K11S/L | | |
| 12-18 | MT-95/2H15S/L | MT-95/3H15S/L | MT-95/3K15S/L | | |
| 16-22 | MT-95/2H19S/L | MT-95/3H19S/L | MT-95/3K19S/L | | |
| 18-25 | MT-95/2H21.5S/L | MT-95/3H21.5S/L | MT-95/3K21.5S/L | | |
| 24-36 | MT-95/2H30S/L | MT-95/3H30S/L | MT-95/3K30S/L | | |
| 28-40 | MT-95/2H34S/L | MT-95/3H34S/L | MT-95/3K34S/L | | |
| 34-50 | MT-95/2H42S/L | MT-95/3H42S/L | MT-95/3K42S/L | | |
| 45-65 | MT-95/2H55S/L | MT-95/3H55S/L | MT-95/3K55S/L | | |
| 54-75 | MT-95/2H65S/L | MT-95/3H65S/L | MT-95/3K65S/L | | |
| 63-85 | MT-95/2H74S/L | MT-95/3H74S/L | MT-95/3K74S/L | | |
| 70-95 | MT-95/2H83S/L | MT-95/3H83S/L | MT-95/3K83S/L | | |
| 80-100 | MT-95/2H90S/L | MT-95/3H90S/L | MT-95/3K90S/L | | |



MT-150/□

MT-150 (Terminal type: Screw(S), Lug(L) / Degree of protection: IP20)

| Setting range (A) | Ordering type | | | Contactor | Separate mounting unit |
|-------------------|--------------------------------|--------------------------------|-----------------|--------------------|------------------------|
| | Non-differential (3P-2 heater) | Non-differential (3P-3 heater) | Differential | | |
| 34-50 | MT-150/2H42S/L | MT-150/3H42S/L | MT-150/3K42S/L | MC-130a MC-150a | UZ-150S/L |
| 45-65 | MT-150/2H55S/L | MT-150/3H55S/L | MT-150/3K55S/L | | |
| 54-75 | MT-150/2H65S/L | MT-150/3H65S/L | MT-150/3K65S/L | | |
| 63-85 | MT-150/2H74S/L | MT-150/3H74S/L | MT-150/3K74S/L | | |
| 80-105 | MT-150/2H93S/L | MT-150/3H93S/L | MT-150/3K93S/L | | |
| 95-130 | MT-150/2H113S/L | MT-150/3H113S/L | MT-150/3K113S/L | | |
| 110-150 | MT-150/2H130S/L | MT-150/3H130S/L | MT-150/3K130S/L | | |

Overload relay ordering types

Trip class 10A



MT-225/□

MT-225 (Terminal type: Screw / Degree of protection: IP20)

| Setting range (A) | Ordering type | | | Contactor | Remarks |
|-------------------|--------------------------------|--------------------------------|--------------|--------------------|---------|
| | Non-differential (3P-2 heater) | Non-differential (3P-3 heater) | Differential | | |
| 65~100 | MT-225/2H80 | MT-225/3H80 | MT-225/3K80 | MC-185a MC-225a | - |
| 85~125 | MT-225/2H107 | MT-225/3H107 | MT-225/3K107 | | |
| 100~160 | MT-225/2H130 | MT-225/3H130 | MT-225/3K130 | | |
| 120~185 | MT-225/2H153 | MT-225/3H153 | MT-225/3K153 | | |
| 160~240 | MT-225/2H200 | MT-225/3H200 | MT-225/3K200 | | |



MT-400/□

MT-400 (Terminal type: Screw / Degree of protection: IP20)

| Setting range (A) | Ordering type | | | Contactor | Remarks |
|-------------------|--------------------------------|--------------------------------|--------------|-------------------------------|---------|
| | Non-differential (3P-2 heater) | Non-differential (3P-3 heater) | Differential | | |
| 85~125 | MT-400/2H107 | MT-400/3H107 | MT-400/3K107 | MC-265a MC-330a MC-400a | - |
| 100~160 | MT-400/2H130 | MT-400/3H130 | MT-400/3K130 | | |
| 120~185 | MT-400/2H153 | MT-400/3H153 | MT-400/3K153 | | |
| 160~240 | MT-400/2H200 | MT-400/3H200 | MT-400/3K200 | | |
| 200~330 | MT-400/2H265 | MT-400/3H265 | MT-400/3K265 | | |
| 260~400 | MT-400/2H350 | MT-400/3H350 | MT-400/3K350 | | |



MT-800/□

MT-800 (Terminal type: Screw / Degree of protection: IP20)

| Setting range (A) | Ordering type | | | Contactor | Remarks |
|-------------------|--------------------------------|--------------------------------|--------------|-------------------------------|---------|
| | Non-differential (3P-2 heater) | Non-differential (3P-3 heater) | Differential | | |
| 200~330 | MT-800/2H265 | MT-800/3H265 | MT-800/3K265 | MC-500a MC-630a MC-800a | - |
| 260~400 | MT-800/2H350 | MT-800/3H350 | MT-800/3K350 | | |
| 400~630 | MT-800/2H515 | MT-800/3H515 | MT-800/3K515 | | |
| 520~800 | MT-800/2H660 | MT-800/3H660 | MT-800/3K660 | | |

Trip class 20A



MT-12/3D□

MT-12 (Terminal type: Screw / Degree of protection: IP20)

| Setting range (A) | Ordering type | Contactor | Separate mounting unit |
|-------------------|---------------|------------------------------------|------------------------|
| | Differential | | |
| 1~1.6 | MT-12/3D1.3 | MC-6a MC-9a MC-12a MC-18a | UZ-12 |
| 1.6~2.5 | MT-12/3D2.1 | | |
| 2.5~4 | MT-12/3D3.3 | | |
| 4~6 | MT-12/3D5 | | |
| 5~8 | MT-12/3D6.5 | | |
| 6~9 | MT-12/3D7.5 | | |
| 7~10 | MT-12/3D8.5 | | |
| 9~13 | MT-12/3D11 | | |
| 12~18 | MT-12/3D15 | | |



MT-32/3D□

MT-32 (Terminal type: Screw / Degree of protection: IP20)

| Setting range (A) | Ordering type | Contactor | Separate mounting unit |
|-------------------|---------------|---|------------------------|
| | Differential | | |
| 1~1.6 | MT-32/3D1.3 | MC-9b MC-12b MC-18b MC-22b MC-32a MC-40a | UZ-32 |
| 1.6~2.5 | MT-32/3D2.1 | | |
| 2.5~4 | MT-32/3D3.3 | | |
| 4~6 | MT-32/3D5 | | |
| 5~8 | MT-32/3D6.5 | | |
| 6~9 | MT-32/3D7.5 | | |
| 7~10 | MT-32/3D8.5 | | |
| 9~13 | MT-32/3D11 | | |
| 12~18 | MT-32/3D15 | | |
| 16~22 | MT-32/3D19 | | |
| 18~25 | MT-32/3D21.5 | | |
| 22~32 | MT-32/3D27 | | |
| 28~40 | MT-32/3D34 | | |

Overload relay ordering types

Trip class 20A



MT-63/ S



MT-63/ L

MT-63 (Terminal type: Screw(S), Lug(L) / Degree of protection: IP20)

| Setting range (A) | Ordering type | Contactor | Separate mounting unit |
|-------------------|-----------------|------------------|------------------------|
| | Differential | | |
| 4~6 | MT-63/3D5S/L | MC-50a MC-65a | UZ-63S/L |
| 5~8 | MT-63/3D6.5S/L | | |
| 6~9 | MT-63/3D7.5S/L | | |
| 7~10 | MT-63/3D8.5S/L | | |
| 9~13 | MT-63/3D11S/L | | |
| 12~18 | MT-63/3D15S/L | | |
| 16~22 | MT-63/3D19S/L | | |
| 18~25 | MT-63/3D21.5S/L | | |
| 24~36 | MT-63/3D30S/L | | |
| 28~40 | MT-63/3D34S/L | | |
| 34~50 | MT-63/3D42S/L | | |
| 45~65 | MT-63/3D55S/L | | |

MT-95 (Terminal type: Screw(S), Lug(L) / Degree of protection: IP20)



MT-95/ S



MT-95/ L

| Setting range (A) | Ordering type | Contactor | Separate mounting unit |
|-------------------|-----------------|-----------------------------|------------------------|
| | Differential | | |
| 7~10 | MT-95/3D8.5S/L | MC-75a MC-85a MC-100a | UZ-95S/L |
| 9~13 | MT-95/3D11S/L | | |
| 12~18 | MT-95/3DK15S/L | | |
| 16~22 | MT-95/3D19S/L | | |
| 18~25 | MT-95/3D21.5S/L | | |
| 24~36 | MT-95/3D30S/L | | |
| 28~40 | MT-95/3D34S/L | | |
| 34~50 | MT-95/3D42S/L | | |
| 45~65 | MT-95/3D55S/L | | |
| 54~75 | MT-95/3D65S/L | | |
| 63~85 | MT-95/3D74S/L | | |
| 70~95 | MT-95/3D83S/L | | |
| 80~100 | MT-95/3D90S/L | | |

MT-150 (Terminal type: Screw(S), Lug(L) / Degree of protection: IP20)



MT-150/ S

| Setting range (A) | Ordering type | Contactor | Separate mounting unit |
|-------------------|-----------------|--------------------|------------------------|
| | Differential | | |
| 34~50 | MT-150/3D42S/L | MC-130a MC-150a | UZ-150S/L |
| 45~65 | MT-150/3D55S/L | | |
| 54~75 | MT-150/3D65S/L | | |
| 63~85 | MT-150/3D74S/L | | |
| 80~105 | MT-150/3D93S/L | | |
| 95~130 | MT-150/3D113S/L | | |
| 110~150 | MT-150/3D130S/L | | |



MT-225/3D

MT-225 (Terminal type: Screw / Degree of protection: IP20)

| Setting range (A) | Ordering type | Contactor | Remarks |
|-------------------|---------------|--------------------|---------|
| | Differential | | |
| 65~100 | MT-225/3D80 | MC-185a MC-225a | - |
| 85~125 | MT-225/3D107 | | |
| 100~160 | MT-225/3D130 | | |
| 120~185 | MT-225/3D153 | | |
| 160~240 | MT-225/3D200 | | |



MT-400/3D

MT-400 (Terminal type: Screw / Degree of protection: IP20)

| Setting range (A) | Ordering type | Contactor | Remarks |
|-------------------|---------------|-------------------------------|---------|
| | Differential | | |
| 85~125 | MT-400/3D107 | MC-265a MC-330a MC-400a | - |
| 100~160 | MT-400/3D130 | | |
| 120~185 | MT-400/3D153 | | |
| 160~240 | MT-400/3D200 | | |
| 200~330 | MT-400/3D265 | | |
| 260~400 | MT-400/3D350 | | |



MT-800/3D

MT-800 (Terminal type: Screw / Degree of protection: IP20)

| Setting range (A) | Ordering type | Contactor | Remarks |
|-------------------|---------------|-------------------------------|---------|
| | Differential | | |
| 200~330 | MT-800/3D265 | MC-500a MC-630a MC-800a | - |
| 260~400 | MT-800/3D350 | | |
| 400~630 | MT-800/3D515 | | |
| 520~800 | MT-800/3D660 | | |

Overload relay trip curves

Class 10A, 18AF

- MT-12/2H
- MT-12/3H
- MT-12/3K

Cold starting

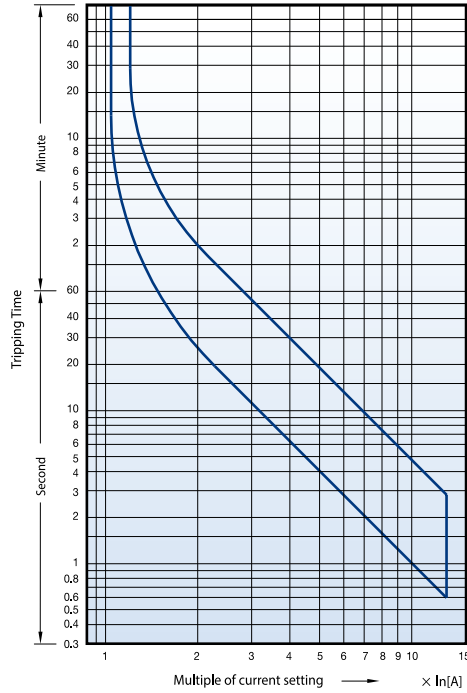

Hot starting

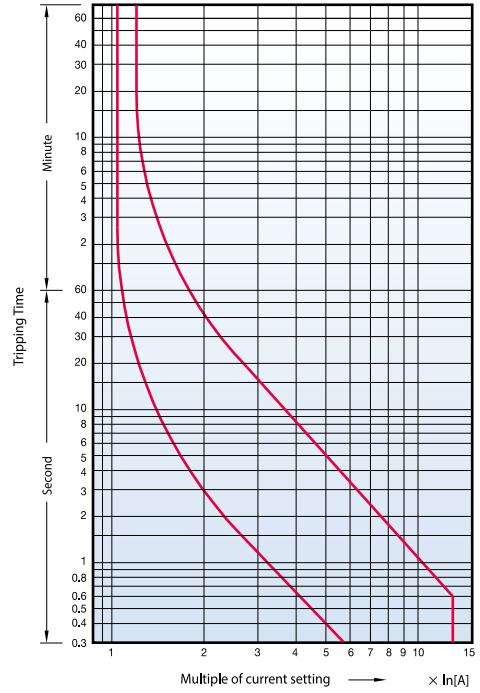

Class 20, 18AF

- MT-12/3D

Cold starting

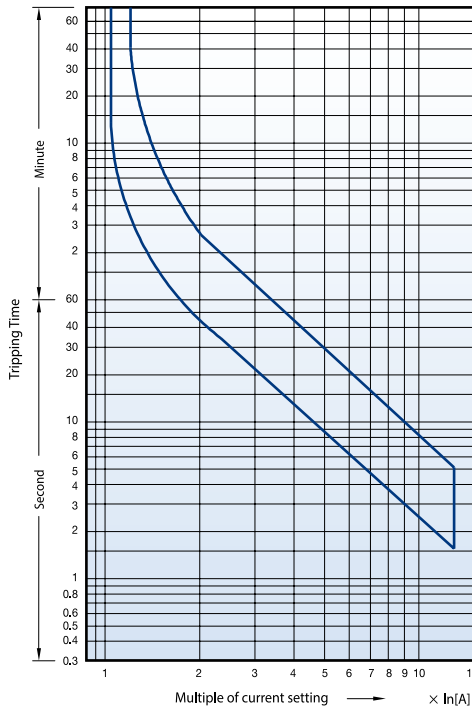

Hot starting

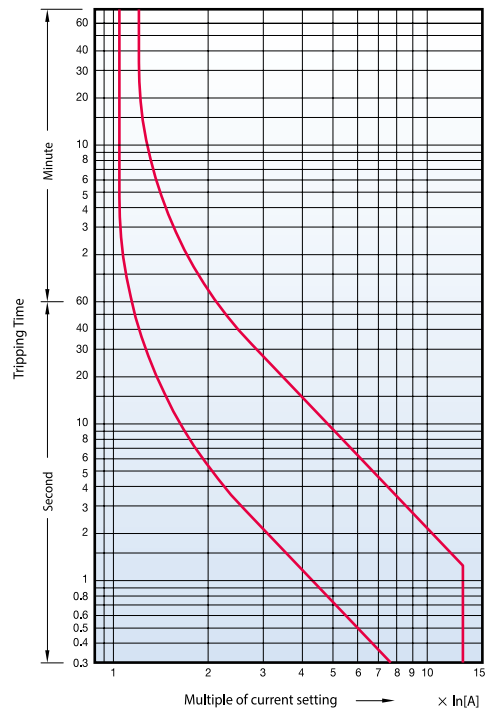

Class 10A, 40AF

- MT-32/2H
- MT-32/3H
- MT-32/3K

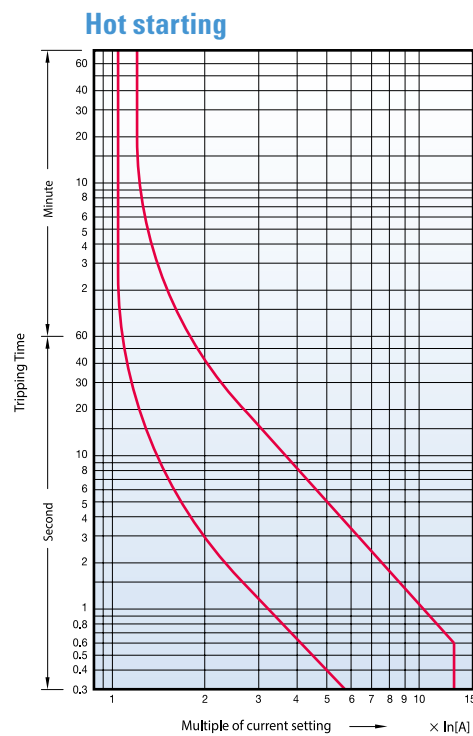
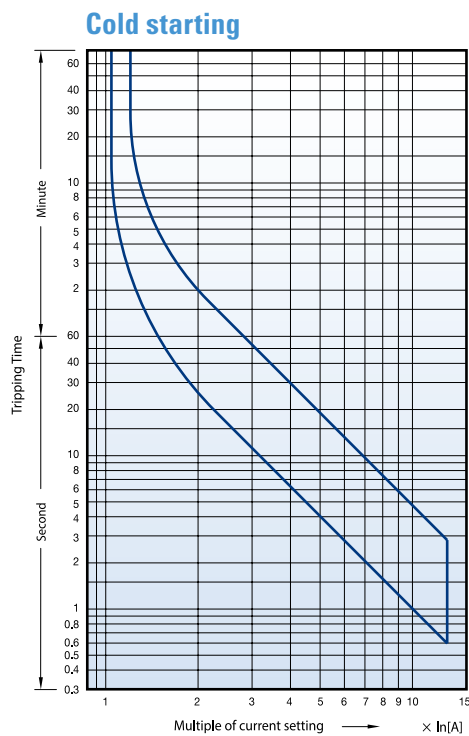

Class 20, 40AF

- MT-32/3D

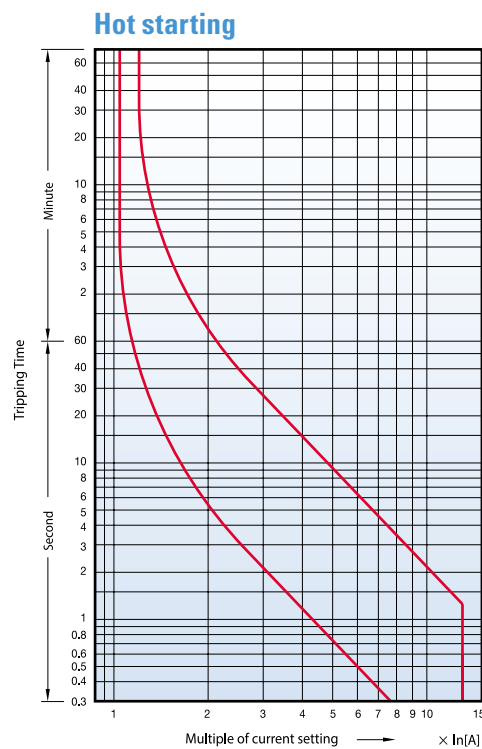
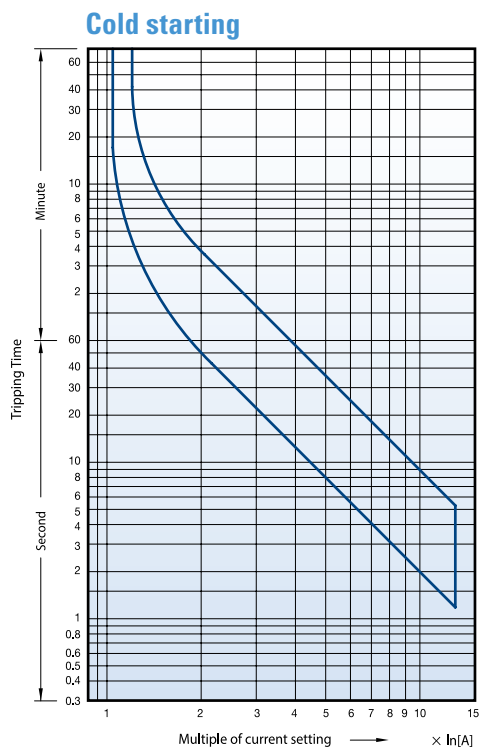

Overload relay trip curves

Class 10A, 65AF

- MT-63/2H
- MT-63/3H
- MT-63/3K

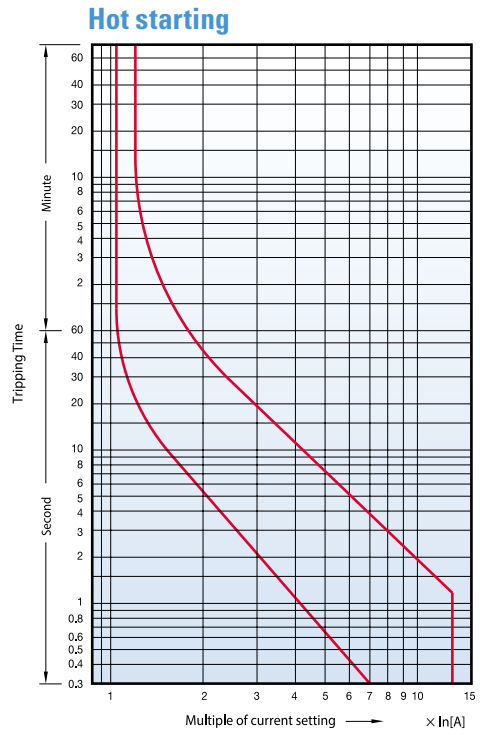
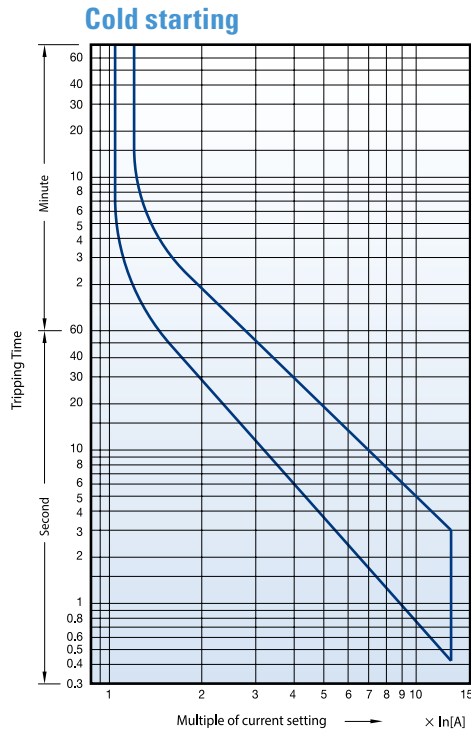

Class 20, 65AF

- MT-63/3D

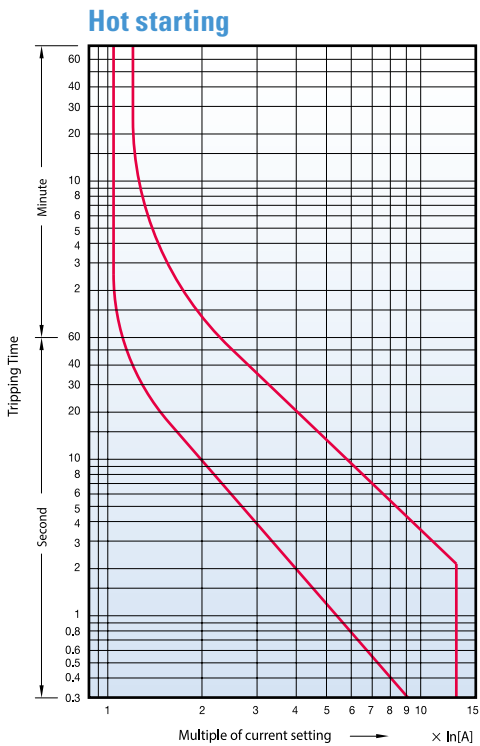
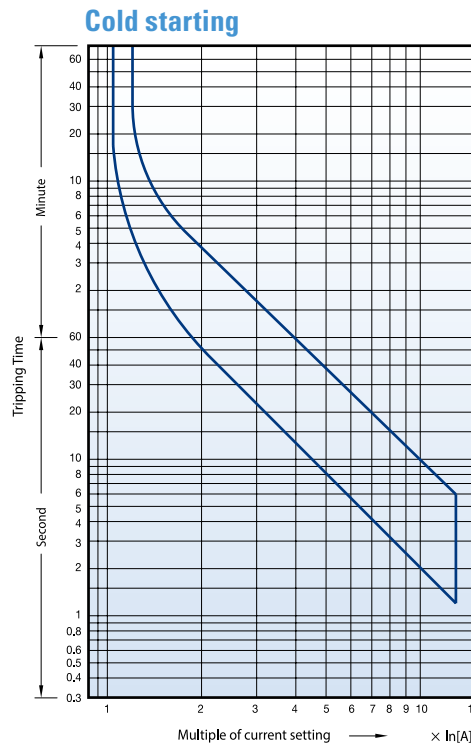

Class 10A, 100AF

- MT-95/2H
- MT-95/3H
- MT-95/3K

Cold starting

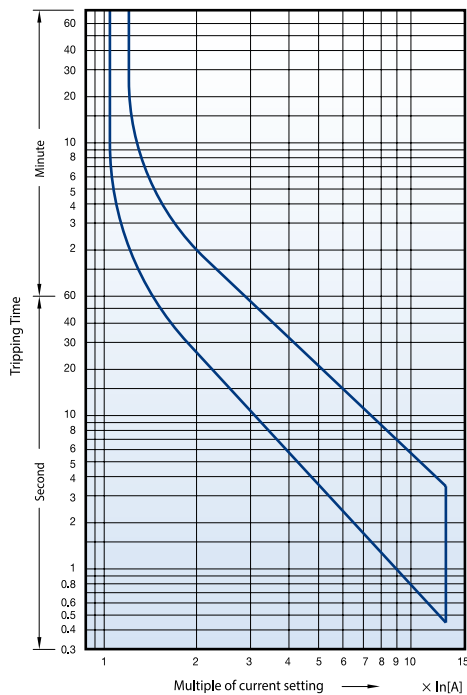

Hot starting

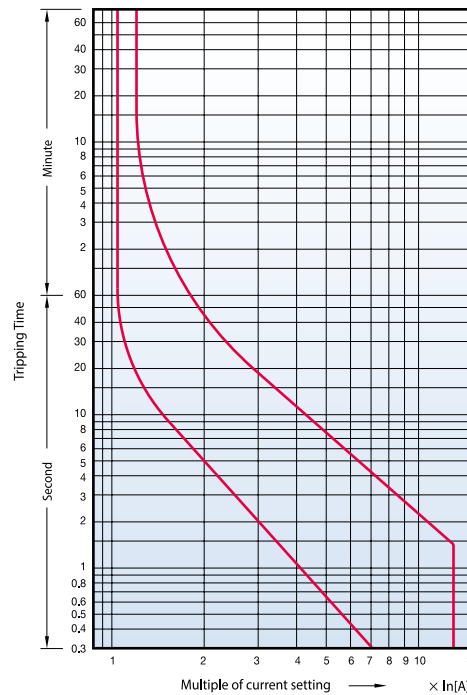

Class 20, 100AF

- MT-95/3D

Cold starting

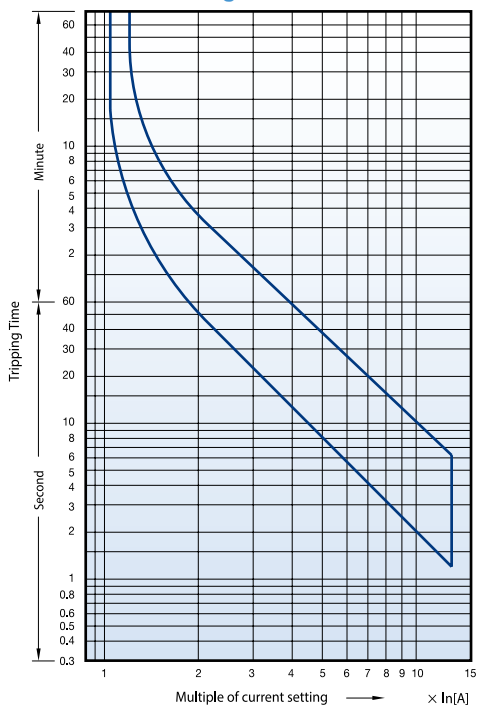

Hot starting

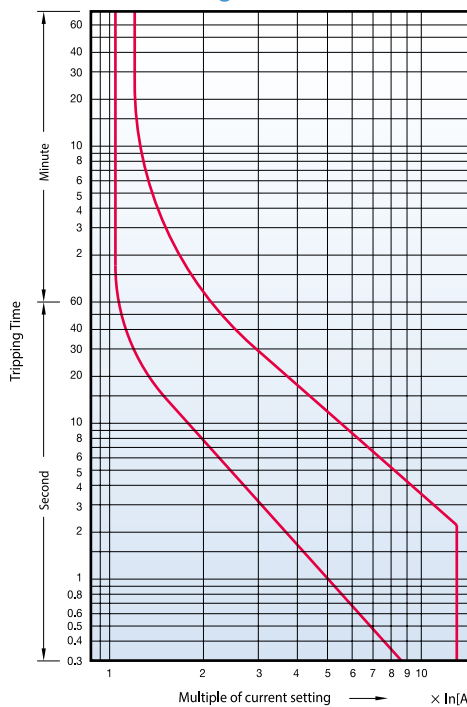

Overload relay trip curves

Class 10A, 150AF

- MT-150/2H
- MT-150/3H
- MT-150/3K

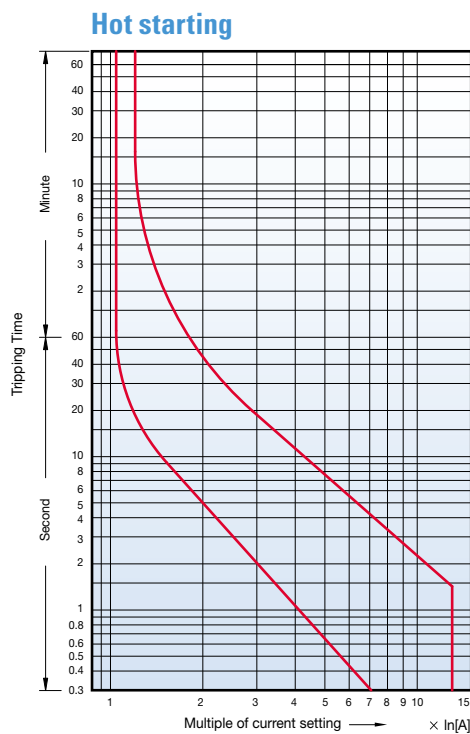
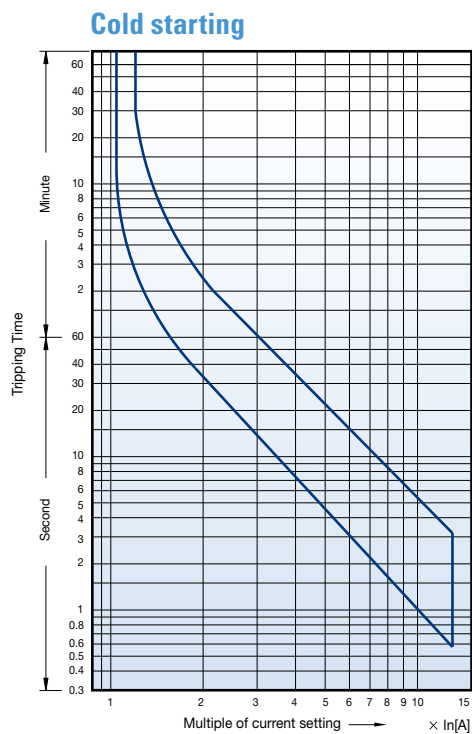

Class 20, 150AF

- MT-150/3D

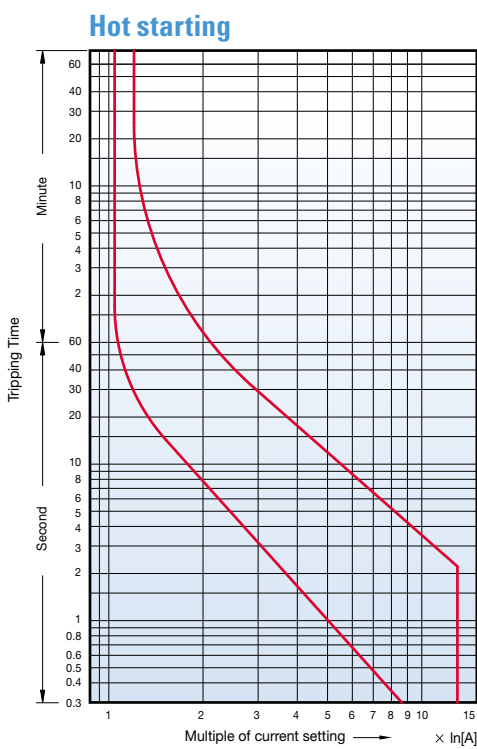
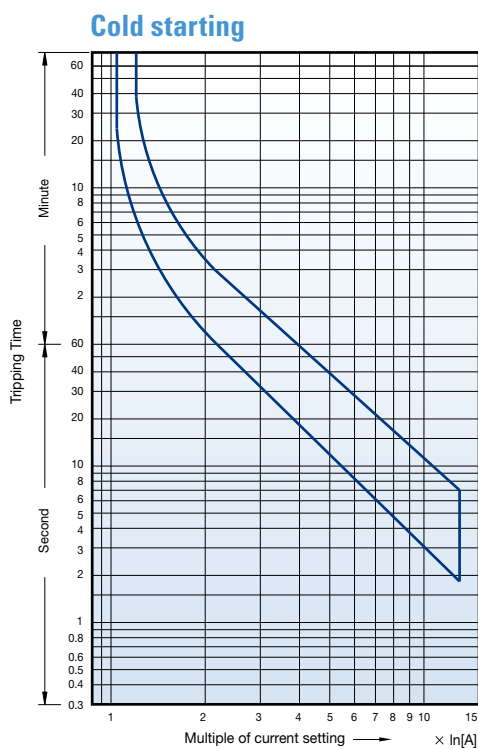

Class 10A, 225AF

- MT-225/2H
- MT-225/3H
- MT-225/3K

Cold starting

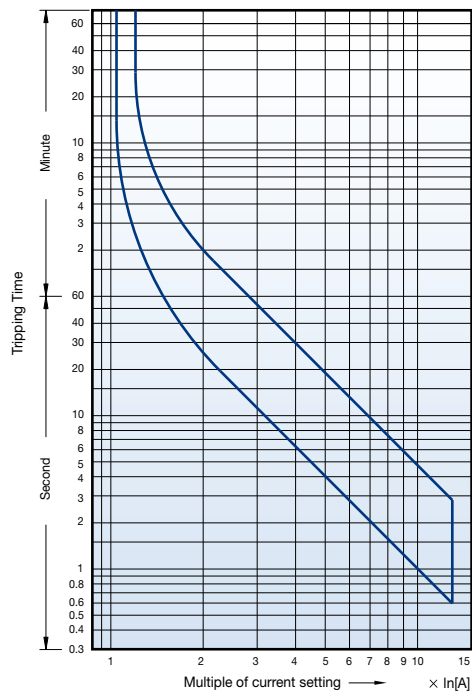

Hot starting

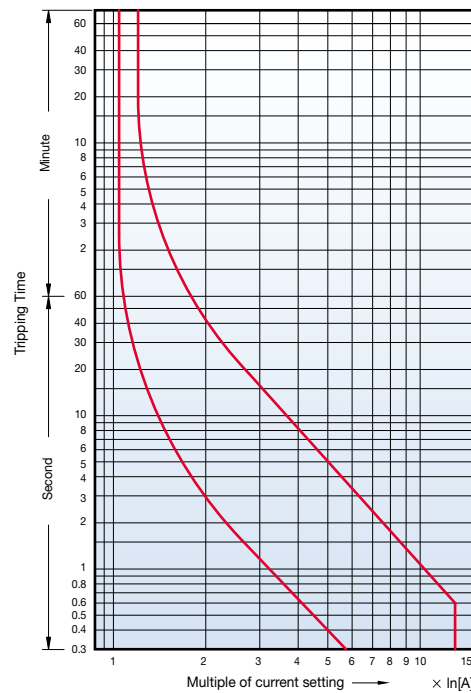

Class 20, 225AF

- MT-225/3D

Cold starting

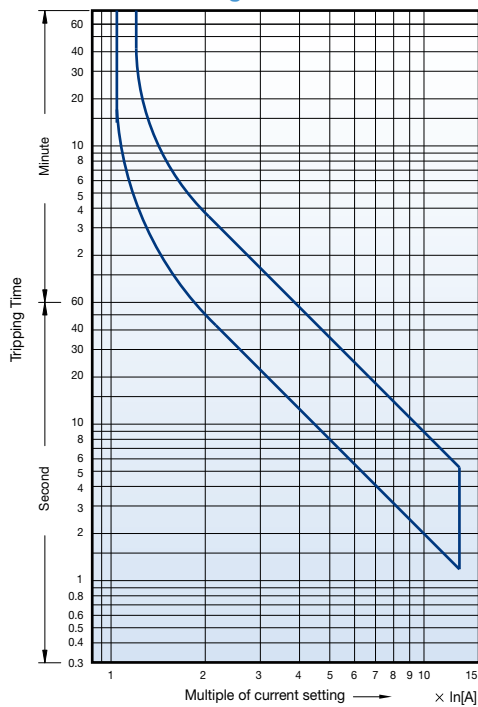

Hot starting

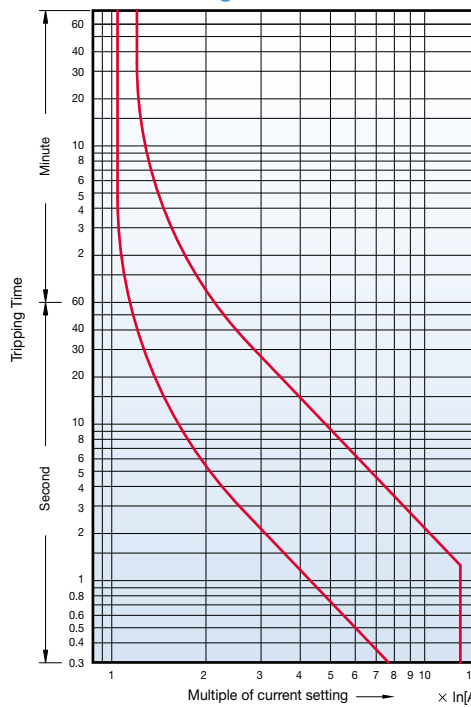

Overload relay trip curves

Class 10A, 400AF

- MT-400/2H
- MT-400/3H
- MT-400/3K

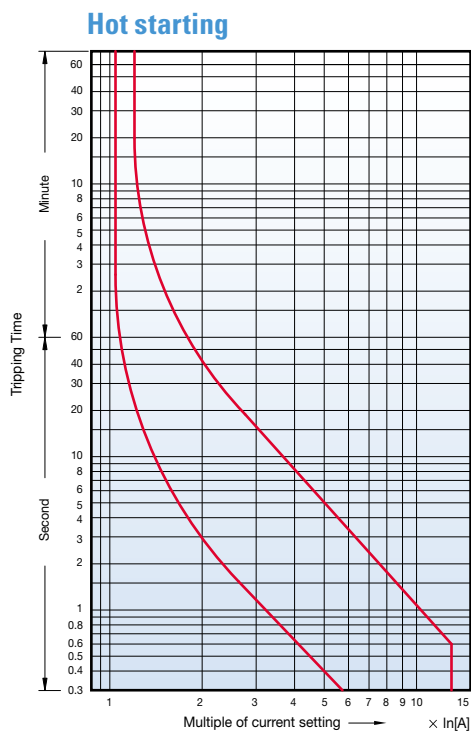
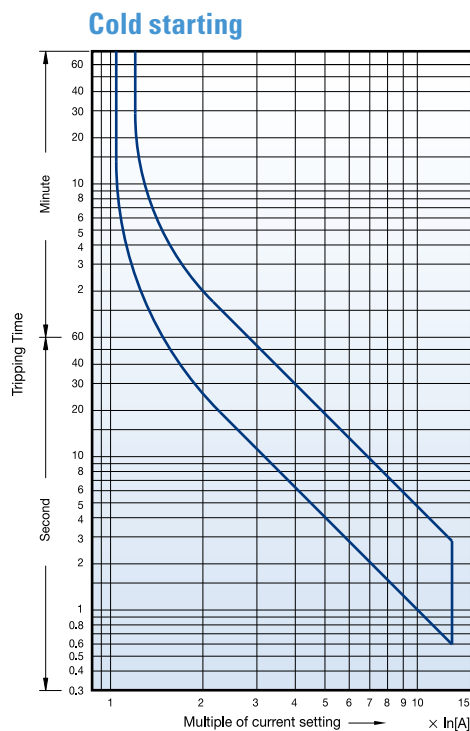

Class 20, 400AF

- MT-400/3D

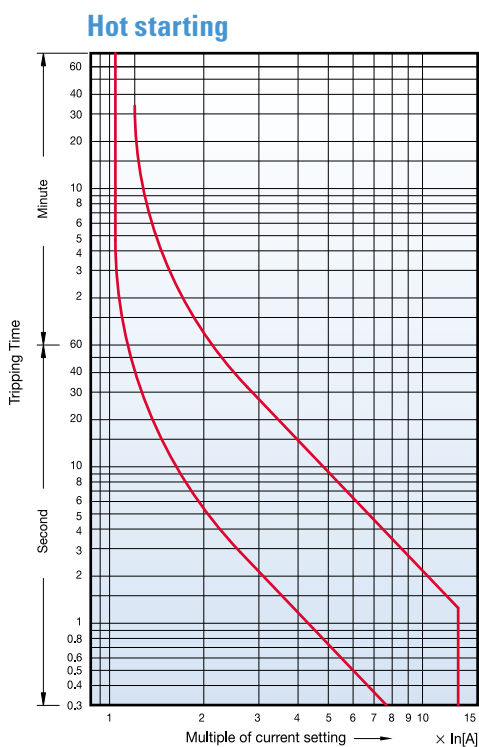
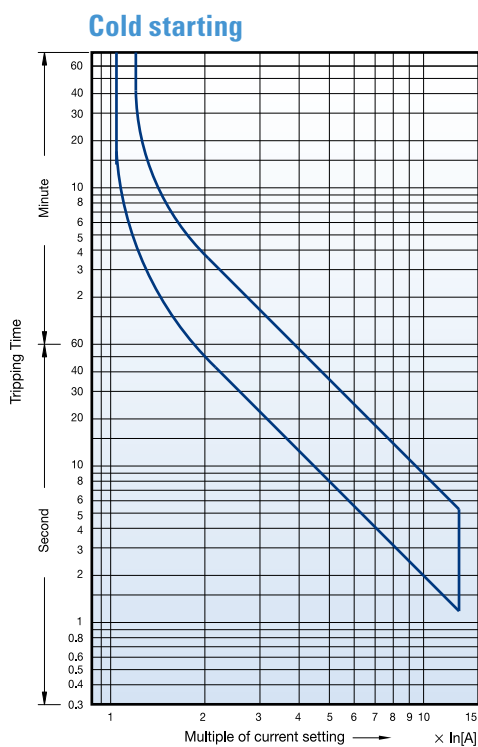

Class 10A, 800AF

- MT-800/2H
- MT-800/3H
- MT-800/3K

Cold starting

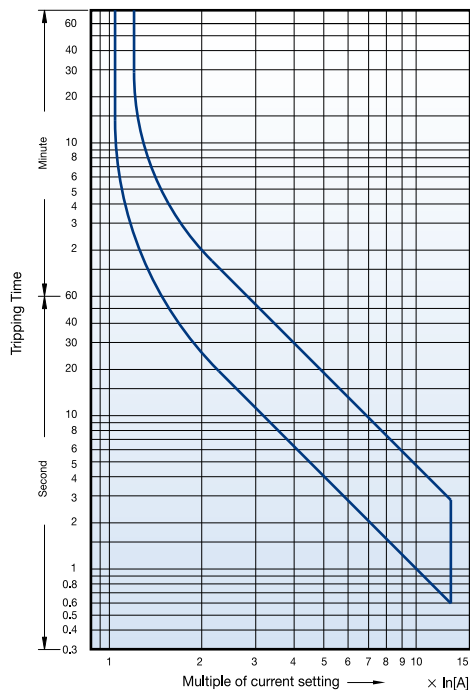

Hot starting

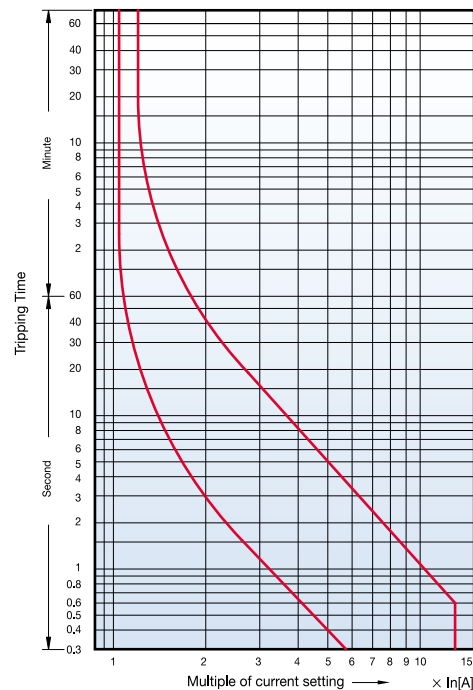

Class 20, 800AF

- MT-800/3D

Cold starting

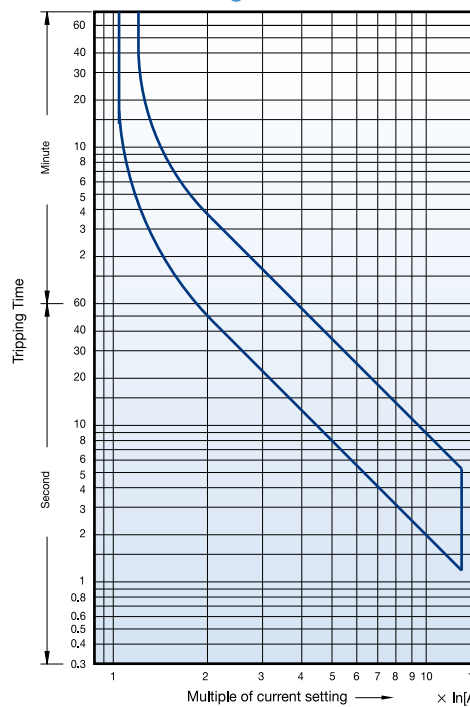

Hot starting

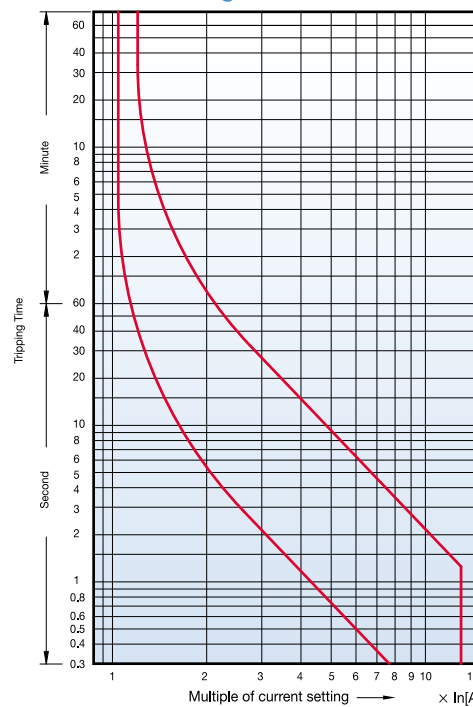

Type 2 coordination

440V

Susol MCCB N-type

| Rated operational power | | Circuit breaker | | Contactor | Thermal overload relays | | Short circuit breaking capacity | |
|-------------------------|-------------|-----------------|------------|-----------|-------------------------|-------------------|---------------------------------|---------|
| kW | Current [A] | Type | Rating [A] | Type | Type | Setting range [A] | Ir [kA] | Iq [kA] |
| | 440V | | | | | | | |
| 1.1 | 2.37 | TS100N | 16 | MC-12b | MT-32 | 2.5~4 | 1 | 50 |
| 1.5 | 3.06 | TS100N | 16 | MC-18b | MT-32 | 2.5~4 | 1 | 50 |
| 2.2 | 4.42 | TS100N | 16 | MC-22b | MT-32 | 4~6 | 1 | 50 |
| 3 | 5.77 | TS100N | 16 | MC-22b | MT-32 | 5~8 | 1 | 50 |
| 4 | 7.90 | TS100N | 16 | MC-32a | MT-32 | 6~9 | 1 | 50 |
| 5.5 | 10.40 | TS100N | 16 | MC-32a | MT-32 | 9~13 | 3 | 50 |
| 7.5 | 13.70 | TS100N | 20 | MC-32a | MT-32 | 12~18 | 3 | 50 |
| 11 | 20.10 | TS100N | 32 | MC-40a | MT-32 | 18~25 | 3 | 50 |
| 15 | 26.50 | TS100N | 40 | MC-40a | MT-32 | 22~32 | 3 | 50 |
| 18.5 | 32.80 | TS100N | 40 | MC-50a | MT-63 | 28~40 | 3 | 50 |
| 22 | 39.00 | TS100N | 50 | MC-50a | MT-63 | 34~50 | 3 | 50 |
| 30 | 51.50 | TS100N | 63 | MC-65a | MT-63 | 45~65 | 3 | 50 |
| 37 | 64.00 | TS100N | 80 | MC-75a | MT-95 | 54~75 | 5 | 50 |
| 45 | 76.00 | TS100N | 100 | MC-85a | MT-95 | 63~85 | 5 | 50 |
| 55 | 90.00 | TS100N | 100 | MC-100a | MT-95 | 70~95 | 5 | 50 |
| 59 | 97.00 | TS160N | 100 | MC-130a | MT-150 | 80~105 | 5 | 50 |
| 75 | 125 | TS160N | 160 | MC-150a | MT-150 | 110~150 | 10 | 50 |
| 90 | 146 | TS160N | 160 | MC-185a | MT-225 | 120~185 | 10 | 50 |
| 110 | 178 | TS250N | 200 | MC-185a | MT-225 | 160~240 | 10 | 50 |
| 132 | 215 | TS250N | 250 | MC-225a | MT-225 | 160~240 | 10 | 65 |
| 160 | 256 | TS400N | 300 | MC-400a | MT-400 | 200~330 | 18 | 65 |
| 200 | 330 | TS400N | 400 | MC-400a | MT-400 | 260~400 | 18 | 65 |
| 220 | 353 | TS400N | 400 | MC-400a | MT-400 | 260~400 | 18 | 65 |
| 250 | 401 | TS630N | 500 | MC-630a | MT-800 | 260~400 | 18 | 65 |
| 300 | 481 | TS630N | 500 | MC-630a | MT-800 | 400~630 | 18 | 65 |

440V

Susol MCCB H-type

| Rated operational power | | Circuit breaker | | Contactor | Thermal overload relays | | Short circuit breaking capacity | |
|-------------------------|-------------|-----------------|------------|-----------|-------------------------|-------------------|---------------------------------|---------------------|
| kW | Current [A] | Type | Rating [A] | Type | Type | Setting range [A] | I _r [kA] | I _q [kA] |
| | 440V | | | | | | | |
| 1.1 | 2.37 | TS100H | 16 | MC-12b | MT-32 | 2.5~4 | 1 | 50 |
| 1.5 | 3.06 | TS100H | 16 | MC-18b | MT-32 | 2.5~4 | 1 | 50 |
| 2.2 | 4.42 | TS100H | 16 | MC-22b | MT-32 | 4~6 | 1 | 50 |
| 3 | 5.77 | TS100H | 16 | MC-22b | MT-32 | 5~8 | 1 | 50 |
| 4 | 7.90 | TS100H | 16 | MC-32a | MT-32 | 6~9 | 1 | 50 |
| 5.5 | 10.40 | TS100H | 16 | MC-32a | MT-32 | 9~13 | 3 | 50 |
| 7.5 | 13.70 | TS100H | 20 | MC-32a | MT-32 | 12~18 | 3 | 70 |
| 11 | 20.10 | TS100H | 32 | MC-40a | MT-32 | 18~25 | 3 | 70 |
| 15 | 26.50 | TS100H | 40 | MC-40a | MT-32 | 22~32 | 3 | 70 |
| 18.5 | 32.80 | TS100H | 40 | MC-50a | MT-63 | 28~40 | 3 | 70 |
| 22 | 39.00 | TS100H | 50 | MC-50a | MT-63 | 34~50 | 3 | 70 |
| 30 | 51.50 | TS100H | 63 | MC-65a | MT-63 | 45~65 | 3 | 70 |
| 37 | 64.00 | TS100H | 80 | MC-75a | MT-95 | 54~75 | 5 | 70 |
| 45 | 76.00 | TS100H | 100 | MC-85a | MT-95 | 63~85 | 5 | 70 |
| 55 | 90.00 | TS100H | 100 | MC-100a | MT-95 | 70~95 | 5 | 70 |
| 59 | 97.00 | TS160H | 100 | MC-130a | MT-150 | 80~105 | 5 | 70 |
| 75 | 125 | TS160H | 160 | MC-150a | MT-150 | 110~150 | 10 | 70 |
| 90 | 146 | TS160H | 160 | MC-185a | MT-225 | 120~185 | 10 | 70 |
| 110 | 178 | TS250H | 200 | MC-185a | MT-225 | 160~240 | 10 | 70 |
| 132 | 215 | TS250H | 250 | MC-225a | MT-225 | 160~240 | 10 | 70 |
| 160 | 256 | TS400H | 300 | MC-400a | MT-400 | 200~330 | 18 | 85 |
| 200 | 330 | TS400H | 400 | MC-400a | MT-400 | 260~400 | 18 | 85 |
| 220 | 353 | TS400H | 400 | MC-400a | MT-400 | 260~400 | 18 | 85 |
| 250 | 401 | TS630H | 500 | MC-630a | MT-800 | 260~400 | 18 | 85 |
| 300 | 481 | TS630H | 500 | MC-630a | MT-800 | 400~630 | 18 | 100 |

Type 2 Coordination

440V

Susol MCCB L-type

| Rated operational power | | Circuit breaker | | Contactor | Thermal overload relays | | Short circuit breaking capacity | |
|-------------------------|-------------|-----------------|------------|-----------|-------------------------|-------------------|---------------------------------|---------|
| kW | Current [A] | Type | Rating [A] | Type | Type | Setting range [A] | Ir [kA] | Iq [kA] |
| | 440V | | | | | | | |
| 1.1 | 2.37 | TS100L | 16 | MC-12b | MT-32 | 2.5~4 | 1 | 50 |
| 1.5 | 3.06 | TS100L | 16 | MC-18b | MT-32 | 2.5~4 | 1 | 50 |
| 2.2 | 4.42 | TS100L | 16 | MC-22b | MT-32 | 4~6 | 1 | 50 |
| 3 | 5.77 | TS100L | 16 | MC-22b | MT-32 | 5~8 | 1 | 50 |
| 4 | 7.90 | TS100L | 16 | MC-32a | MT-32 | 6~9 | 1 | 50 |
| 5.5 | 10.40 | TS100L | 16 | MC-32a | MT-32 | 9~13 | 3 | 50 |
| 7.5 | 13.70 | TS100L | 20 | MC-32a | MT-32 | 12~18 | 3 | 100 |
| 11 | 20.10 | TS100L | 32 | MC-40a | MT-32 | 18~25 | 3 | 100 |
| 15 | 26.50 | TS100L | 40 | MC-40a | MT-32 | 22~32 | 3 | 100 |
| 18.5 | 32.80 | TS100L | 40 | MC-50a | MT-63 | 28~40 | 3 | 130 |
| 22 | 39.00 | TS100L | 50 | MC-50a | MT-63 | 34~50 | 3 | 130 |
| 30 | 51.50 | TS100L | 63 | MC-65a | MT-63 | 45~65 | 3 | 130 |
| 37 | 64.00 | TS100L | 80 | MC-75a | MT-95 | 54~75 | 5 | 130 |
| 45 | 76.00 | TS100L | 100 | MC-85a | MT-95 | 63~85 | 5 | 130 |
| 55 | 90.00 | TS100L | 100 | MC-100a | MT-95 | 70~95 | 5 | 130 |
| 59 | 97.00 | TS160L | 100 | MC-130a | MT-150 | 80~105 | 5 | 130 |
| 75 | 125 | TS160L | 160 | MC-150a | MT-150 | 110~150 | 10 | 130 |
| 90 | 146 | TS160L | 160 | MC-185a | MT-225 | 120~185 | 10 | 130 |
| 110 | 178 | TS250L | 200 | MC-185a | MT-225 | 160~240 | 10 | 130 |
| 132 | 215 | TS250L | 250 | MC-225a | MT-225 | 160~240 | 10 | 130 |
| 160 | 256 | TS400L | 300 | MC-400a | MT-400 | 200~330 | 18 | 130 |
| 200 | 330 | TS400L | 400 | MC-400a | MT-400 | 260~400 | 18 | 130 |
| 220 | 353 | TS400L | 400 | MC-400a | MT-400 | 260~400 | 18 | 130 |
| 250 | 401 | TS630L | 500 | MC-630a | MT-800 | 260~400 | 18 | 130 |
| 300 | 481 | TS630L | 500 | MC-630a | MT-800 | 400~630 | 18 | 130 |

440V

Metasol MCCB N-type

| Rated operational power | | Circuit breaker | | Contactor | Thermal overload relays | | Short circuit breaking capacity | |
|-------------------------|-------------|-----------------|------------|-----------|-------------------------|-------------------|---------------------------------|---------------------|
| kW | Current [A] | Type | Rating [A] | Type | Type | Setting range [A] | I _r [kA] | I _q [kA] |
| | 440V | | | | | | | |
| 1.1 | 2.37 | ABN53c | 15 | MC-12b | MT-32 | 2.5~4 | 1 | 14 |
| 1.5 | 3.06 | ABN53c | 15 | MC-18b | MT-32 | 2.5~4 | 1 | 14 |
| 2.2 | 4.42 | ABN53c | 15 | MC-22b | MT-32 | 4~6 | 1 | 14 |
| 3.0 | 5.77 | ABN53c | 15 | MC-22b | MT-32 | 5~8 | 1 | 14 |
| 4.0 | 7.90 | ABN53c | 15 | MC-32a | MT-32 | 6~9 | 1 | 14 |
| 5.5 | 10.40 | ABN53c | 15 | MC-32a | MT-32 | 9~13 | 3 | 14 |
| 7.5 | 13.70 | ABN53c | 20 | MC-32a | MT-32 | 12~18 | 3 | 14 |
| 11.0 | 20.10 | ABN103c | 30 | MC-40a | MT-32 | 18~25 | 3 | 18 |
| 15.0 | 26.50 | ABN103c | 40 | MC-40a | MT-32 | 22~32 | 3 | 18 |
| 18.5 | 32.80 | ABN103c | 40 | MC-50a | MT-63 | 28~40 | 3 | 18 |
| 22.0 | 39.00 | ABN103c | 50 | MC-50a | MT-63 | 34~50 | 3 | 18 |
| 30.0 | 51.50 | ABN103c | 75 | MC-65a | MT-63 | 45~65 | 3 | 18 |
| 37.0 | 64.00 | ABN103c | 75 | MC-75a | MT-95 | 54~75 | 5 | 18 |
| 45.0 | 76.00 | ABN103c | 100 | MC-85a | MT-95 | 63~85 | 5 | 18 |
| 55.0 | 90.00 | ABN103c | 100 | MC-100a | MT-95 | 70~95 | 5 | 18 |
| 59.0 | 97.00 | ABN103c | 100 | MC-130a | MT-150 | 80~105 | 5 | 18 |
| 75.0 | 125 | ABN203c | 150 | MC-150a | MT-150 | 110~150 | 10 | 26 |
| 90.0 | 146 | ABN203c | 200 | MC-185a | MT-225 | 120~185 | 10 | 26 |
| 110.0 | 178 | ABN203c | 200 | MC-185a | MT-225 | 160~240 | 10 | 26 |
| 132.0 | 215 | ABN203c | 250 | MC-225a | MT-225 | 160~240 | 10 | 26 |
| 160.0 | 256 | ABN403c | 300 | MC-400a | MT-400 | 200~330 | 18 | 37 |
| 200.0 | 330 | ABN403c | 400 | MC-400a | MT-400 | 260~400 | 18 | 37 |
| 220.0 | 353 | ABN403c | 400 | MC-400a | MT-400 | 260~400 | 18 | 37 |
| 250.0 | 401 | ABN803c | 500 | MC-630a | MT-800 | 260~400 | 18 | 37 |
| 300.0 | 481 | ABN803c | 500 | MC-630a | MT-800 | 400~630 | 18 | 37 |

Type 2 Coordination

440V

Metasol MCCB S-type

| Rated operational power | | Circuit breaker | | Contactor | Thermal overload relays | | Short circuit breaking capacity | |
|-------------------------|-------------|-----------------|------------|-----------|-------------------------|-------------------|---------------------------------|---------|
| kW | Current [A] | Type | Rating [A] | Type | Type | Setting range [A] | Ir [kA] | Iq [kA] |
| | 440V | | | | | | | |
| 1.1 | 2.37 | ABS53c | 15 | MC-12b | MT-32 | 2.5~4 | 1 | 18 |
| 1.5 | 3.06 | ABS53c | 15 | MC-18b | MT-32 | 2.5~4 | 1 | 18 |
| 2.2 | 4.42 | ABS53c | 15 | MC-22b | MT-32 | 4~6 | 1 | 18 |
| 3.0 | 5.77 | ABS53c | 15 | MC-22b | MT-32 | 5~8 | 1 | 18 |
| 4.0 | 7.90 | ABS53c | 15 | MC-32a | MT-32 | 6~9 | 1 | 18 |
| 5.5 | 10.40 | ABS53c | 15 | MC-32a | MT-32 | 9~13 | 3 | 18 |
| 7.5 | 13.70 | ABS53c | 20 | MC-32a | MT-32 | 12~18 | 3 | 18 |
| 11.0 | 20.10 | ABS103c | 30 | MC-40a | MT-32 | 18~25 | 3 | 37 |
| 15.0 | 26.50 | ABS103c | 40 | MC-40a | MT-32 | 22~32 | 3 | 37 |
| 18.5 | 32.80 | ABS103c | 40 | MC-50a | MT-63 | 28~40 | 3 | 37 |
| 22.0 | 39.00 | ABS103c | 50 | MC-50a | MT-63 | 34~50 | 3 | 37 |
| 30.0 | 51.50 | ABS103c | 75 | MC-65a | MT-63 | 45~65 | 3 | 37 |
| 37.0 | 64.00 | ABS103c | 75 | MC-75a | MT-95 | 54~75 | 5 | 37 |
| 45.0 | 76.00 | ABS103c | 100 | MC-85a | MT-95 | 63~85 | 5 | 37 |
| 55.0 | 90.00 | ABS103c | 100 | MC-100a | MT-95 | 70~95 | 5 | 37 |
| 59.0 | 97.00 | ABS103c | 100 | MC-130a | MT-150 | 80~105 | 5 | 37 |
| 75.0 | 125 | ABS203c | 150 | MC-150a | MT-150 | 110~150 | 10 | 37 |
| 90.0 | 146 | ABS203c | 200 | MC-185a | MT-225 | 120~185 | 10 | 37 |
| 110.0 | 178 | ABS203c | 200 | MC-185a | MT-225 | 160~240 | 10 | 37 |
| 132.0 | 215 | ABS203c | 250 | MC-225a | MT-225 | 160~240 | 10 | 37 |
| 160.0 | 256 | ABS403c | 300 | MC-400a | MT-400 | 200~330 | 18 | 50 |
| 200.0 | 330 | ABS403c | 400 | MC-400a | MT-400 | 260~400 | 18 | 50 |
| 220.0 | 353 | ABS403c | 400 | MC-400a | MT-400 | 260~400 | 18 | 50 |
| 250.0 | 401 | ABS803c | 500 | MC-630a | MT-800 | 260~400 | 18 | 65 |
| 300.0 | 481 | ABS803c | 500 | MC-630a | MT-800 | 400~630 | 18 | 65 |

440V

Metasol MCCB H-type

| Rated operational power | | Circuit breaker | | Contactor | Thermal overload relays | | Short circuit breaking capacity | |
|-------------------------|-------------|-----------------|------------|-----------|-------------------------|-------------------|---------------------------------|---------------------|
| kW | Current [A] | Type | Rating [A] | Type | Type | Setting range [A] | I _r [kA] | I _q [kA] |
| | 440V | | | | | | | |
| 1.1 | 2.37 | ABH53c | 15 | MC-12b | MT-32 | 2.5~4 | 1 | 35 |
| 1.5 | 3.06 | ABH53c | 15 | MC-18b | MT-32 | 2.5~4 | 1 | 35 |
| 2.2 | 4.42 | ABH53c | 15 | MC-22b | MT-32 | 4~6 | 1 | 35 |
| 3 | 5.77 | ABH53c | 15 | MC-22b | MT-32 | 5~8 | 1 | 35 |
| 4 | 7.90 | ABH53c | 15 | MC-32a | MT-32 | 6~9 | 1 | 35 |
| 5.5 | 10.40 | ABH53c | 15 | MC-32a | MT-32 | 9~13 | 3 | 35 |
| 7.5 | 13.70 | ABH53c | 20 | MC-32a | MT-32 | 12~18 | 3 | 35 |
| 11 | 20.10 | ABH103c | 30 | MC-40a | MT-32 | 18~25 | 3 | 50 |
| 15 | 26.50 | ABH103c | 40 | MC-40a | MT-32 | 22~32 | 3 | 50 |
| 18.5 | 32.80 | ABH103c | 40 | MC-50a | MT-63 | 28~40 | 3 | 50 |
| 22 | 39.00 | ABH103c | 50 | MC-50a | MT-63 | 34~50 | 3 | 50 |
| 30 | 51.50 | ABH103c | 75 | MC-65a | MT-63 | 45~65 | 3 | 50 |
| 37 | 64.00 | ABH103c | 75 | MC-75a | MT-95 | 54~75 | 5 | 50 |
| 45 | 76.00 | ABH103c | 100 | MC-85a | MT-95 | 63~85 | 5 | 50 |
| 55 | 90.00 | ABH103c | 100 | MC-100a | MT-95 | 70~95 | 5 | 50 |
| 59 | 97.00 | ABH103c | 100 | MC-130a | MT-150 | 80~105 | 5 | 50 |
| 75 | 125 | ABH203c | 150 | MC-150a | MT-150 | 110~150 | 10 | 50 |
| 90 | 146 | ABH203c | 200 | MC-185a | MT-225 | 120~185 | 10 | 50 |
| 110 | 178 | ABH203c | 200 | MC-185a | MT-225 | 160~240 | 10 | 50 |
| 132 | 215 | ABH203c | 250 | MC-225a | MT-225 | 160~240 | 10 | 50 |
| 160 | 256 | ABL403c | 300 | MC-400a | MT-400 | 200~330 | 18 | 85 |
| 200 | 330 | ABL403c | 400 | MC-400a | MT-400 | 260~400 | 18 | 85 |
| 220 | 353 | ABL403c | 400 | MC-400a | MT-400 | 260~400 | 18 | 85 |
| 250 | 401 | ABL803c | 500 | MC-630a | MT-800 | 260~400 | 18 | 85 |
| 300 | 481 | ABL803c | 500 | MC-630a | MT-800 | 400~630 | 18 | 85 |

Type 2 coordination (MCi series)

| Circuit breaker (ACB) | | | Contactor(MCi) | | Short circuit |
|-----------------------|-------------|-----------|----------------|-----------|-------------------------------------|
| ACB type | CRADLE type | Rating(A) | Type | Rating(A) | I _r =I _q (kA) |
| AN-16C3-16A | AL-H16C3 | 1600 | MCi-900 | 900 | 42 |
| AN-16C3-16A | AL-H16C3 | 1600 | MCi-1050 | 1050 | 42 |
| AN-16C3-16A | AL-H16C3 | 1600 | MCi-1260 | 1260 | 42 |
| AH-32E3-32A | AL-H06~32E3 | 3200 | MCi-1700 | 1700 | 42 |
| AH-32E3-32A | AL-H06~32E3 | 3200 | MCi-2100 | 2100 | 42 |
| AH-32E3-32A | AL-H06~32E3 | 3200 | MCi-2650 | 2650 | 42 |

* Breaker (ACB) Model AN-16C3-16A when the OCR Override setting is "On"

Rated UL 508 combination motor controller type-C

Metasol MS

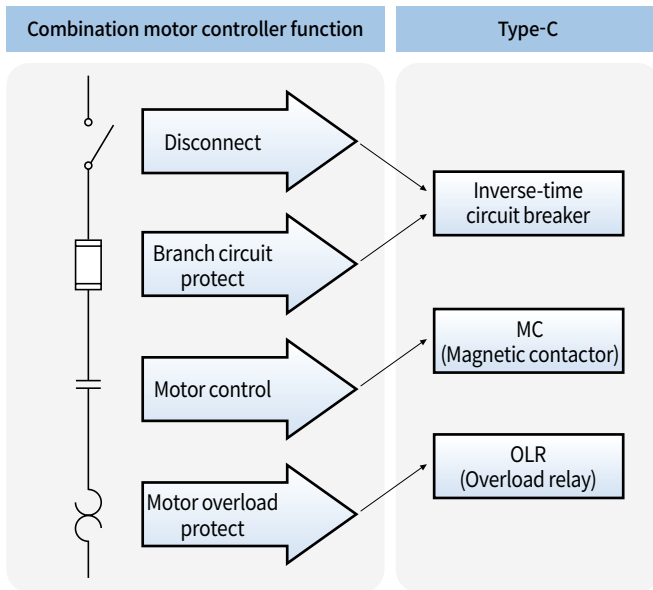

240V

Susol UL MCCB C-type

| CB | MC | OLR | kA@240V | Maximum HP | Maximum NEC FLC [A] |
|---------|--------|---------------|---------|------------|---------------------|
| UTE100E | MC-6a | MT-12 0.1~10A | 50 | 3 | 9.6 |
| UTE100N | | | 65 | 3 | |
| UTE100E | MC-9a | MT-12 0.1~10A | 50 | 3 | 9.6 |
| UTE100N | | | 65 | 3 | |
| UTE100E | MC-12a | MT-12 0.1~18A | 50 | 5 | 15.2 |
| UTE100N | | | 65 | 5 | |
| UTE100E | MC-18a | MT-12 0.1~18A | 50 | 7.5 | 22 |
| UTE100N | | | 65 | 7.5 | |
| UTS150N | | | 65 | 7.5 | |
| UTS150L | | | 100 | 7.5 | |
| UTE100E | | | 50 | 7.5 | |
| UTE100E | MC-9b | MT-32 0.1~10A | 50 | 3 | 9.6 |
| UTE100N | | | 65 | 3 | |
| UTE100E | MC-12b | MT-32 0.1~18A | 50 | 5 | 15.2 |
| UTE100N | | | 65 | 5 | |
| UTE100E | MC-18b | MT-32 0.1~25A | 50 | 7.5 | 22 |
| UTE100N | | | 65 | 7.5 | |
| UTS150N | | | 65 | 7.5 | |
| UTS150L | | | 100 | 7.5 | |

| CB | MC | OLR | kA@240V | Maximum HP | Maximum NEC FLC [A] |
|---------|--------|---------------|---------|------------|---------------------|
| UTE100E | MC-22b | MT-32 0.1~32A | 50 | 10 | 28 |
| UTE100N | | | 65 | 10 | |
| UTS150N | | | 65 | 10 | |
| UTS150L | | | 100 | 10 | |
| UTE100E | MC-32a | MT-32 0.1~32A | 50 | 10 | 28 |
| UTE100N | | | 65 | 10 | |
| UTS150N | | | 65 | 10 | |
| UTS150L | | | 100 | 10 | |
| UTE100E | MC-40a | MT-32 0.1~40A | 50 | 15 | 42 |
| UTE100N | | | 65 | 15 | |
| UTS150N | | | 65 | 15 | |
| UTS150L | | | 100 | 15 | |

Rated UL 508 combination motor controller type-C

240V

Susol UL MCCB C-type

| CB | MC | OLR | kA@240V | Maximum HP | Maximum NEC FLC [A] | CB | MC | OLR | kA@240V | Maximum HP | Maximum NEC FLC [A] |
|---------|--------|------------------|---------|------------|---------------------|---------|---------|--------------------|---------|--------------------|---------------------|
| UTE100E | MC-6a | MT-12 0.1~10A | 50 | 3 | 9.6 | UTE100E | MC-65a | MT-63 4~65A | 50 | 30 | 80 |
| UTE100N | | | 65 | 3 | | UTE100N | | | 65 | 30 | |
| UTE100E | MC-9a | MT-12 0.1~10A | 50 | 3 | 9.6 | UTS150N | | | 65 | 30 | |
| UTE100N | | | 65 | 3 | | UTS150L | | | 100 | 30 | |
| UTE100E | MC-12a | MT-12 0.1~18A | 50 | 5 | 15.2 | UTS150N | MC-75a | MT-95 7~95A | 65 | 30 | 80 |
| UTE100N | | | 65 | 5 | | UTS150L | | | 100 | 30 | |
| UTE100E | MC-18a | MT-12 0.1~18A | 50 | 7.5 | 22 | UTS150N | MC-85a | MT-95 7~100A | 65 | 40 | 104 |
| UTE100N | | | 65 | 7.5 | | UTS150L | | | 100 | 40 | |
| UTS150N | | | 65 | 7.5 | | UTS150N | MC-100a | MT-95 7~100A | 65 | 40 | 104 |
| UTS150L | | | 100 | 7.5 | | UTS150L | | | 100 | 40 | |
| UTE100E | MC-9b | MT-32 0.1~10A | 50 | 3 | 9.6 | UTS150N | MC-130a | MT-150 34~130A | 65 | 40 | 104 |
| UTE100N | | | 65 | 3 | | UTS150L | | | 100 | 40 | |
| UTE100E | MC-12b | MT-32 0.1~18A | 50 | 5 | 15.2 | UTS150N | MC-150a | MT-150 34~130A | 65 | 50 | 130 |
| UTE100N | | | 65 | 5 | | UTS150L | | | 100 | 50 | |
| UTE100E | MC-18b | MT-32 0.1~25A | 50 | 7.5 | 22 | UTS250N | | | 65 | 50 | |
| UTE100N | | | 65 | 7.5 | | UTS250L | | | 100 | 50 | |
| UTS150N | | | 65 | 7.5 | | UTS250N | MC-185a | MT-225 65~185A | 65 | 60 | 154 |
| UTS150L | | | 100 | 7.5 | | UTS250L | | | 100 | 60 | |
| UTE100E | MC-22b | MT-32 0.1~32A | 50 | 10 | 28 | UTS400N | MC-225a | MT-225 65~240A | 65 | 60 | 192 |
| UTE100N | | | 65 | 10 | | UTS400L | | | 100 | 75 | |
| UTS150N | | | 65 | 10 | | UTS250N | 65 | | 75 | | |
| UTS150L | | | 100 | 10 | | UTS250L | 100 | | 75 | | |
| UTE100E | MC-32a | MT-32 0.1~32A | 50 | 10 | 28 | UTS400N | MC-265a | MT-400 85~330A | 65 | 100 | 248 |
| UTE100N | | | 65 | 10 | | UTS400L | | | 100 | 100 | |
| UTS150N | | | 65 | 10 | | UTS400N | MC-330a | MT-400 85~330A | 65 | 100 | 248 |
| UTS150L | | | 100 | 10 | | UTS400L | | | 100 | 100 | |
| UTE100E | MC-40a | MT-32 0.1~40A | 50 | 15 | 42 | UTS600N | MC-400a | MT-400 85~400A | 65 | 150 | 360 |
| UTE100N | | | 65 | 15 | | UTS600L | | | 100 | 150 | |
| UTS150N | | | 65 | 15 | | UTS800L | MC-500a | MT-800 200~600A | 100 | 200 | 480 |
| UTS150L | | | 100 | 15 | | UTS800L | | | MC-630a | MT-800 200~800A | |
| UTE100E | MC-50a | MT-63 4~65A | 50 | 25 | 65 | | | | | | |
| UTE100N | | | 65 | 25 | | | | | | | |
| UTS150N | | | 65 | 25 | | | | | | | |
| UTS150L | | | 100 | 25 | | | | | | | |

480V

Susol UL MCCB C-type

| CB | MC | OLR | Voltage (V) | Short circuit rating (kA) (4) | Maximum HP | Maximum NEC FLC [A] |
|---------|--------|------------------|-------------|-------------------------------|------------|---------------------|
| UTE100E | MC-6a | MT-12 0.1~10A | 480 | 25 | 5 | 7.6 |
| UTE100N | | | 480 | 35 | 5 | |
| UTE100E | MC-9a | MT-12 0.1~10A | 480 | 25 | 5 | 7.6 |
| UTE100N | | | 480 | 35 | 5 | |
| UTE100E | MC-12a | MT-12 0.1~13A | 480 | 25 | 7.5 | 11 |
| UTE100N | | | 480 | 35 | 7.5 | |
| UTE100E | MC-18a | MT-12 0.1~18A | 480 | 25 | 10 | 14 |
| UTE100N | | | 480 | 35 | 10 | |
| UTS150N | | | 480 | 35 | 10 | |
| UTS150H | | | 480 | 65 | 10 | |
| UTS150L | | | 480 | 100 | 10 | |
| UTE100E | MC-9b | MT-32 0.1~10A | 480 | 25 | 5 | 7.6 |
| UTE100N | | | 480 | 35 | 5 | |
| UTE100E | MC-12b | MT-32 0.1~13A | 480 | 25 | 7.5 | 11 |
| UTE100N | | | 480 | 35 | 7.5 | |
| UTE100E | MC-18b | MT-32 0.1~18A | 480 | 25 | 10 | 14 |
| UTE100N | | | 480 | 35 | 10 | |
| UTE100E | MC-22b | MT-32 0.1~25A | 480 | 25 | 15 | 21 |
| UTE100N | | | 480 | 35 | 15 | |
| UTS150N | | | 480 | 35 | 15 | |
| UTS150H | | | 480 | 65 | 15 | |
| UTS150L | | | 480 | 100 | 15 | |
| UTE100E | MC-32a | MT-32 0.1~32A | 480 | 25 | 20 | 27 |
| UTE100N | | | 480 | 35 | 20 | |
| UTS150N | | | 480 | 35 | 20 | |
| UTS150H | | | 480 | 65 | 20 | |
| UTE100E | MC-40a | MT-32 0.1~40A | 480 | 25 | 30 | 40 |
| UTE100N | | | 480 | 35 | 30 | |
| UTS150N | | | 480 | 35 | 30 | |
| UTS150H | | | 480 | 65 | 30 | |
| UTS150L | | | 480 | 100 | 30 | |
| UTE100E | MC-50a | MT-63 4~65A | 480 | 25 | 40 | 52 |
| UTE100N | | | 480 | 35 | 40 | |
| UTS150N | | | 480 | 35 | 40 | |
| UTS150H | | | 480 | 65 | 40 | |
| UTS150L | | | 480 | 100 | 40 | |
| UTE100E | MC-65a | MT-63 4~65A | 480 | 25 | 50 | 65 |
| UTE100N | | | 480 | 35 | 50 | |
| UTS150N | | | 480 | 35 | 50 | |
| UTS150H | | | 480 | 65 | 50 | |
| UTS150L | | | 480 | 100 | 50 | |

| CB | MC | OLR | Voltage (V) | Short circuit rating (kA) (4) | Maximum HP | Maximum NEC FLC [A] |
|---------|---------|--------------------|-------------|-------------------------------|------------|---------------------|
| UTS150N | MC-75a | MT-95 7~75A | 480 | 35 | 50 | 65 |
| UTS150H | | | 480 | 65 | 50 | |
| UTS150L | | | 480 | 100 | 50 | |
| UTS150N | MC-85a | MT-95 7~85A | 480 | 35 | 60 | 77 |
| UTS150H | | | 480 | 65 | 60 | |
| UTS150L | | | 480 | 100 | 60 | |
| UTS150N | MC-100a | MT-95 7~100A | 480 | 35 | 75 | 96 |
| UTS150H | | | 480 | 65 | 75 | |
| UTS150L | | | 480 | 100 | 75 | |
| UTS150N | MC-130a | MT-150 34~130A | 480 | 35 | 75 | 96 |
| UTS150H | | | 480 | 65 | 75 | |
| UTS150L | | | 480 | 100 | 75 | |
| UTS150N | MC-150a | MT-150 34~130A | 480 | 35 | 100 | 124 |
| UTS150H | | | 480 | 65 | 100 | |
| UTS150L | | | 480 | 100 | 100 | |
| UTS250N | | | 480 | 35 | 100 | |
| UTS250H | | | 480 | 65 | 100 | |
| UTS250L | | | 480 | 100 | 100 | |
| UTS250N | MC-185a | MT-225 65~185A | 480 | 35 | 125 | 156 |
| UTS250H | | | 480 | 65 | 125 | |
| UTS250L | | | 480 | 100 | 125 | |
| UTS400N | | | 480 | 35 | 150 | |
| UTS400H | | | 480 | 65 | 150 | |
| UTS400L | 480 | 100 | 150 | | | |
| UTS250N | MC-225a | MT-225 65~240A | 480 | 35 | 125 | 180 |
| UTS250H | | | 480 | 65 | 125 | |
| UTS250L | | | 480 | 100 | 125 | |
| UTS400N | | | 480 | 35 | 150 | |
| UTS400H | MC-265a | MT-400 85~330A | 480 | 65 | 200 | 240 |
| UTS400L | | | 480 | 100 | 200 | |
| UTS400N | MC-330a | MT-400 85~330A | 480 | 35 | 200 | 302 |
| UTS400H | | | 480 | 65 | 200 | |
| UTS400L | | | 480 | 100 | 200 | |
| UTS600N | MC-400a | MT-400 85~400A | 480 | 35 | 300 | 361 |
| UTS600H | | | 480 | 65 | 300 | |
| UTS600L | | | 480 | 100 | 300 | |
| UTS800H | MC-500a | MT-800 200~600A | 480 | 65 | 400 | 477 |
| UTS800L | | | 480 | 100 | 400 | |
| UTS800H | MC-630a | MT-800 200~800A | 480 | 65 | 500 | 590 |
| UTS800L | MC-630a | | 480 | 100 | 500 | |

Rated UL 508 combination motor controller type-C

600V

Susol UL MCCB C-type

| CB | MC | OLR | Voltage (V) | Maximum HP | Maximum HP | Maximum NEC FLC [A] |
|---------|--------|------------------|-------------|------------|------------|---------------------|
| UTE100E | MC-6a | MT-12 0.1~10A | 600Y/347 | 14 | 7.5 | 9 |
| UTE100N | | | 600Y/347 | 18 | 7.5 | |
| UTE100E | MC-9a | MT-12 0.1~10A | 600Y/347 | 14 | 7.5 | 9 |
| UTE100N | | | 600Y/347 | 18 | 7.5 | |
| UTE100E | MC-12a | MT-12 0.1~13A | 600Y/347 | 14 | 10 | 11 |
| UTE100N | | | 600Y/347 | 18 | 10 | |
| UTE100E | MC-18a | MT-12 0.1~18A | 600Y/347 | 14 | 15 | 17 |
| UTE100N | | | 600Y/347 | 18 | 15 | |
| UTS150N | | | 600 | 18 | 15 | |
| UTS150H | | | 600 | 35 | 15 | |
| UTS150L | | | 600 | 50 | 15 | |
| UTS150L | | | 600 | 50 | 15 | |
| UTE100E | MC-9b | MT-32 0.1~10A | 600Y/347 | 14 | 7.5 | 9 |
| UTE100N | | | 600Y/347 | 18 | 7.5 | |
| UTE100E | MC-12b | MT-32 0.1~13A | 600Y/347 | 14 | 10 | 11 |
| UTE100N | | | 600Y/347 | 18 | 10 | |
| UTE100E | MC-18b | MT-32 0.1~18A | 600Y/347 | 14 | 15 | 17 |
| UTE100N | | | 600Y/347 | 18 | 15 | |
| UTE100E | MC-22b | MT-32 0.1~25A | 600Y/347 | 14 | 20 | 22 |
| UTE100N | | | 600Y/347 | 18 | 20 | |
| UTS150N | | | 600 | 18 | 20 | |
| UTS150H | | | 600 | 35 | 20 | |
| UTS150L | | | 600 | 50 | 20 | |
| UTS150L | | | 600 | 50 | 20 | |
| UTE100E | MC-32a | MT-32 0.1~32A | 600Y/347 | 14 | 25 | 27 |
| UTE100N | | | 600Y/347 | 18 | 25 | |
| UTS150N | | | 600 | 18 | 25 | |
| UTS150H | | | 600 | 35 | 25 | |
| UTS150L | | | 600 | 50 | 25 | |
| UTE100E | MC-40a | MT-32 0.1~32A | 600Y/347 | 14 | 30 | 32 |
| UTE100N | | | 600Y/347 | 18 | 30 | |
| UTS150N | | | 600 | 18 | 30 | |
| UTS150H | | | 600 | 35 | 30 | |
| UTS150L | | | 600 | 50 | 30 | |
| UTE100E | MC-50a | MT-63 4~65A | 600Y/347 | 14 | 50 | 52 |
| UTE100N | | | 600Y/347 | 18 | 50 | |
| UTS150N | | | 600 | 18 | 50 | |
| UTS150H | | | 600 | 35 | 50 | |
| UTS150L | | | 600 | 50 | 50 | |
| UTE100E | MC-65a | MT-63 4~65A | 600Y/347 | 14 | 60 | 62 |
| UTE100N | | | 600Y/347 | 18 | 60 | |
| UTS150N | | | 600 | 18 | 60 | |
| UTS150H | | | 600 | 35 | 60 | |
| UTS150L | | | 600 | 50 | 60 | |

| CB | MC | OLR | Voltage (V) | Maximum HP | Maximum HP | Maximum NEC FLC [A] |
|---------|---------|--------------------|-------------|------------|------------|---------------------|
| UTS150N | MC-75a | MT-95 7~75A | 600 | 18 | 60 | 62 |
| UTS150H | | | 600 | 35 | 60 | |
| UTS150L | | | 600 | 50 | 60 | |
| UTS150N | MC-85a | MT-95 7~85A | 600 | 18 | 75 | 77 |
| UTS150H | | | 600 | 35 | 75 | |
| UTS150L | | | 600 | 50 | 75 | |
| UTS150N | MC-100a | MT-95 7~85A | 600 | 18 | 75 | 77 |
| UTS150H | | | 600 | 35 | 75 | |
| UTS150L | | | 600 | 50 | 75 | |
| UTS150N | MC-130a | MT-150 34~85A | 600 | 18 | 75 | 77 |
| UTS150H | | | 600 | 35 | 75 | |
| UTS150L | | | 600 | 50 | 75 | |
| UTS150N | MC-150a | MT-150 34~85A | 600 | 18 | 75 | 77 |
| UTS150H | | | 600 | 35 | 75 | |
| UTS150L | | | 600 | 50 | 75 | |
| UTS250N | MC-185a | MT-150 65~185A | 600 | 18 | 125 | 125 |
| UTS250H | | | 600 | 35 | 125 | |
| UTS250L | | | 600 | 50 | 125 | |
| UTS400N | | | 600 | 18 | 150 | |
| UTS400H | | | 600 | 35 | 150 | |
| UTS400L | | | 600 | 50 | 150 | |
| UTS250N | MC-225a | MT-225 65~185A | 600 | 18 | 125 | 144 |
| UTS250H | | | 600 | 35 | 125 | |
| UTS250L | | | 600 | 50 | 125 | |
| UTS400N | | | 600 | 18 | 150 | |
| UTS400H | | | 600 | 35 | 150 | |
| UTS400L | 600 | 50 | 150 | | | |
| UTS400N | MC-265a | MT-400 85~240A | 600 | 18 | 200 | 192 |
| UTS400H | | | 600 | 35 | 200 | |
| UTS400L | | | 600 | 50 | 200 | |
| UTS400N | MC-330a | MT-400 85~330A | 600 | 18 | 200 | 242 |
| UTS400H | | | 600 | 35 | 200 | |
| UTS400L | | | 600 | 50 | 200 | |
| UTS600N | MC-400a | MT-400 85~400A | 600 | 18 | 300 | 289 |
| UTS600H | | | 600 | 35 | 300 | |
| UTS600L | | | 600 | 50 | 300 | |
| UTS800H | MC-500a | MT-800 200~400A | 600 | 35 | 400 | 382 |
| UTS800L | | | 600 | 50 | 400 | |
| UTS800H | MC-630a | MT-800 200~600A | 600 | 35 | 500 | 472 |
| UTS800L | | | 600 | 50 | 500 | |

Rated UL 508 combination motor controller type-D Metasol MS

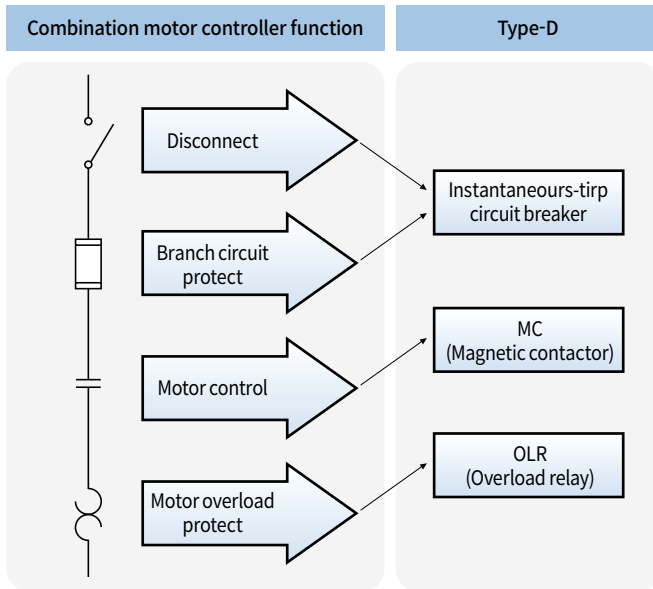

240V

Susol UL MCCB D-type

| CB | MC | OLR | kA@240V | Maximum HP | Maximum NEC FLC [A] |
|-------------|--------|------------------|---------|------------|---------------------|
| UTS150L MCP | MC-6a | MT-12 0.1~10A | 100 | 3 | 9.6 |
| UTS150L MCP | MC-9a | MT-12 0.1~10A | 100 | 3 | 9.6 |
| UTS150L MCP | MC-12a | MT-12 0.1~18A | 100 | 5 | 15.2 |
| UTS150L MCP | MC-18a | MT-12 0.1~18A | 100 | 7.5 | 22 |
| UTS150L MCP | MC-9b | MT-32 0.1~10A | 100 | 3 | 9.6 |
| UTS150L MCP | MC-12b | MT-32 0.1~18A | 100 | 5 | 15.2 |
| UTS150L MCP | MC-18b | MT-32 0.1~25A | 100 | 7.5 | 22 |
| UTS150L MCP | MC-22b | MT-32 0.1~32A | 100 | 10 | 28 |
| UTS150L MCP | MC-32a | MT-32 0.1~32A | 100 | 10 | 28 |
| UTS150L MCP | MC-40a | MT-32 0.1~40A | 100 | 15 | 42 |
| UTS150L MCP | MC-50a | MT-63 4~65A | 100 | 25 | 65 |
| UTS150L MCP | MC-65a | MT-63 4~65A | 100 | 30 | 80 |
| UTS150L MCP | MC-75a | MT-95 7~95A | 100 | 30 | 80 |

| CB | MC | OLR | kA@240V | Maximum HP | Maximum NEC FLC [A] |
|-------------|---------|--------------------|---------|------------|---------------------|
| UTS150L MCP | MC-85a | MT-95 7~100A | 100 | 40 | 104 |
| UTS150L MCP | MC-100a | MT-95 7~100A | 100 | 40 | 104 |
| UTS150L MCP | MC-130a | MT-150 34~130A | 100 | 40 | 104 |
| UTS250L MCP | MC-150a | MT-150 34~130A | 100 | 50 | 130 |
| UTS250L MCP | MC-185a | MT-225 65~160A | 100 | 60 | 154 |
| UTS400L MCP | MC-185a | MT-225 65~185A | 100 | 60 | 154 |
| UTS250L MCP | MC-225a | MT-225 65~240A | 100 | 75 | 192 |
| UTS400L MCP | MC-225a | MT-225 65~240A | 100 | 75 | 192 |
| UTS400L MCP | MC-265a | MT-400 85~330A | 100 | 100 | 248 |
| UTS400L MCP | MC-330a | MT-400 85~330A | 100 | 100 | 248 |
| UTS600L MCP | MC-400a | MT-400 85~400A | 100 | 150 | 360 |
| UTS800L MCP | MC-500a | MT-800 200~600A | 100 | 200 | 480 |
| UTS800L MCP | MC-630a | MT-800 200~800A | 100 | 250 | 604 |

Rated UL 508 combination motor controller type-D

480V

Susol UL MCCB D-type

| CB | MC | OLR | kA@400V | Maximum HP | Maximum NEC FLC [A] |
|-------------|---------|------------------|---------|------------|---------------------|
| UTS150L MCP | MC-6a | MT-12 0.1~10A | 65 | 5 | 7.6 |
| UTS150L MCP | MC-9a | MT-12 0.1~10A | 65 | 5 | 7.6 |
| UTS150L MCP | MC-12a | MT-12 0.1~13A | 65 | 7.5 | 11 |
| UTS150L MCP | MC-18a | MT-12 0.1~18A | 65 | 10 | 14 |
| UTS150L MCP | MC-9b | MT-32 0.1~10A | 65 | 5 | 7.6 |
| UTS150L MCP | MC-12b | MT-32 0.1~13A | 65 | 7.5 | 11 |
| UTS150L MCP | MC-18b | MT-32 0.1~18A | 65 | 10 | 14 |
| UTS150L MCP | MC-22b | MT-32 0.1~25A | 65 | 15 | 21 |
| UTS150L MCP | MC-32a | MT-32 0.1~32A | 65 | 20 | 27 |
| UTS150L MCP | MC-40a | MT-32 0.1~40A | 65 | 20 | 40 |
| UTS150H MCP | MC-50a | MT-63 4~65A | 65 | 40 | 52 |
| UTS150L MCP | MC-50a | MT-63 4~65A | 100 | 40 | 52 |
| UTS150H MCP | MC-65a | MT-63 4~65A | 65 | 50 | 65 |
| UTS150L MCP | MC-65a | MT-63 4~65A | 100 | 50 | 65 |
| UTS150H MCP | MC-75a | MT-95 7~75A | 65 | 50 | 65 |
| UTS150L MCP | MC-75a | MT-95 7~75A | 100 | 50 | 65 |
| UTS150H MCP | MC-85a | MT-95 7~85A | 65 | 60 | 77 |
| UTS150L MCP | MC-85a | MT-95 7~85A | 100 | 60 | 77 |
| UTS150H MCP | MC-100a | MT-95 7~100A | 65 | 75 | 96 |
| UTS150L MCP | MC-100a | MT-95 7~100A | 100 | 75 | 96 |

| CB | MC | OLR | kA@400V | Maximum HP | Maximum NEC FLC [A] |
|-------------|---------|--------------------|---------|------------|---------------------|
| UTS150H MCP | MC-130a | MT-150 34~130A | 65 | 75 | 96 |
| UTS150L MCP | MC-130a | MT-150 34~130A | 100 | 75 | 96 |
| UTS250H MCP | MC-150a | MT-150 34~130A | 65 | 100 | 124 |
| UTS250L MCP | MC-150a | MT-150 34~130A | 100 | 100 | 124 |
| UTS250H MCP | MC-185a | MT-225 65~185A | 65 | 125 | 156 |
| UTS250L MCP | MC-185a | MT-225 65~185A | 85 | 125 | 156 |
| UTS400H MCP | MC-185a | MT-225 65~185A | 65 | 125 | 156 |
| UTS400L MCP | MC-185a | MT-225 65~185A | 100 | 125 | 156 |
| UTS250H MCP | MC-225a | MT-225 65~240A | 65 | 150 | 180 |
| UTS250L MCP | MC-225a | MT-225 65~240A | 85 | 150 | 180 |
| UTS400H MCP | MC-225a | MT-225 65~240A | 65 | 150 | 180 |
| UTS400L MCP | MC-225a | MT-225 65~240A | 100 | 150 | 180 |
| UTS400H MCP | MC-265a | MT-400 85~330A | 65 | 200 | 240 |
| UTS400L MCP | MC-265a | MT-400 85~330A | 100 | 200 | 240 |
| UTS400H MCP | MC-330a | MT-400 85~330A | 65 | 200 | 240 |
| UTS400L MCP | MC-330a | MT-400 85~330A | 100 | 200 | 240 |
| UTS600H MCP | MC-400a | MT-400 85~400A | 65 | 300 | 361 |
| UTS600L MCP | MC-400a | MT-400 85~400A | 100 | 300 | 361 |
| UTS800L MCP | MC-500a | MT-800 200~600A | 100 | 400 | 477 |
| UTS800L MCP | MC-630a | MT-800 200~800A | 100 | 500 | 590 |

600V

Susol UL MCCB D-type

| CB | MC | OLR | kA@600V | Maximum HP | Maximum NEC FLC [A] | CB | MC | OLR | kA@600V | Maximum HP | Maximum NEC FLC [A] |
|-------------|---------|------------------|---------|------------|---------------------|-------------|---------|--------------------|---------|------------|---------------------|
| UTS150L MCP | MC-6a | MT-12 0.1~10A | 25 | 7.5 | 9 | UTS150H MCP | MC-130a | MT-150 65~185A | 25 | 75 | 77 |
| UTS150L MCP | MC-9a | MT-12 0.1~10A | 25 | 7.5 | 9 | UTS150L MCP | MC-130a | MT-150 65~185A | 50 | 75 | 77 |
| UTS150L MCP | MC-12a | MT-12 0.1~13A | 25 | 10 | 11 | UTS150H MCP | MC-150a | MT-150 65~185A | 25 | 75 | 77 |
| UTS150L MCP | MC-18a | MT-12 0.1~18A | 25 | 15 | 17 | UTS150L MCP | MC-150a | MT-150 65~185A | 50 | 75 | 77 |
| UTS150L MCP | MC-9b | MT-32 0.1~10A | 25 | 7.5 | 9 | UTS250H MCP | MC-185a | MT-225 65~185A | 25 | 125 | 125 |
| UTS150L MCP | MC-12b | MT-32 0.1~13A | 25 | 10 | 11 | UTS250L MCP | MC-185a | MT-225 65~185A | 50 | 125 | 125 |
| UTS150L MCP | MC-18b | MT-32 0.1~18A | 25 | 15 | 17 | UTS400H MCP | MC-185a | MT-225 65~185A | 25 | 125 | 125 |
| UTS150L MCP | MC-22b | MT-32 0.1~25A | 25 | 20 | 22 | UTS400L MCP | MC-185a | MT-225 65~185A | 50 | 125 | 125 |
| UTS150L MCP | MC-32a | MT-32 0.1~32A | 25 | 25 | 27 | UTS250H MCP | MC-225a | MT-225 65~185A | 25 | 150 | 144 |
| UTS150L MCP | MC-40a | MT-32 0.1~32A | 25 | 25 | 32 | UTS250L MCP | MC-225a | MT-225 65~185A | 50 | 150 | 144 |
| UTS150H MCP | MC-50a | MT-63 4~65A | 25 | 50 | 52 | UTS400H MCP | MC-225a | MT-225 65~185A | 25 | 150 | 144 |
| UTS150L MCP | MC-50a | MT-63 4~65A | 50 | 50 | 62 | UTS400L MCP | MC-225a | MT-225 65~185A | 50 | 150 | 144 |
| UTS150H MCP | MC-65a | MT-63 4~65A | 25 | 60 | 62 | UTS400H MCP | MC-265a | MT-400 85~240A | 25 | 200 | 192 |
| UTS150L MCP | MC-65a | MT-63 4~65A | 50 | 60 | 62 | UTS400L MCP | MC-265a | MT-400 85~240A | 50 | 200 | 192 |
| UTS150H MCP | MC-75a | MT-95 7~75A | 25 | 60 | 77 | UTS400H MCP | MC-330a | MT-400 85~330A | 25 | 200 | 242 |
| UTS150L MCP | MC-75a | MT-95 7~75A | 50 | 60 | 77 | UTS400L MCP | MC-330a | MT-400 85~330A | 50 | 200 | 242 |
| UTS150H MCP | MC-85a | MT-95 7~85A | 25 | 75 | 77 | UTS600H MCP | MC-400a | MT-400 85~400A | 25 | 300 | 289 |
| UTS150L MCP | MC-85a | MT-95 7~85A | 50 | 75 | 77 | UTS600L MCP | MC-400a | MT-400 85~400A | 50 | 300 | 289 |
| UTS150H MCP | MC-100a | MT-95 7~85A | 25 | 75 | 77 | UTS800L MCP | MC-500a | MT-800 200~400A | 50 | 400 | 382 |
| UTS150L MCP | MC-100a | MT-95 7~85A | 50 | 75 | 77 | UTS800L MCP | MC-630a | MT-800 200~600A | 50 | 500 | 472 |

Rated UL 508 combination motor controller type-F

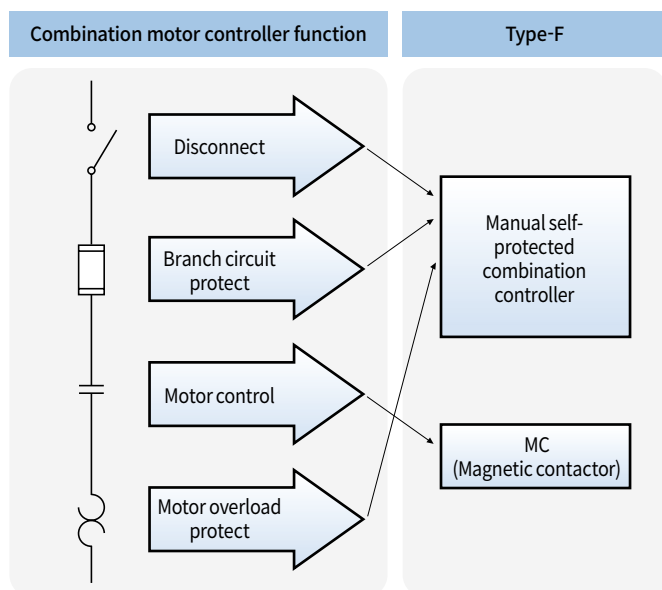

32AF rotary operation, High interruption

| Manual self-Protected | Adjustment range (A) | Short circuit rating (kA) | | | MC (Applied contactor) | |
|-----------------------|----------------------|---------------------------|-----------|-----------|------------------------|-------------------|
| | | 240V | 480Y/277V | 600Y/347V | Susol | Metasol |
| MMS-32H-0.16 | 0.1~0.16 | 100 | 65 | 25 | MC-9 | MC-6a/MC-9a/MC-9b |
| MMS-32H-0.25 | 0.16~0.25 | 100 | 65 | 25 | MC-9 | MC-6a/MC-9a/MC-9b |
| MMS-32H-0.4 | 0.25~0.4 | 100 | 65 | 25 | MC-9 | MC-6a/MC-9a/MC-9b |
| MMS-32H-0.63 | 0.4~0.63 | 100 | 65 | 25 | MC-9 | MC-6a/MC-9a/MC-9b |
| MMS-32H-1 | 0.63~1 | 100 | 65 | 25 | MC-9 | MC-6a/MC-9a/MC-9b |
| MMS-32H-1.6 | 1~1.6 | 100 | 65 | 25 | MC-9 | MC-6a/MC-9a/MC-9b |
| MMS-32H-2.5 | 1.6~2.5 | 100 | 65 | 25 | MC-12 | MC-12a/MC-12b |
| MMS-32H-4 | 2.5~4 | 100 | 65 | 25 | MC-12 | MC-12a/MC-12b |
| MMS-32H-6 | 4~6 | 100 | 65 | 25 | MC-18 | MC-18a/MC-18b |
| MMS-32H-8 | 5~8 | 100 | 65 | 10 | MC-18 | MC-18a/MC-18b |
| MMS-32H-10 | 6~10 | 100 | 65 | 10 | MC-18 | MC-18a/MC-18b |
| MMS-32H-13 | 9~13 | 100 | 65 | 10 | MC-25 | MC-22b/MC-25a |
| MMS-32H-17 | 11~17 | 100 | 30 | 10 | MC-25 | MC-22b/MC-25a |
| MMS-32H-22 | 14~22 | 100 | 30 | 10 | MC-25 | MC-22b/MC-25a |
| MMS-32H-26 | 18~26 | 100 | 30 | 10 | MC-32 | MC-32a |
| MMS-32H-32 | 22~32 | 100 | 30 | 10 | MC-32 | MC-32a |
| MMS-32H-40 | 28~40 | 100 | 30 | 10 | - | MC-35a/MC-40a |

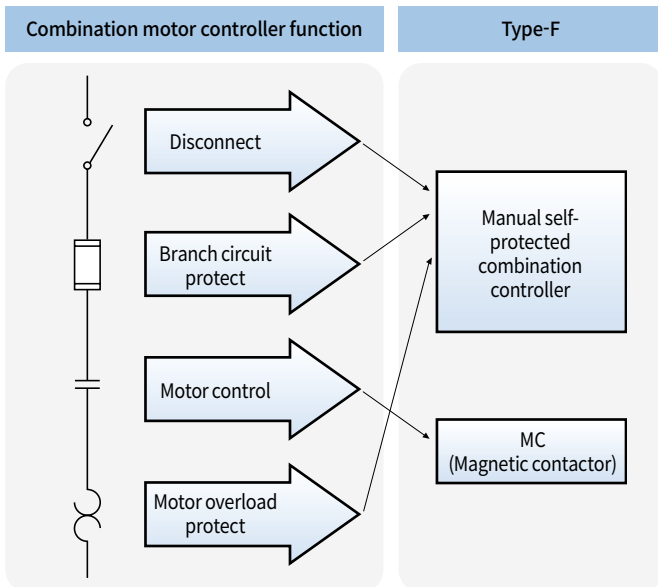

63AF rotary operation, Standard interruption

| Manual self-Protected | Adjustment range (A) | Short circuit rating (kA) | | | MC (Applied contactor) | |
|-----------------------|----------------------|---------------------------|-----------|-----------|------------------------|---------|
| | | 240V | 480Y/277V | 600Y/347V | Susol | Metasol |
| MMS-63S-10 | 6~10 | 100 | 50 | 10 | MC-35 | MC-50a |
| MMS-63S-13 | 9~13 | 100 | 50 | 10 | MC-35 | MC-50a |
| MMS-63S-17 | 11~17 | 100 | 40 | 10 | MC-35 | MC-50a |
| MMS-63S-22 | 14~22 | 100 | 40 | 10 | MC-35 | MC-50a |
| MMS-63S-26 | 18~26 | 100 | 40 | 10 | MC-35 | MC-50a |
| MMS-63S-32 | 22~32 | 100 | 40 | 10 | MC-35 | MC-50a |
| MMS-63S-40 | 28~40 | 100 | 40 | 10 | MC-40 | MC-50a |
| MMS-63S-50 | 34~50 | 100 | 40 | 10 | MC-50 | MC-50a |
| MMS-63S-63 | 45~63 | 100 | 40 | 10 | MC-63 | MC-65a |
| MMS-63S-65 | 47~65 | 100 | 40 | 10 | - | MC-65a |

63AF rotary operation, High interruption

| Manual self-Protected | Adjustment range (A) | Short circuit rating (kA) | | | MC (Applied contactor) | |
|-----------------------|----------------------|---------------------------|-----------|-----------|------------------------|---------|
| | | 240V | 480Y/277V | 600Y/347V | Susol | Metasol |
| MMS-63H-10 | 6~10 | 100 | 65 | 25 | MC-35 | MC-50a |
| MMS-63H-13 | 9~13 | 100 | 65 | 25 | MC-35 | MC-50a |
| MMS-63H-17 | 11~17 | 100 | 50 | 10 | MC-35 | MC-50a |
| MMS-63H-22 | 14~22 | 100 | 50 | 10 | MC-35 | MC-50a |
| MMS-63H-26 | 18~26 | 100 | 50 | 10 | MC-35 | MC-50a |
| MMS-63H-32 | 22~32 | 100 | 50 | 10 | MC-35 | MC-50a |
| MMS-63H-40 | 28~40 | 100 | 50 | 10 | MC-40 | MC-50a |
| MMS-63H-50 | 34~50 | 100 | 50 | 10 | MC-50 | MC-50a |
| MMS-63H-63 | 45~63 | 100 | 50 | 10 | MC-63 | MC-65a |
| MMS-63H-65 | 47~65 | 100 | 40 | 10 | - | MC-65a |

Rated UL 508 combination motor controller type-F

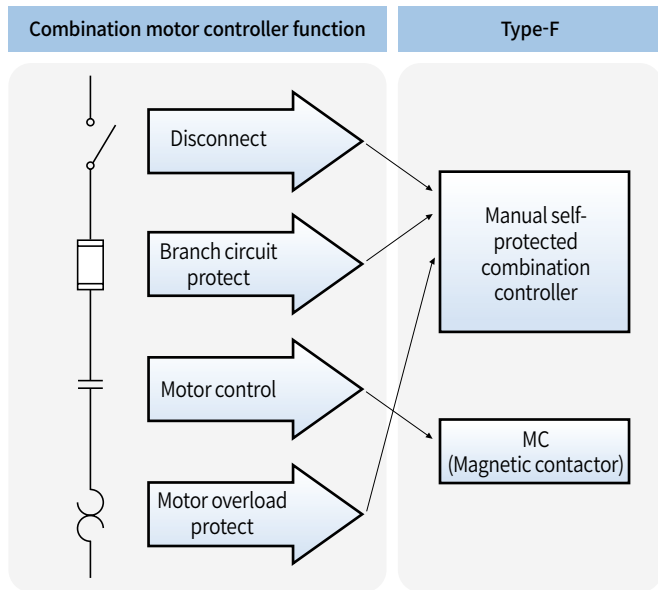

100AF rotary operation, Standard interruption

| Manual self-Protected | Adjustment range (A) | Short circuit rating (kA) | | | MC (Applied contactor) | |
|-----------------------|----------------------|---------------------------|-----------|-----------|------------------------|---------|
| | | 240V | 480Y/277V | 600Y/347V | Susol | Metasol |
| MMS-100S-17 | 11~17 | 100 | 50 | 10 | MC-65 | MC-75a |
| MMS-100S-22 | 14~22 | 100 | 50 | 10 | MC-65 | MC-75a |
| MMS-100S-26 | 18~26 | 100 | 50 | 10 | MC-65 | MC-75a |
| MMS-100S-32 | 22~32 | 100 | 50 | 10 | MC-65 | MC-75a |
| MMS-100S-40 | 28~40 | 100 | 50 | 10 | MC-65 | MC-75a |
| MMS-100S-50 | 34~50 | 100 | 50 | 10 | MC-65 | MC-75a |
| MMS-100S-63 | 45~63 | 100 | 40 | 10 | MC-65 | MC-75a |
| MMS-100S-75 | 55~75 | 100 | 40 | 10 | MC-75 | MC-75a |
| MMS-100S-90 | 70~90 | 100 | 40 | 10 | MC-85 | MC-85a |
| MMS-100S-100 | 80~100 | 100 | 40 | 10 | MC-95 | MC-100a |

100AF rotary operation, High interruption

| Manual self-Protected | Adjustment range (A) | Short circuit rating (kA) | | | MC (Applied contactor) | |
|-----------------------|----------------------|---------------------------|-----------|-----------|------------------------|---------|
| | | 240V | 480Y/277V | 600Y/347V | Susol | Metasol |
| MMS-100H-17 | 11~17 | 100 | 65 | 25 | MC-65 | MC-75a |
| MMS-100H-22 | 14~22 | 100 | 65 | 20 | MC-65 | MC-75a |
| MMS-100H-26 | 18~26 | 100 | 65 | 20 | MC-65 | MC-75a |
| MMS-100H-32 | 22~32 | 100 | 65 | 20 | MC-65 | MC-75a |
| MMS-100H-40 | 28~40 | 100 | 65 | 20 | MC-65 | MC-75a |
| MMS-100H-50 | 34~50 | 100 | 65 | 20 | MC-65 | MC-75a |
| MMS-100H-63 | 45~63 | 100 | 50 | 10 | MC-65 | MC-75a |
| MMS-100H-75 | 55~75 | 100 | 50 | 10 | MC-75 | MC-75a |
| MMS-100H-90 | 70~90 | 100 | 50 | 10 | MC-85 | MC-85a |
| MMS-100H-100 | 80~100 | 100 | 50 | 10 | MC-95 | MC-100a |

LS contactor ready for IE3-rated motors



What is the IE3?

Motor is rated from IE1 through IE4 depends on its energy efficiency which means IE3 is more efficient compared to IE1 and IE2-rated motors. IE3-rated motor is not only more efficient than IE2-rated motor but it also has lower rated current and higher starting current & inrush current.



WHY IE3?

As part of the EU Environmental policy "20/30-20-20" strategy, the EU is committed to achieve the followings by 2020

- Reduce greenhouse gas emissions by up to 30 %
- Increase the share of renewable energy to 20 % and
- Boost energy efficiency by 20% in general. IEC 60034-30 standard specifies IE classes for motors in accordance with the above requirements.
- IEC 60034-30-1 standard
 - IE1 Standard Efficiency
 - IE2 High Efficiency
 - **IE3 Premium Efficiency**
 - IE4 Super Premium Efficiency



IE3 motors can be associated with standard starter solutions, like contactor, manual motor starter. During the starting the IE3 motor, Inrush and starting current are increased compared with IE2 motor. The increased inrush and starting current can affect the selection of the electrical device.

In order to secure the highest efficiency in your electrical system, it is strongly recommended to use the more efficient IE3 class product.

LS contactors are already compliant with IE3.



Dimension

3-pole contactors 18AF/22AF

[mm]

MC-6a~18a AC

1NO or 1NC

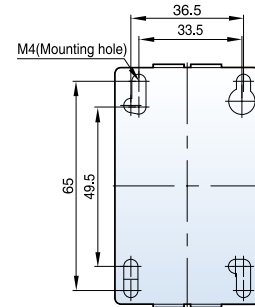
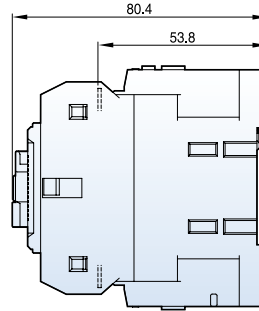
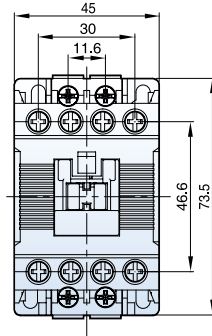

0.3kg

MC-6a~18a DC

1NO or 1NC

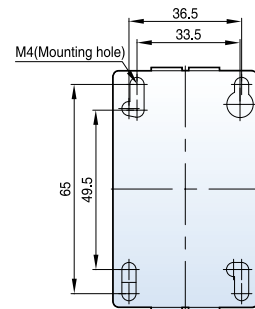
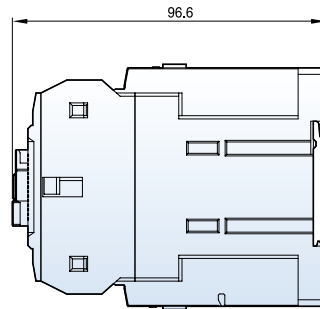
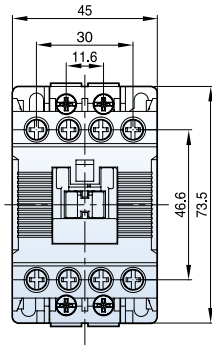

0.4kg

MC-9b~22b AC

1NO1NC

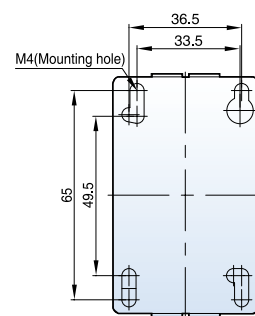
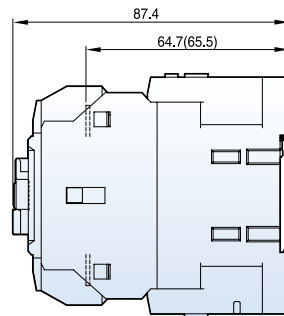
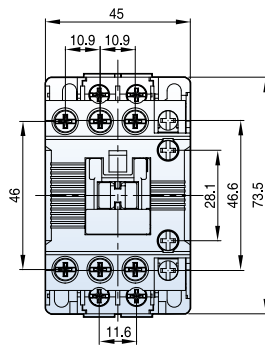

* () MC-18b, 22b

0.3kg

MC-9b~22b DC

1NO1NC

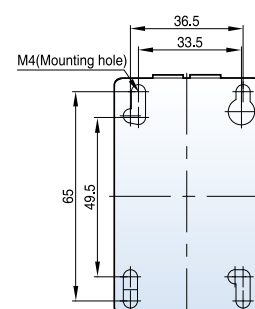
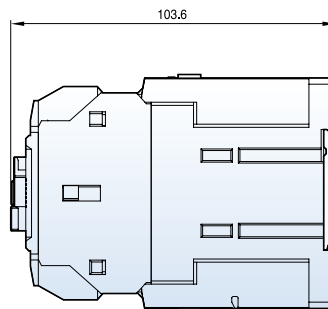
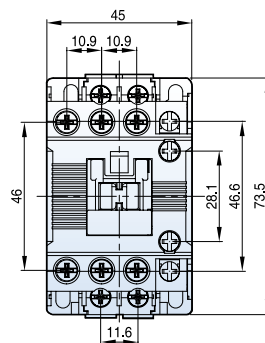

0.41kg

3-pole contactors 40AF

[mm]

MC-32a~40a AC

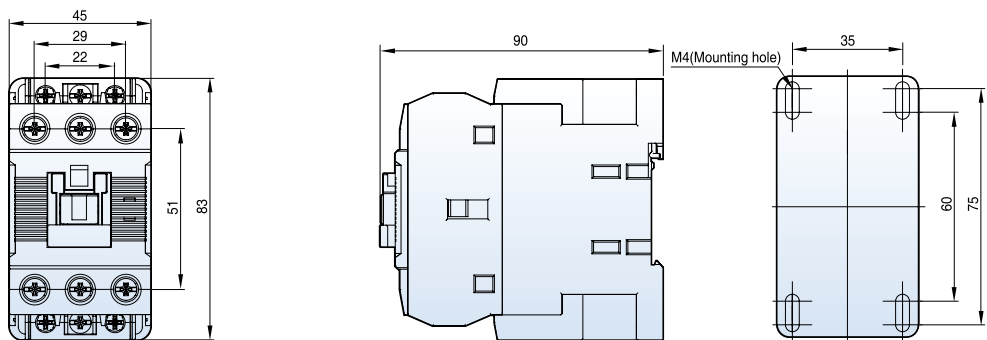

0.4kg

MC-32a~40a DC

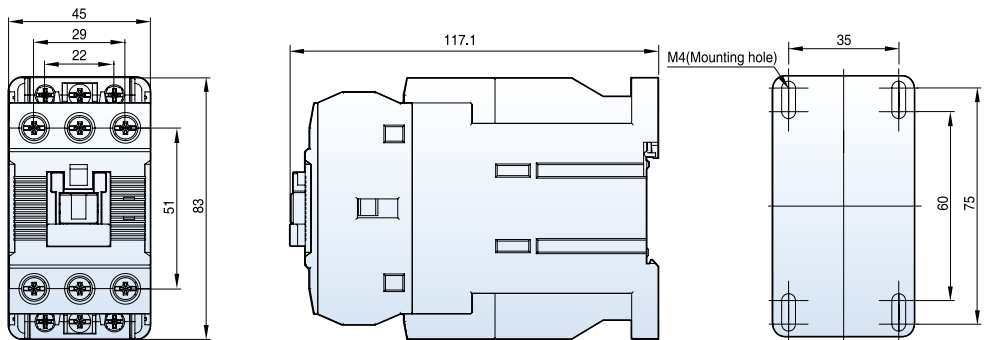

0.6kg

MC-32a~40a AC

2NO2NC

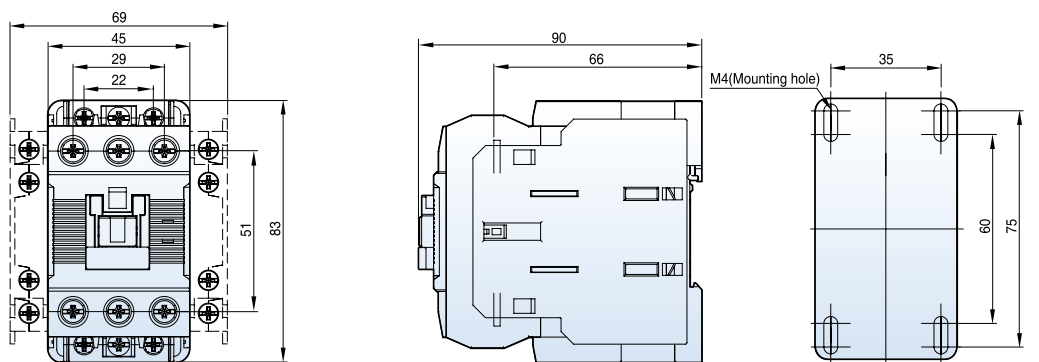

0.5kg

MC-32a~40a DC

2NO2NC

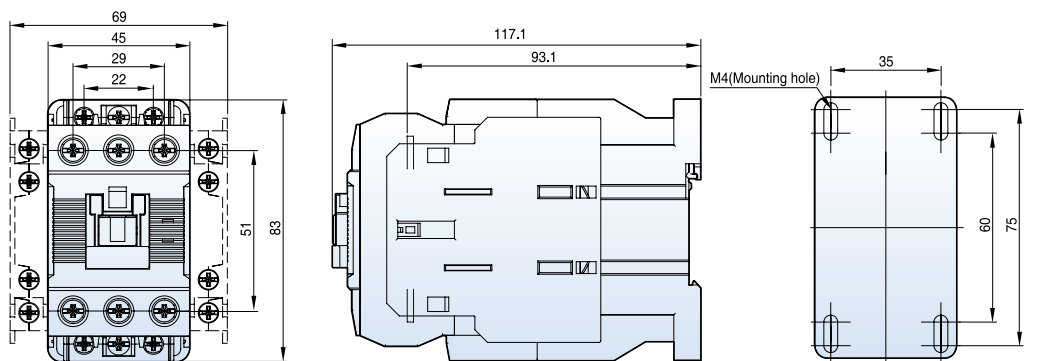

0.8kg

Dimension

3-pole contactors 65AF

[mm]

MC-50a~65a AC

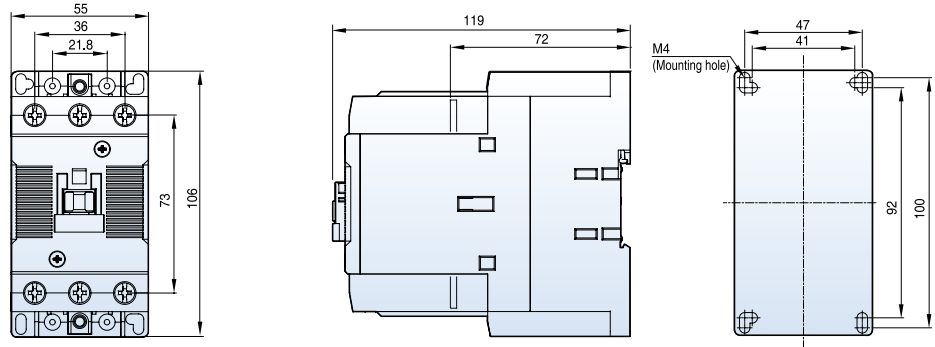

0.9kg

MC-50a~65a DC

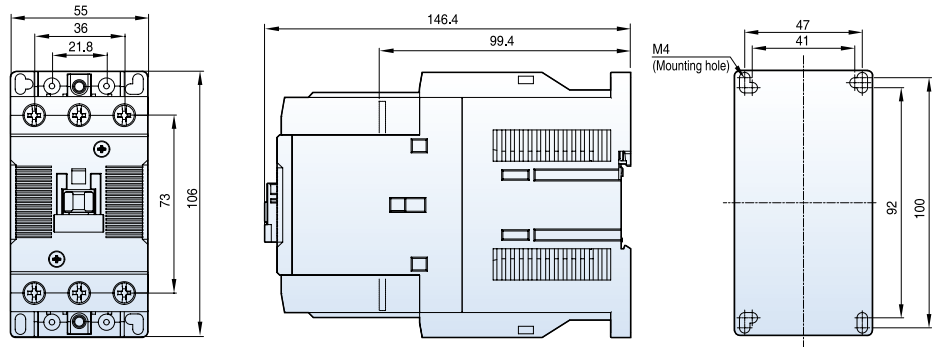

1.2kg

MC-50a~65a AC

2NO2NC

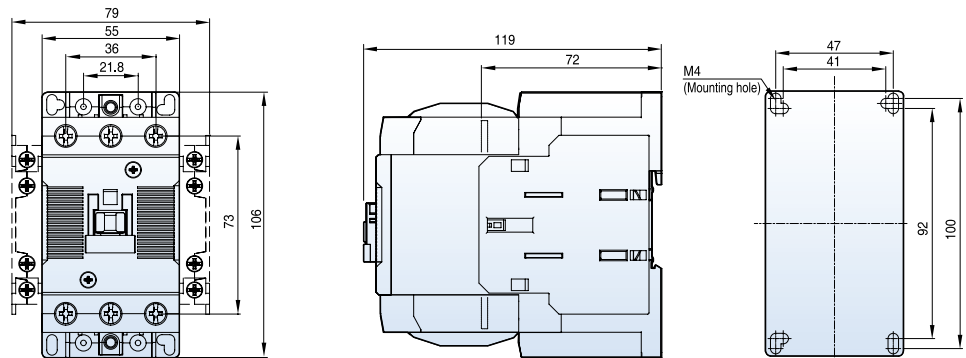

1kg

MC-50a~65a DC

2NO2NC

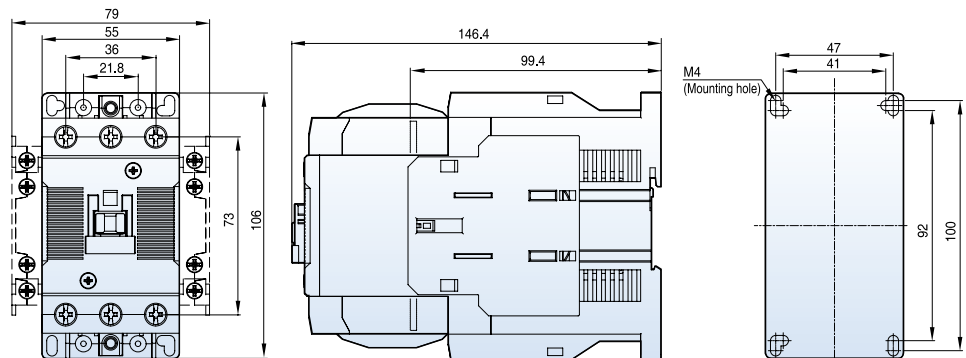

1.3kg

3-pole contactors 100AF

[mm]

MC-75a~100a AC

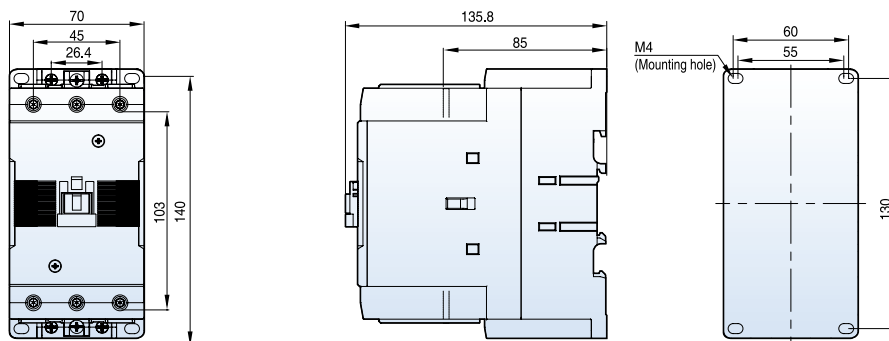

1.8kg

MC-75a~100a DC

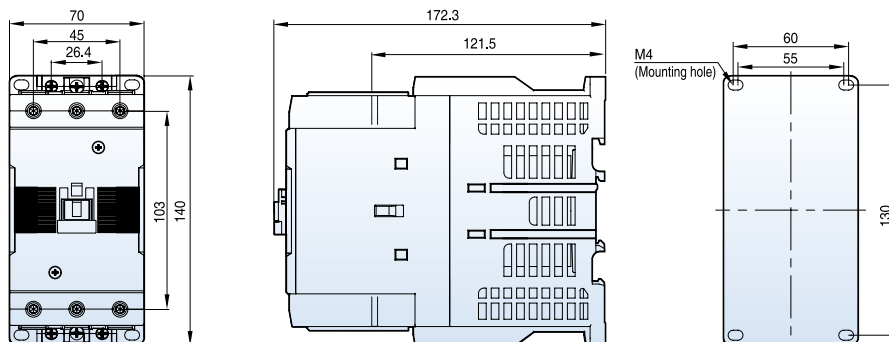

2.7kg

MC-75a~100a AC

2NO2NC

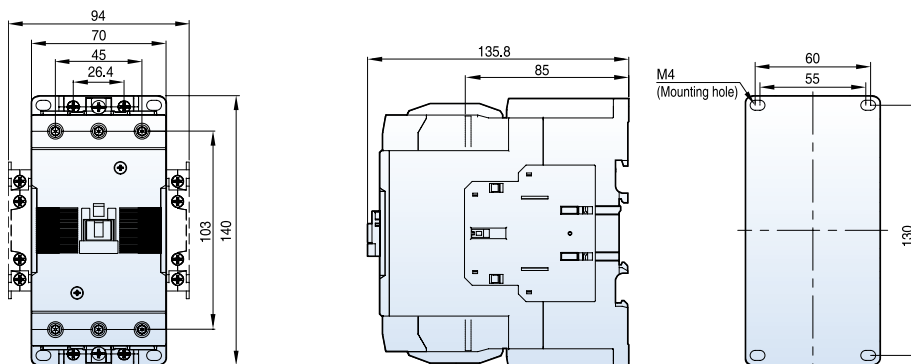

1.9kg

MC-75a~100a DC

2NO2NC

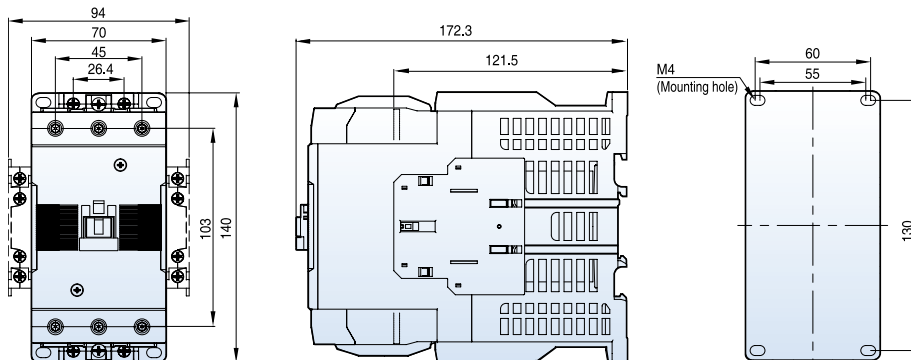

2.8kg

Dimension

3-pole contactors 150AF~400AF

[mm]

MC-130a

MC-150a

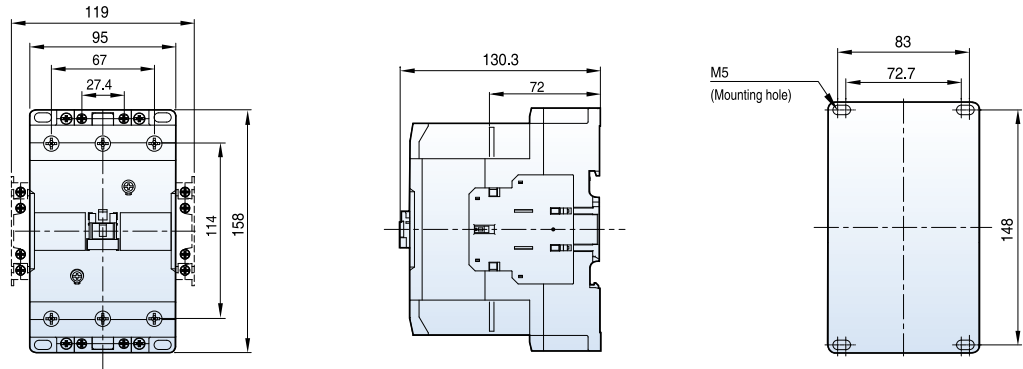

2.4kg

MC-185a

MC-225a

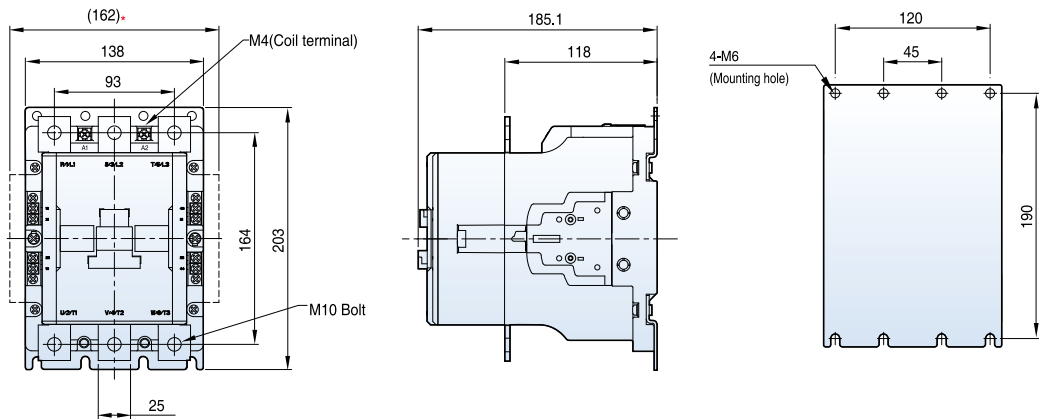

5.4kg

MC-265a

MC-330a

MC-400a

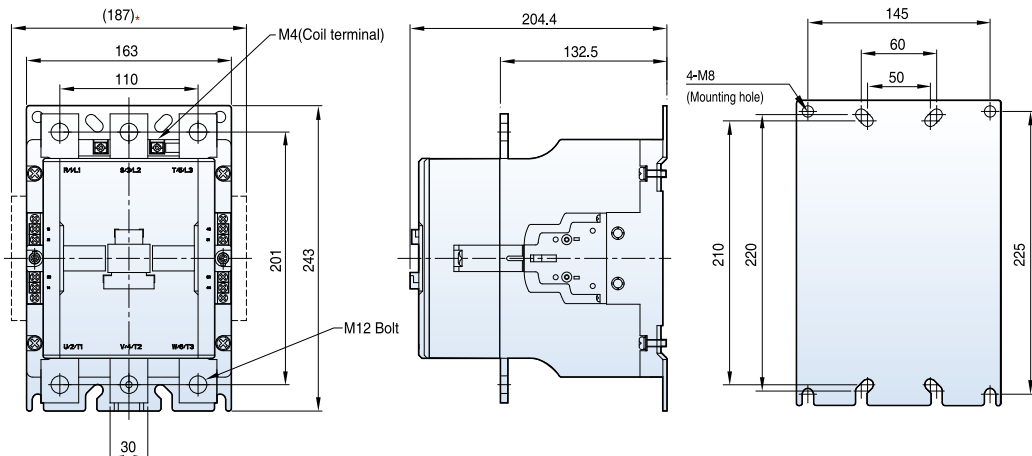

* Optional auxiliary contact unit (side mount type)

9.2kg

3-pole contactors 800AF~2650AF

[mm]

- MC-500a
- MC-630a
- MC-800a
- MCI-900
- MCI-1050

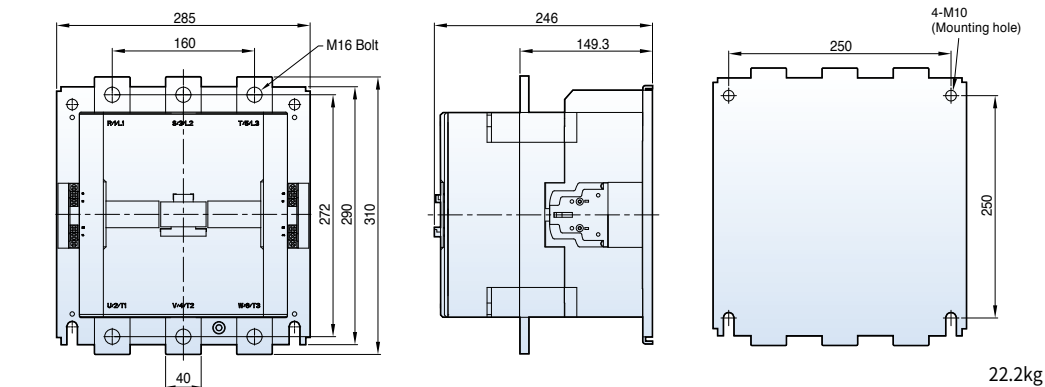

- MC-1260a
- MCI-1260

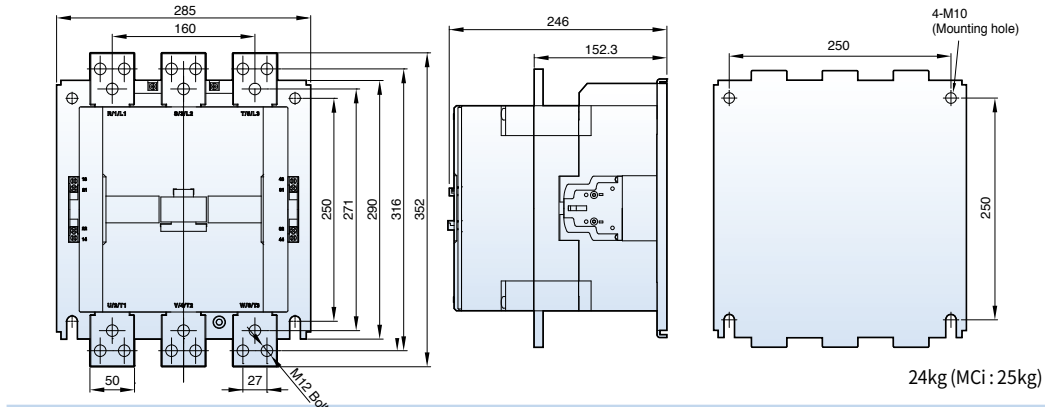

- MC-1400a
- MC-1700a
- MC-2100a
- MCI-1700
- MCI-2100

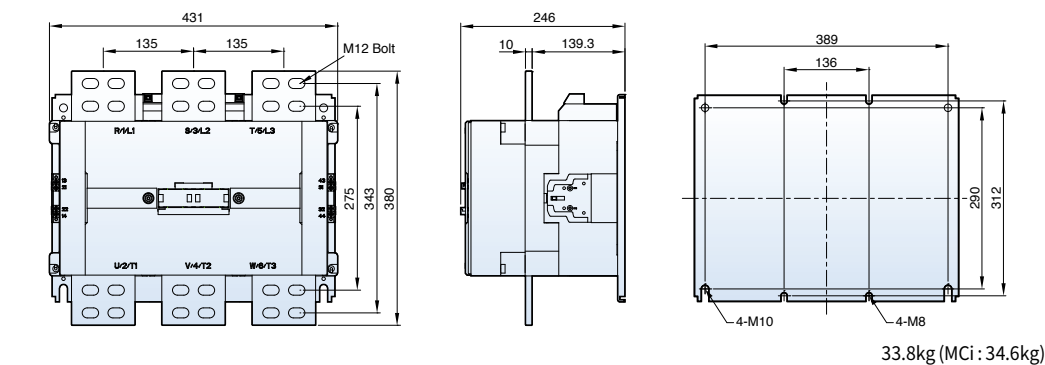

- MC-2650a
- MCI-2650

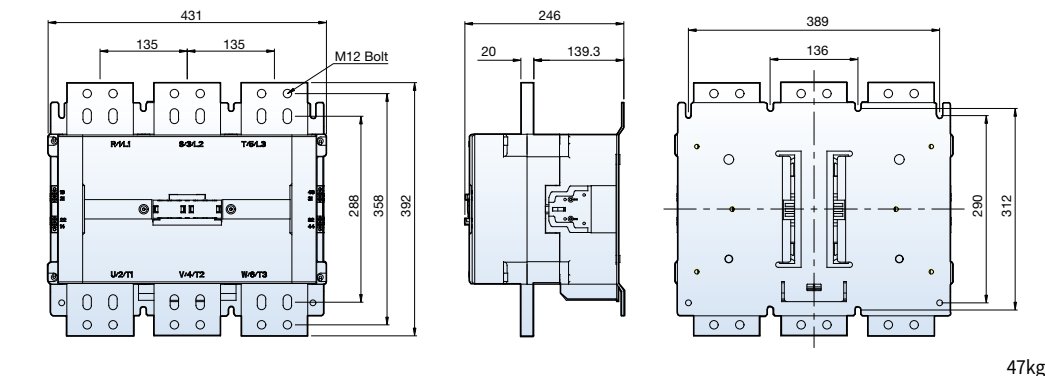

Dimension

Motor starters 18AF~40AF

[mm]

MS-6a~18a

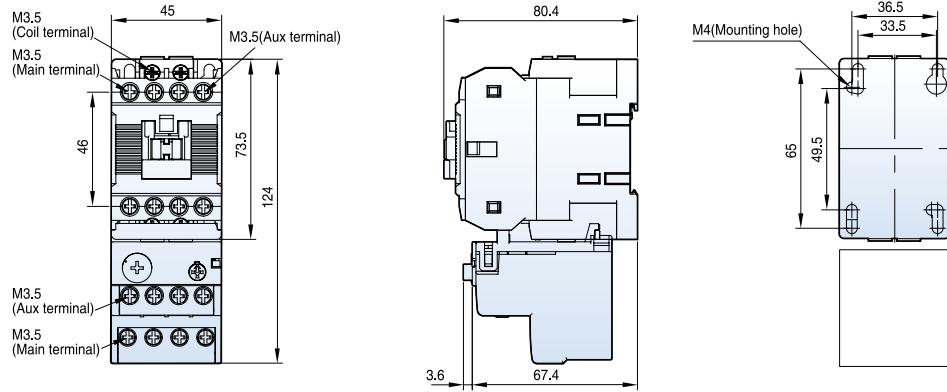

0.5kg

MS-9b~22b

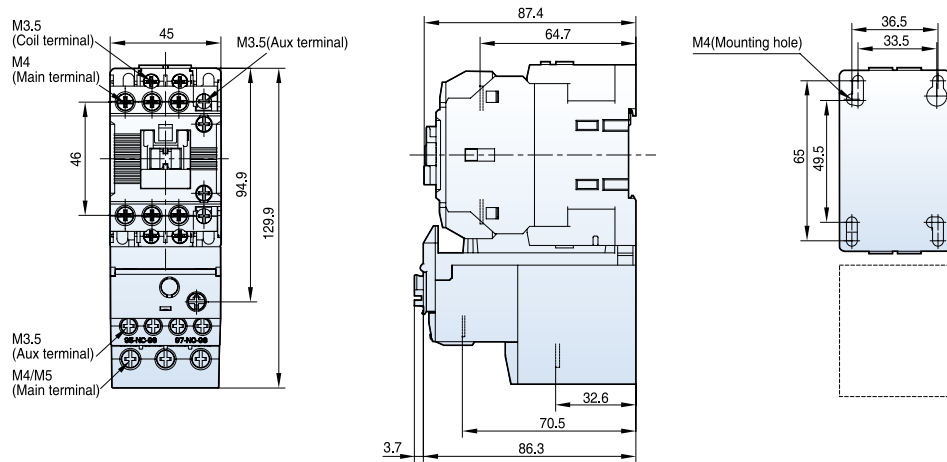

0.5kg

MS-32a~40a

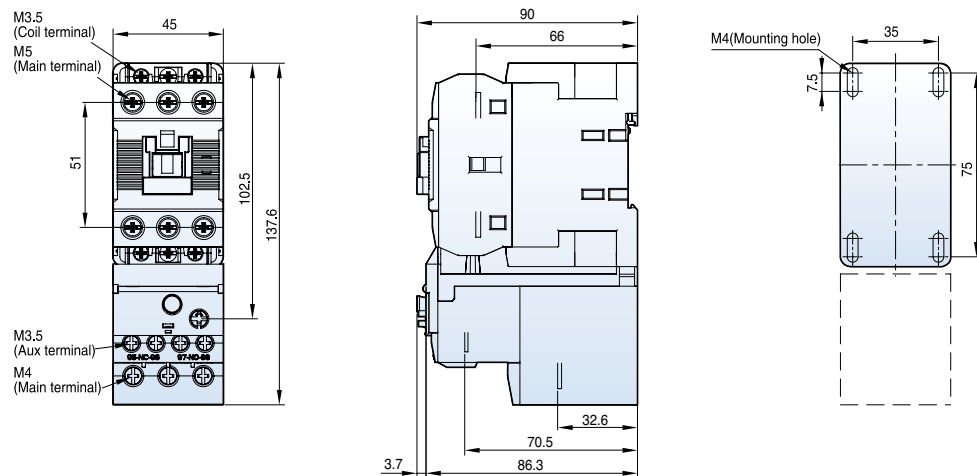

0.6kg

Motor starters 65AF~150AF

[mm]

MS-50a~65a

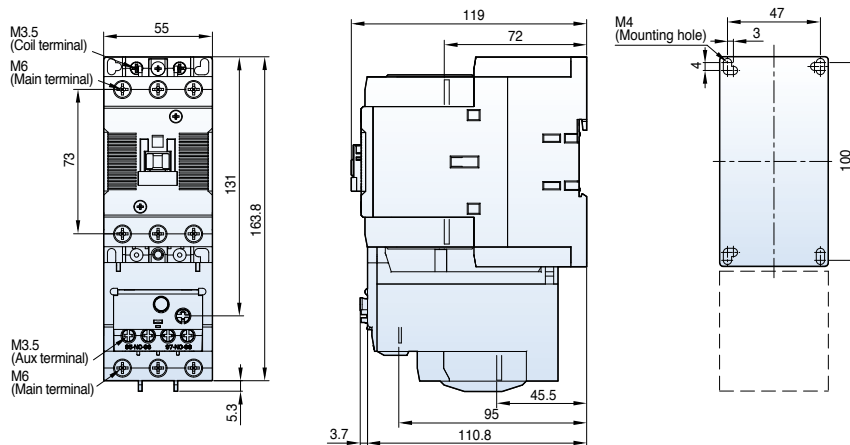

1.3kg

MS-75a~100a

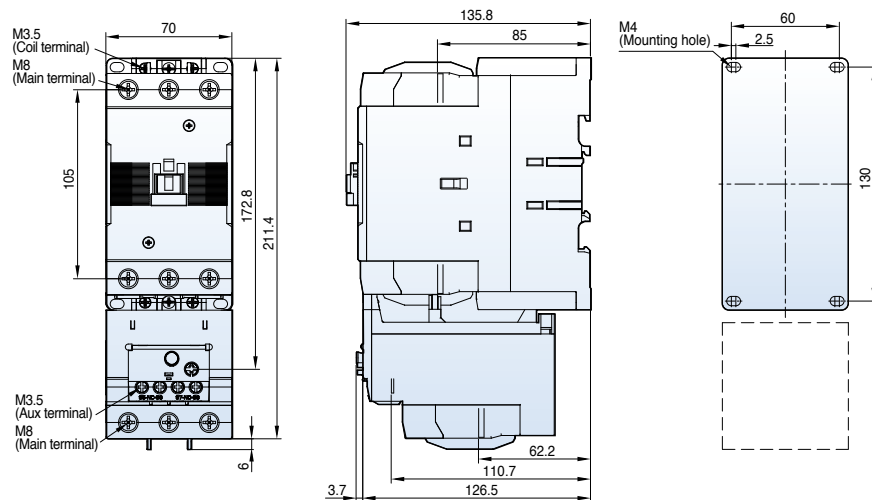

2.3kg

MS-130a

MS-150a

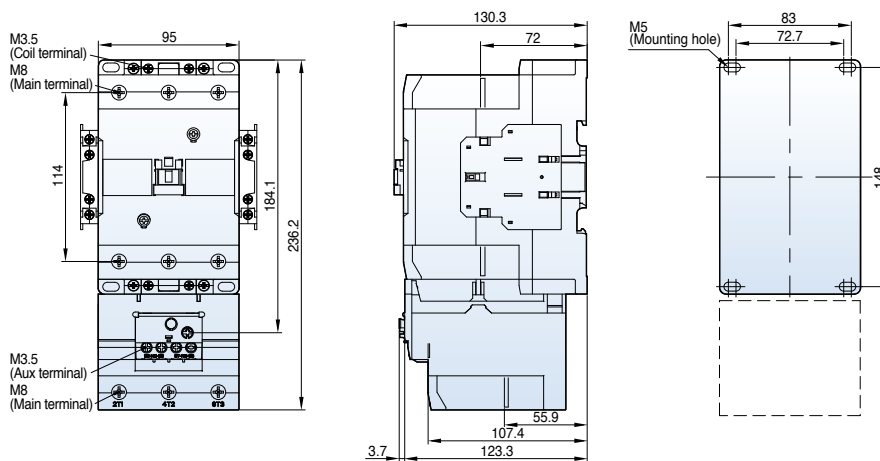

2.9kg

Dimension

Motor starters 185AF~800AF

[mm]

MS-185a

MS-225a

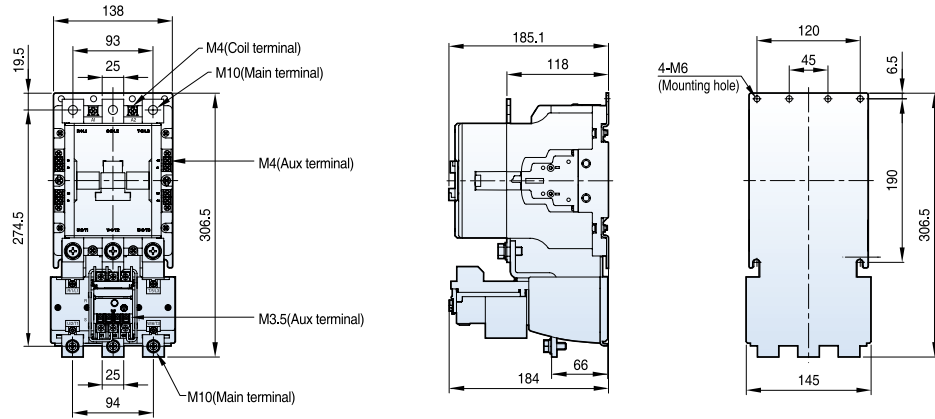

7.9kg

MS-265a

MS-330a

MS-400a

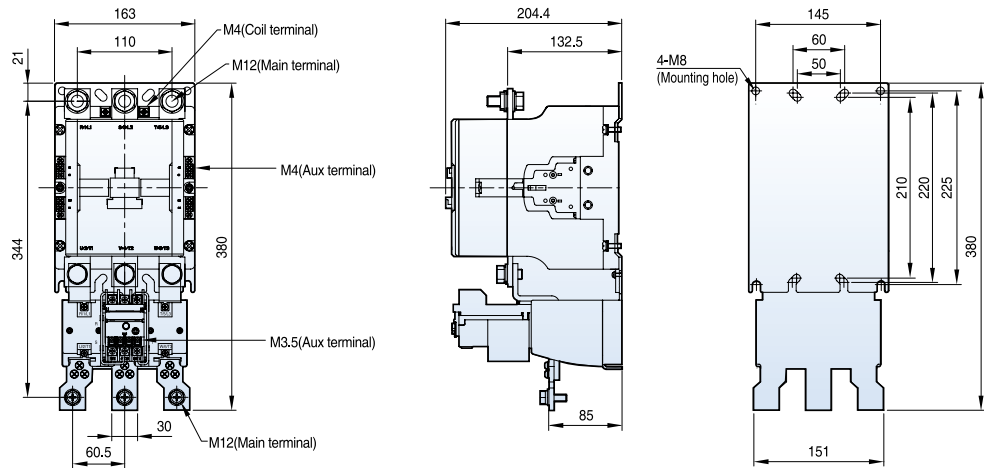

11.8kg

MS-500a

MS-630a

MS-800a

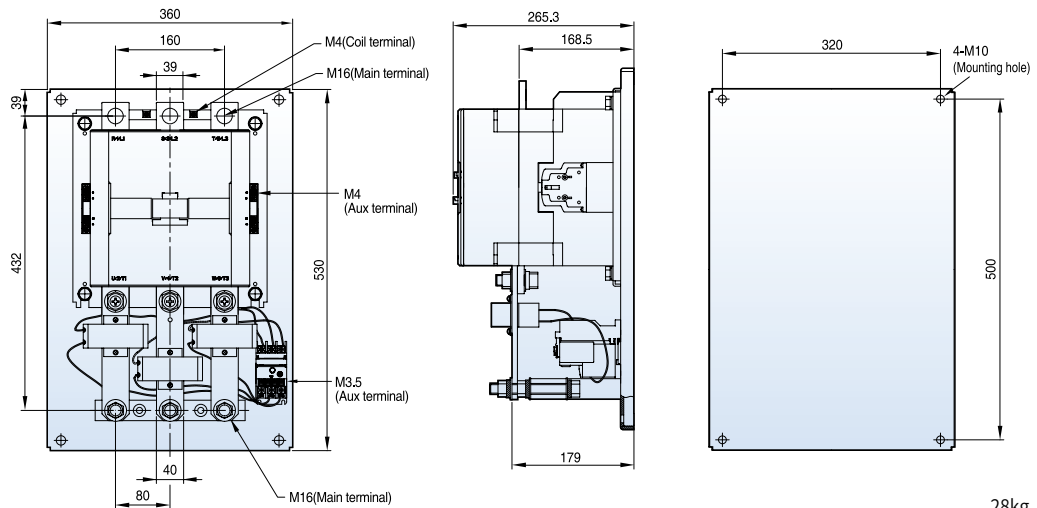

28kg

Reversing contactors and starters 18AF

[mm]

MC-6aR~18aR AC

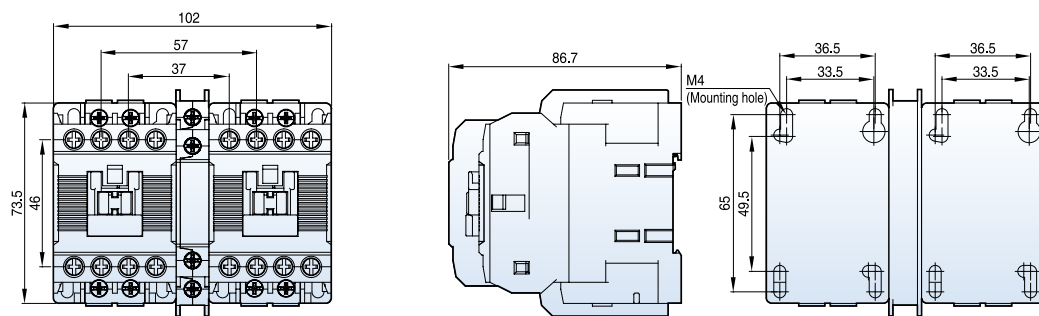

0.7kg

MC-6aR~18aR DC

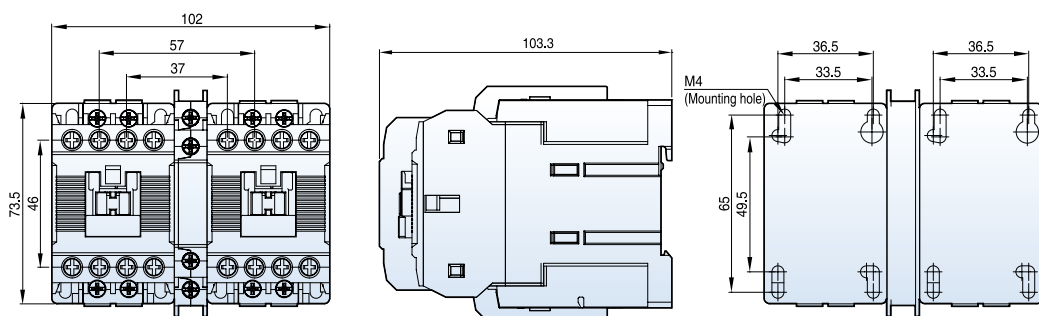

1kg

MS-6aR~18aR AC

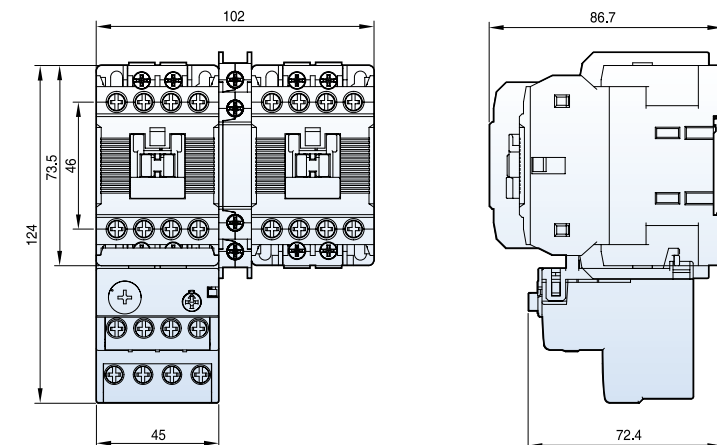

0.9kg

Dimension

Reversing contactors and starters 22AF

[mm]

MC-9bR-22bR AC

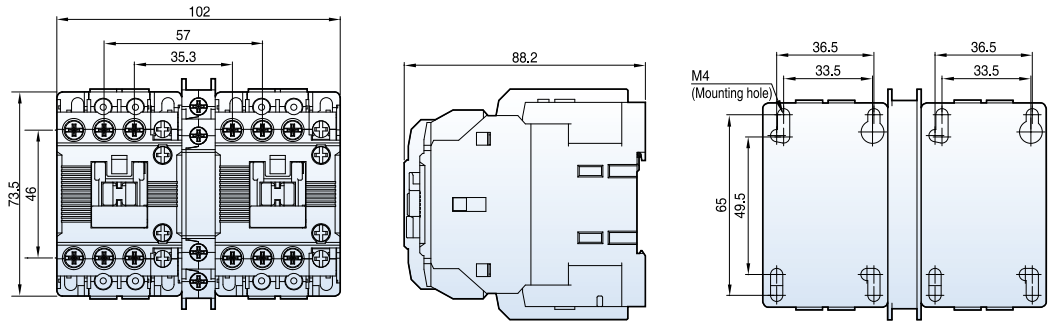

0.7kg

MC-9bR-22bR DC

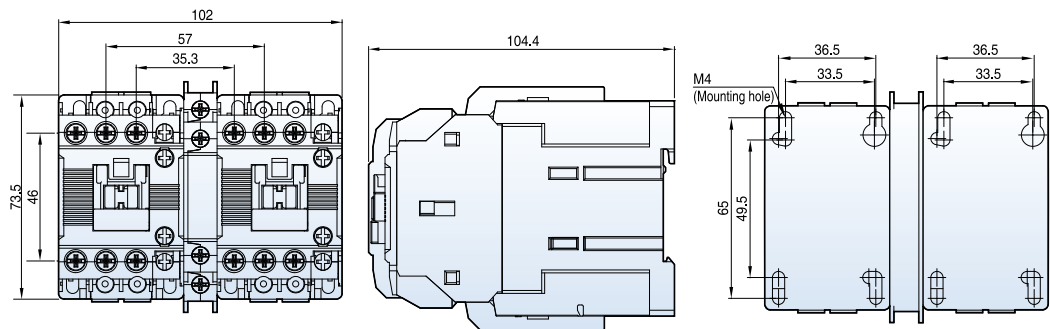

1.1kg

MS-9bR-22bR AC

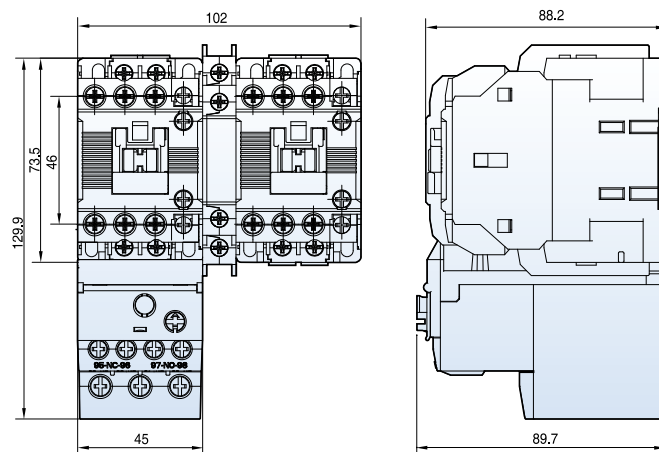

1.3kg

Reversing contactors and starters 40AF

[mm]

MC-32aR~40aR AC

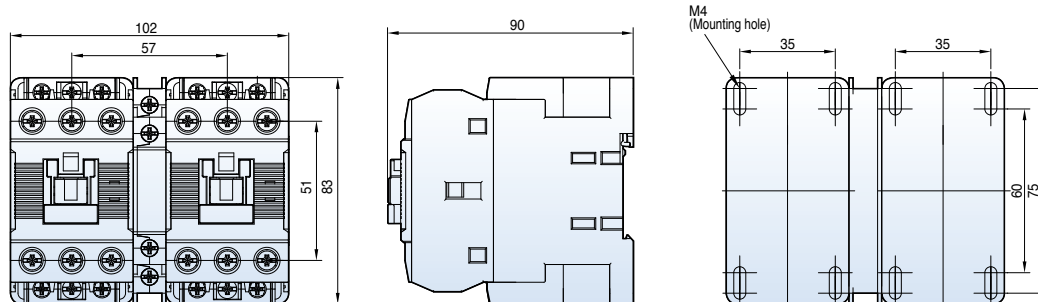

0.9kg

MC-32aR~40aR DC

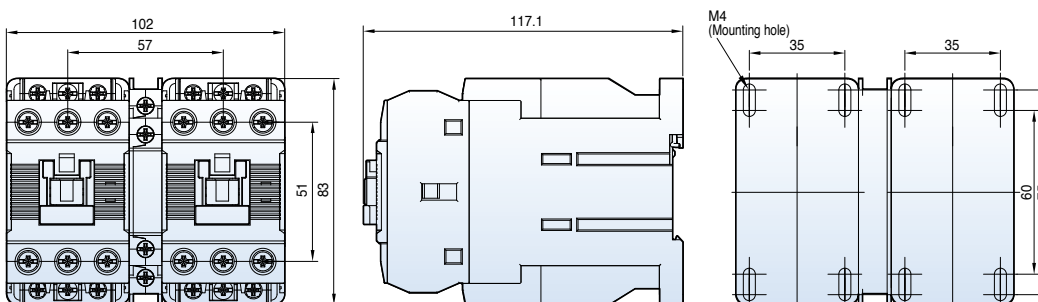

1.4kg

MS-32aR~40aR AC

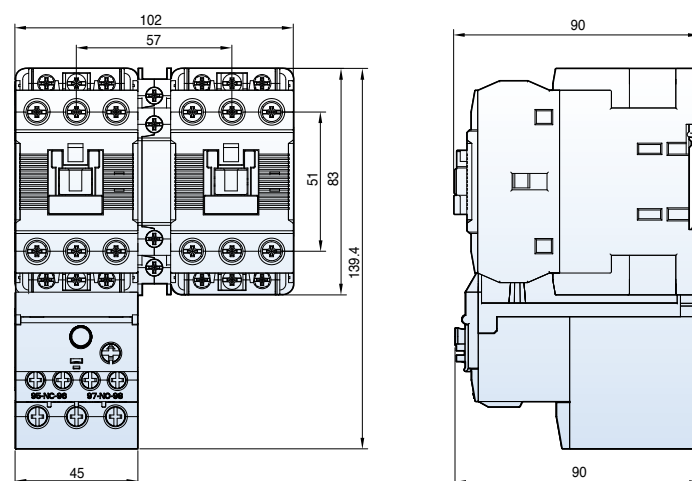

1.1kg

Dimension

Reversing contactors and starters 65AF

[mm]

MC-50aR~65aR AC

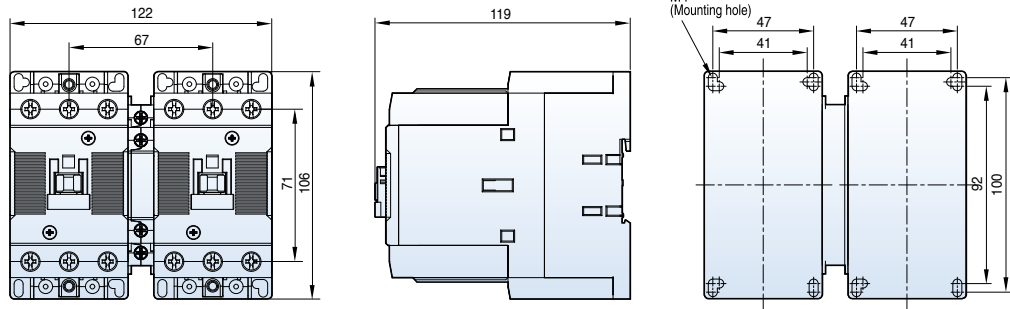

1.8kg

MC-50aR~65aR DC

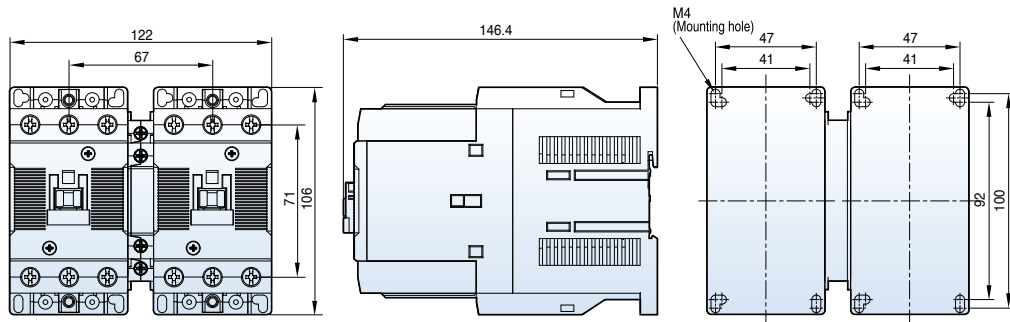

2.4kg

MS-50aR~65aR AC

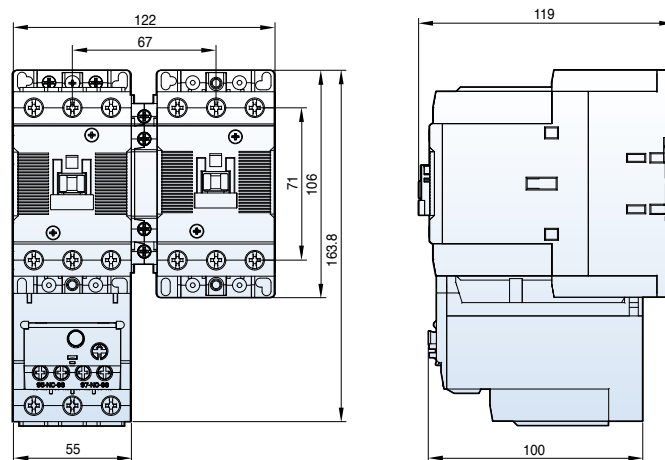

1.9kg

Reversing contactors and starters 100AF

[mm]

MC-75aR-100aR AC

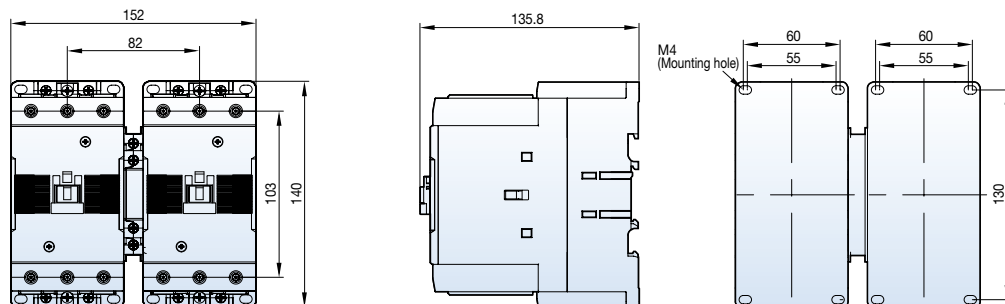

3.3kg

MC-75aR-100aR DC

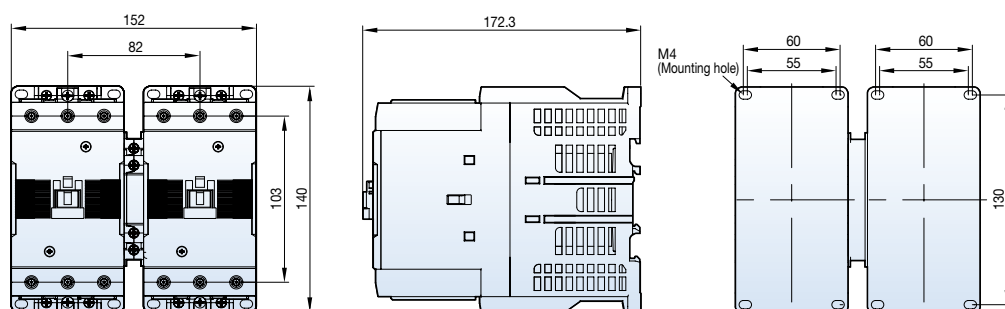

5.2kg

MS-75aR-100aR AC

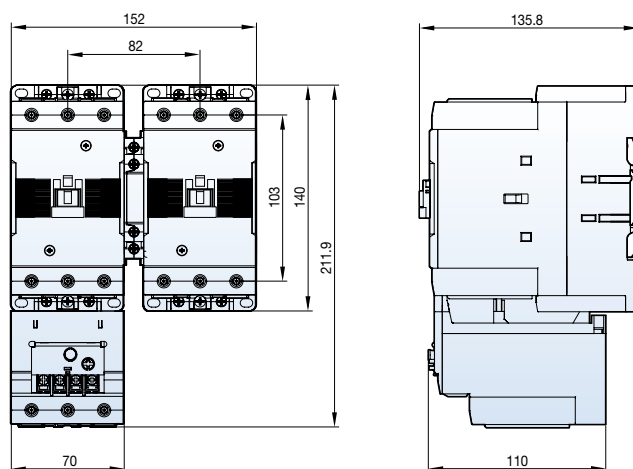

3.8kg

Dimension

Reversing contactors and starters 150~800AF

[mm]

MC-130aR

MC-150aR

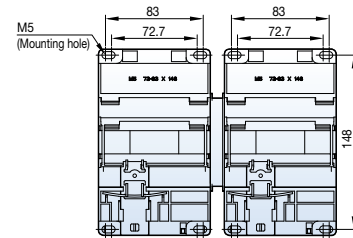
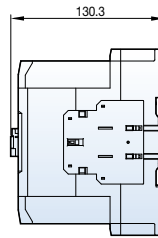
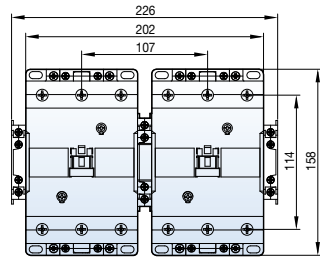

4.3kg

MC-185aR

MC-225aR

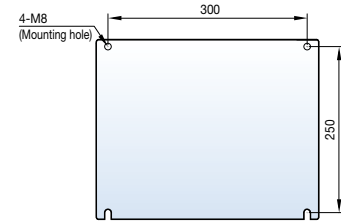
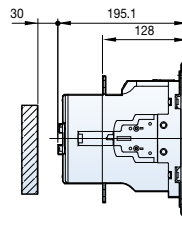
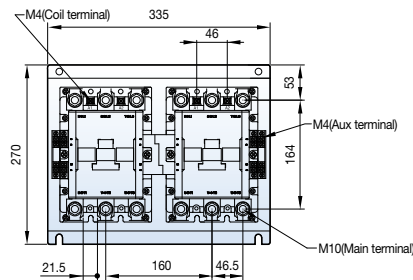

12.9kg

MC-265aR

MC-330aR

MC-400aR

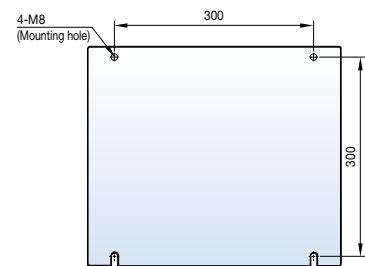
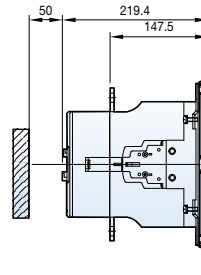
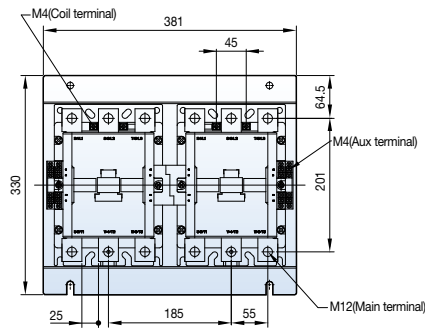

21.4kg

MC-500aR

MC-630aR

MC-800aR

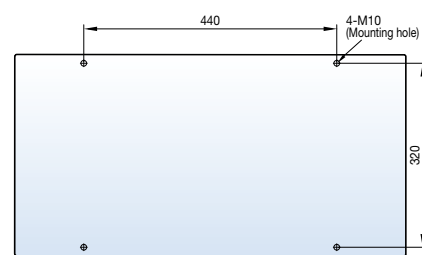
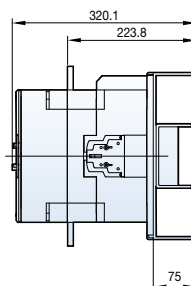
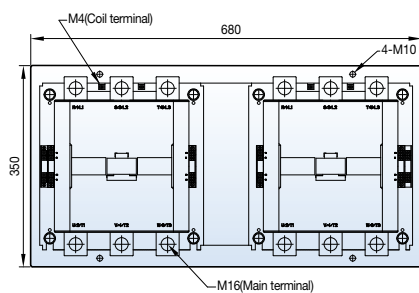

60kg

Reversing contactors and starters 150~400AF

[mm]

- MS-130aR AC
- MS-150aR AC

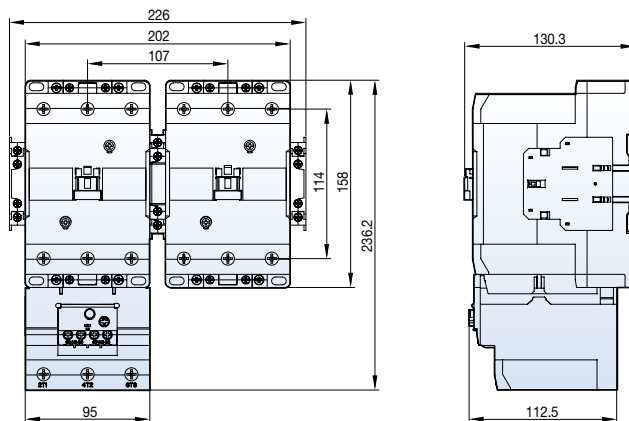

5kg

- MS-185aR AC
- MS-225aR AC

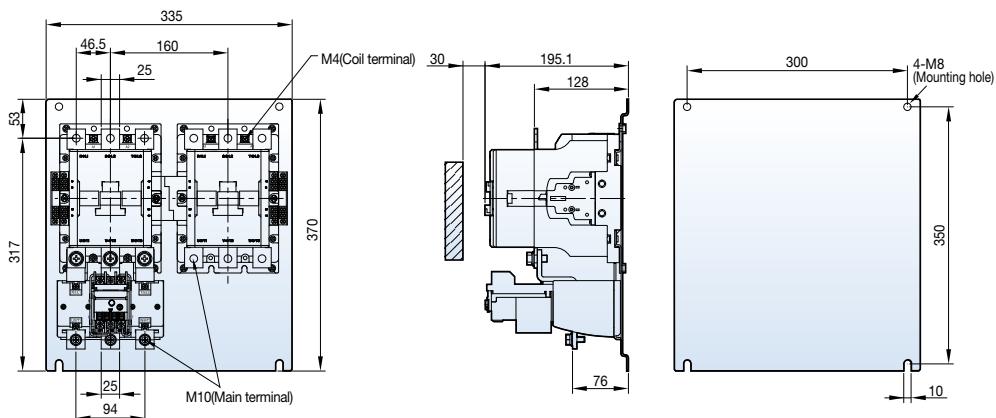

15.5kg

- MS-265aR DC
- MS-330aR DC
- MS-400aR DC

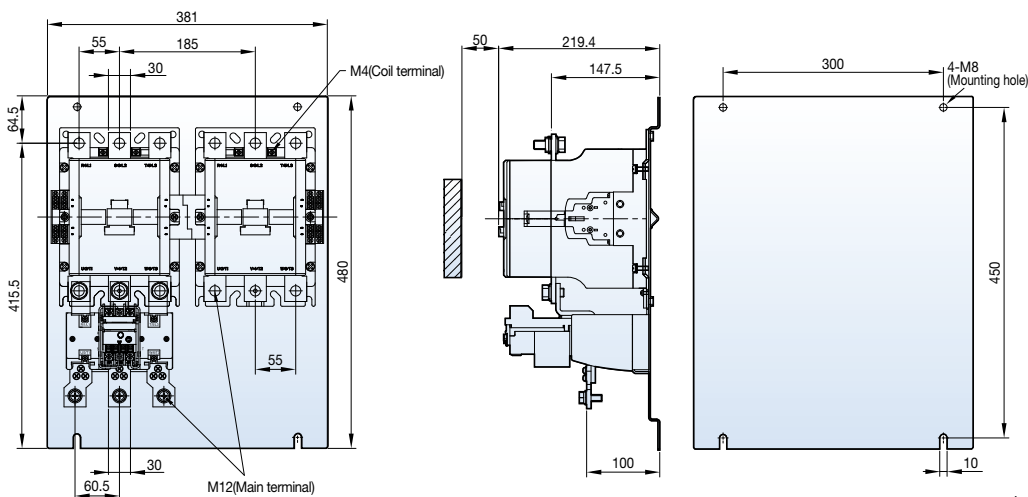

23kg

Dimension

Contactors relays

[mm]

MR-4 (D)

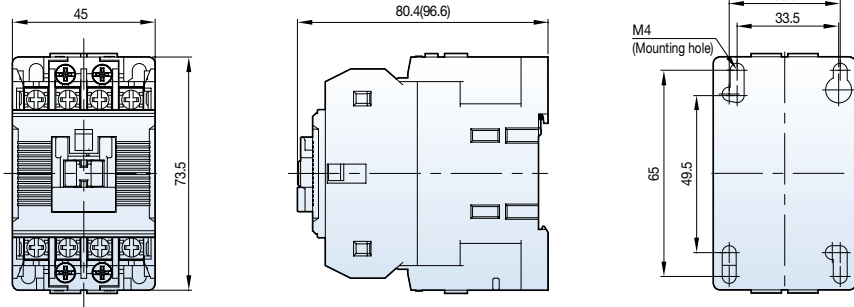

284g

MR-6 (D)

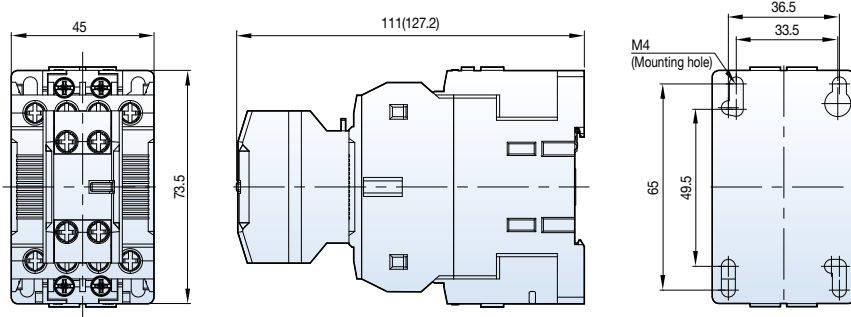

315g

MR-8 (D)

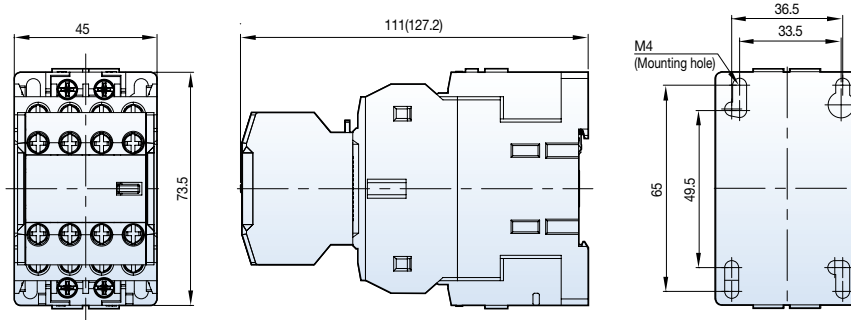

339g

Composition

| | |
|------|--|
| MR-4 | |
| MR-6 | |
| MR-8 | |

Note) 1. UA-2: Auxiliary contact units 2. UA-4: Auxiliary contact units

- Please refer to the contact diagram represented on catalog when contactor relays MR-4, 4D and auxiliary contact units UA-2,4 are purchased separately.
- Be sure to order the auxiliary contact units separately except for the above contact units. • (): Dimension for DC control contactor relays

Latching contactors 18AF/22AF

[mm]

MC-6a-18a AC
1NO or 1NC + ML-65

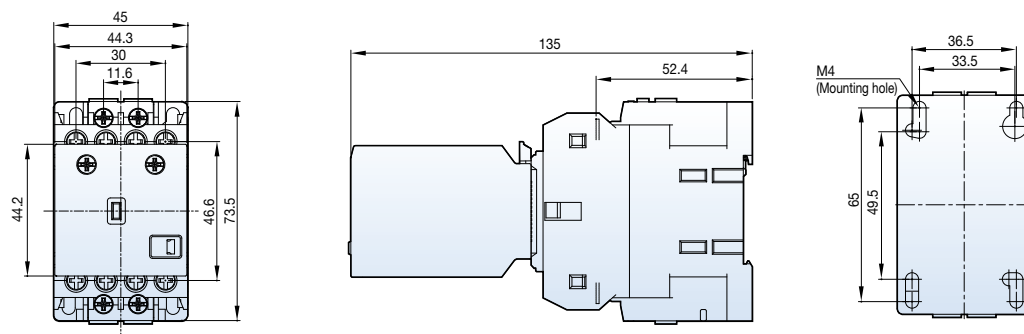

MC-6a-18a DC
1NO or 1NC + ML-65

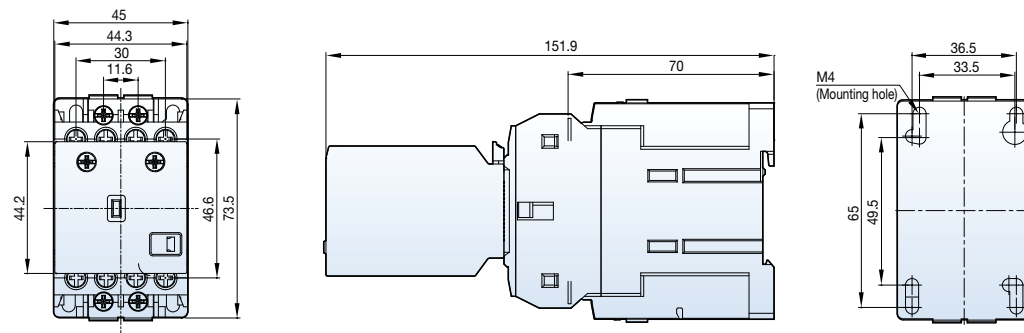

MC-9b-22b AC
1NO1NC + ML-65

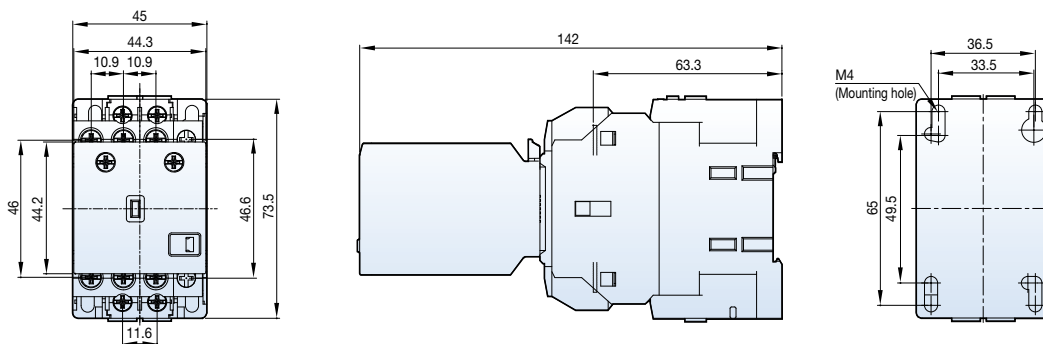

MC-9b-22b DC
1NO1NC + ML-65

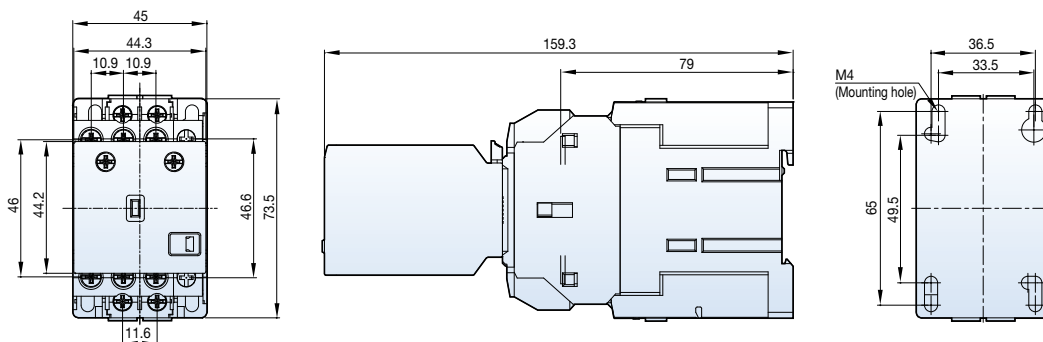

Dimension

Latching contactors 40AF

[mm]

MC-32a~40a AC
+ML-65

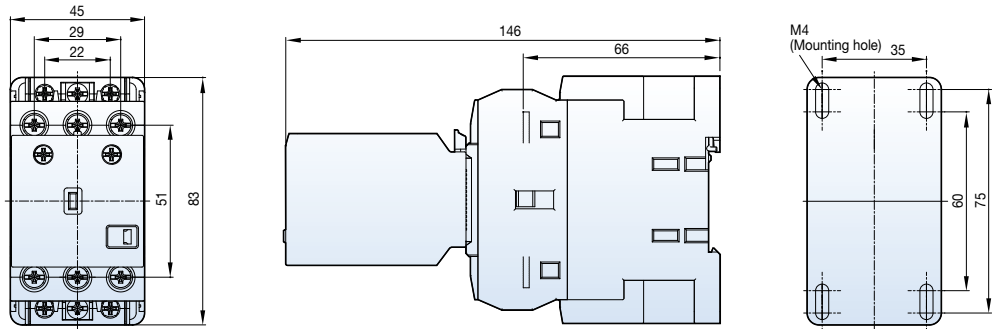

0.5kg

MC-32a~40a DC
+ ML-65

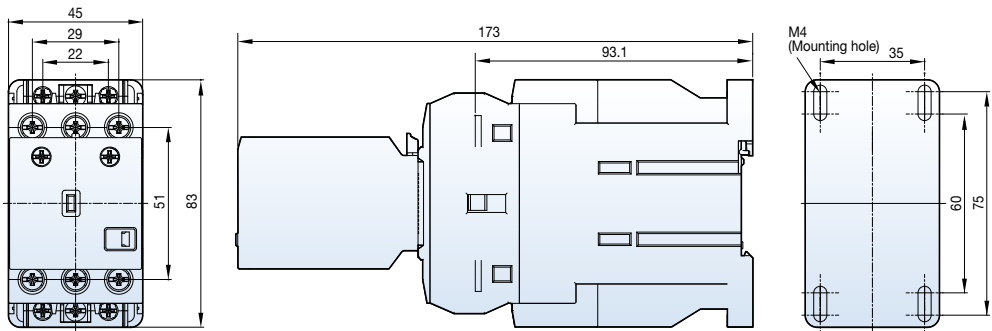

0.8kg

MC-32a~40a AC
2NO2NC + ML-65

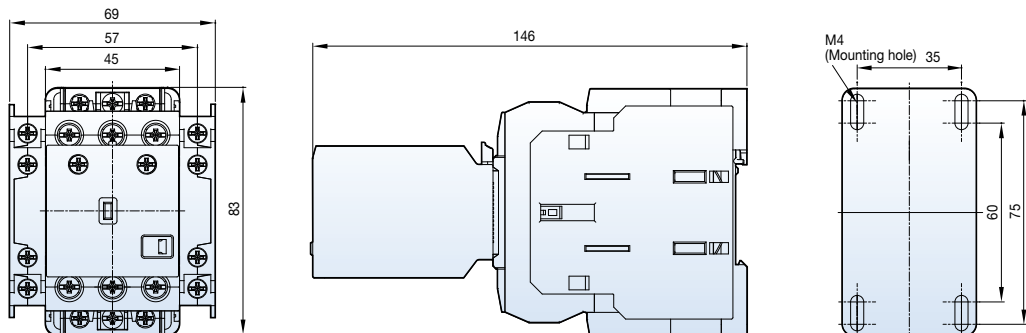

1kg

MC-32a~40a DC
2NO2NC + ML-65

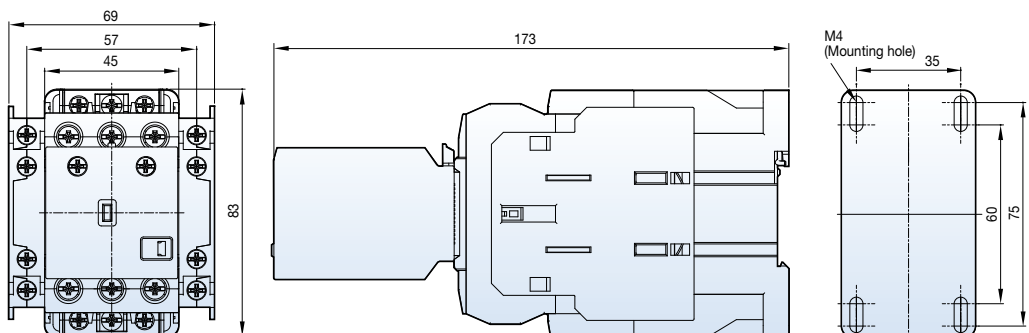

1.3kg

Latching contactors 65AF

[mm]

MC-50a~65a AC
+ ML-65

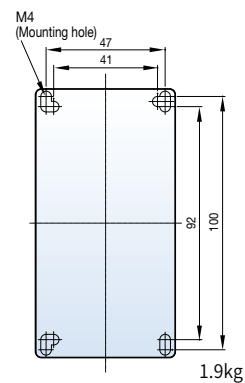
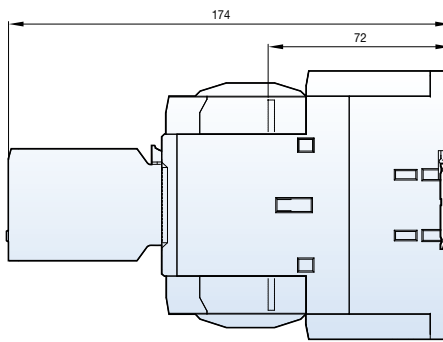
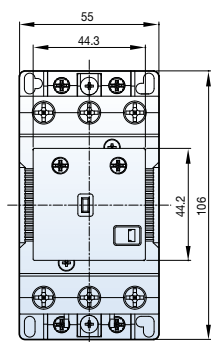

MC-50a~65a DC
+ ML-65

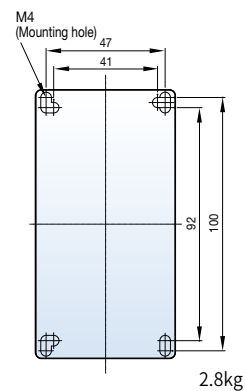
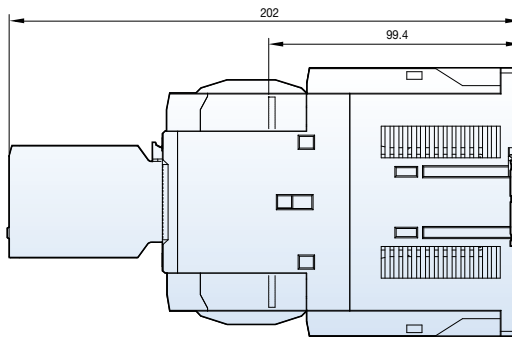
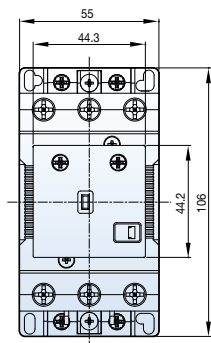

MC-50a~65a AC
2NO2NC + ML-65

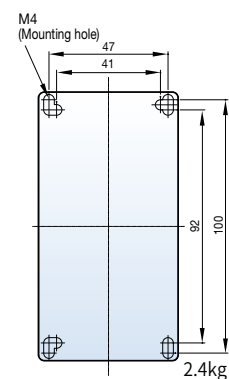
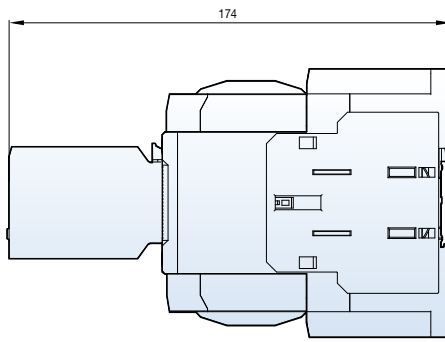
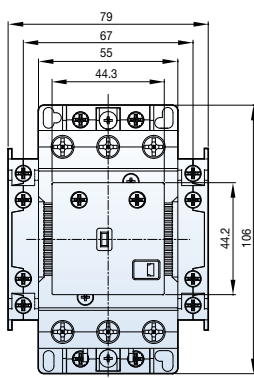

MC-50a~65a DC
2NO2NC + ML-65

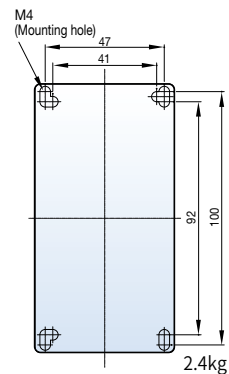
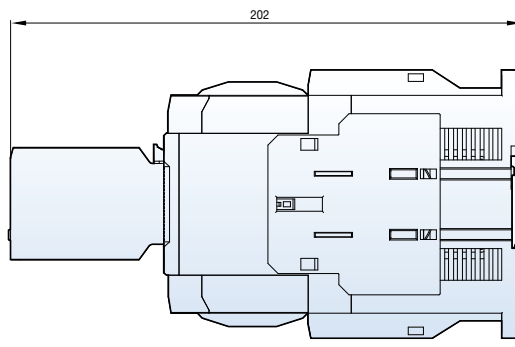
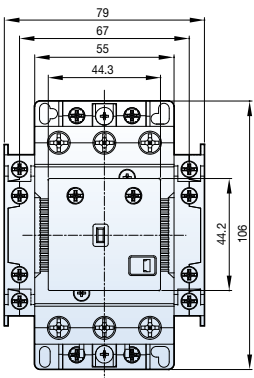

Dimension

Latching contactors 100AF

[mm]

MC-75a~100a AC

+ ML-150

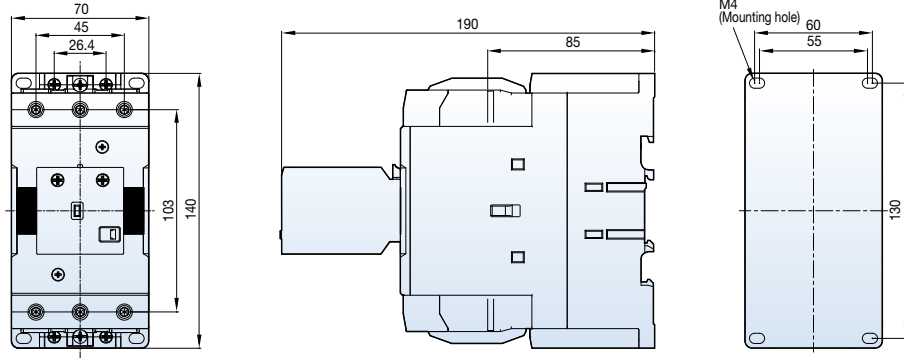

MC-75a~100a DC

+ ML-150

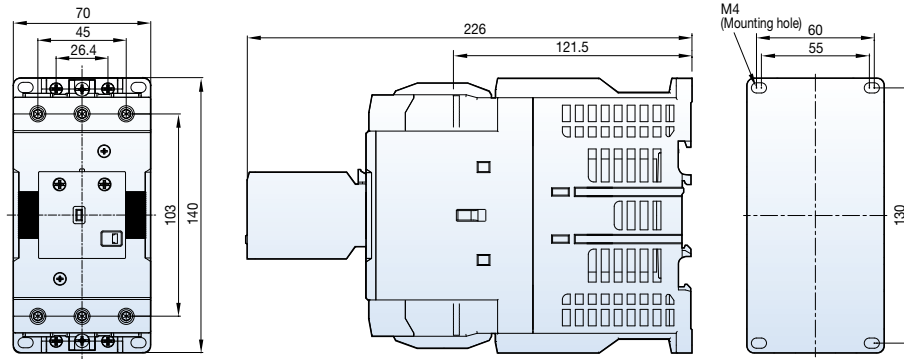

MC-75a~100a AC

2NO2NC + ML-150

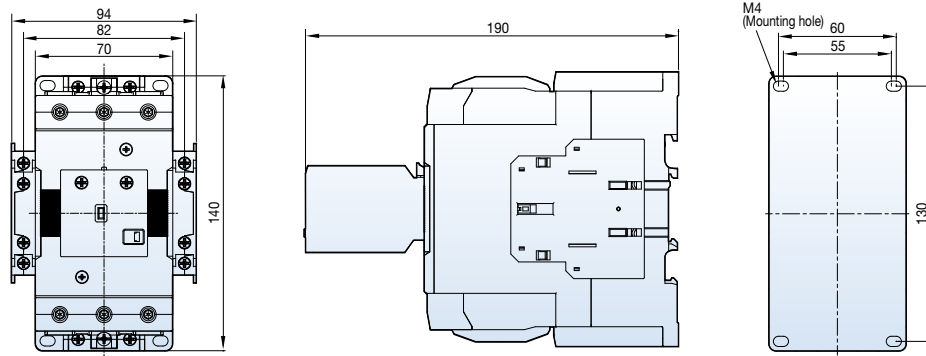

MC-75a~100a DC

2NO2NC + ML-150

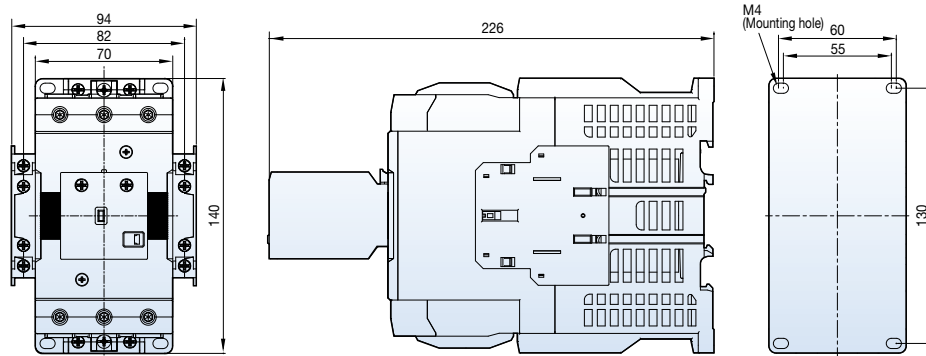

Latching contactors 150AF~400AF

[mm]

MC-130a~150a
2NO2NC + ML-150

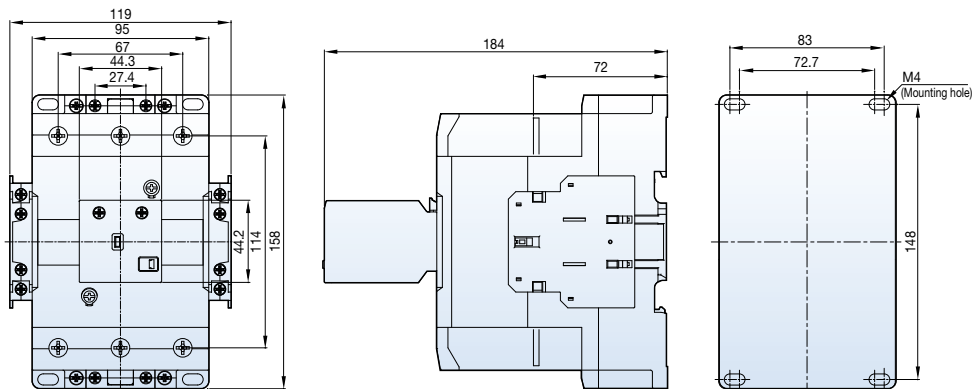

MC-185a
MC-225a

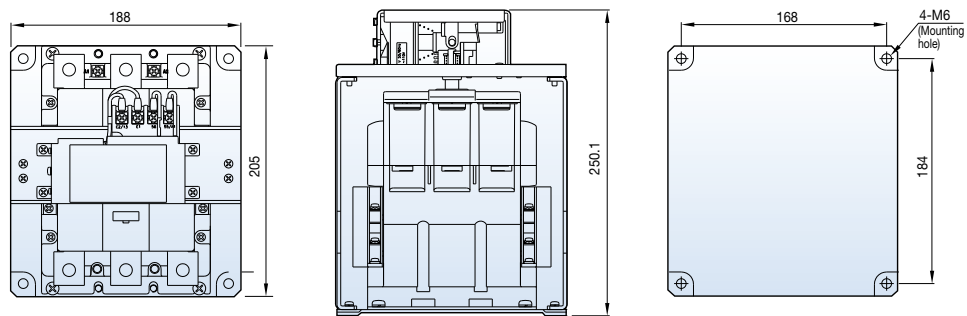

7.4kg

MC-265a
MC-330a
MC-400a

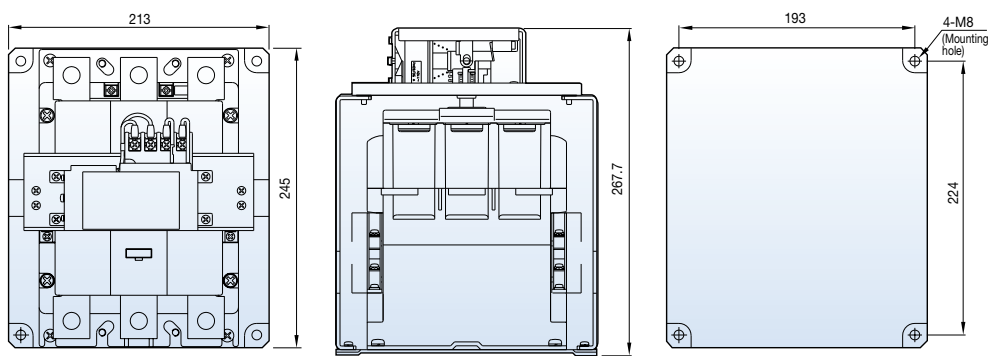

11.6kg

Composition

MC-185a/L~400a/L

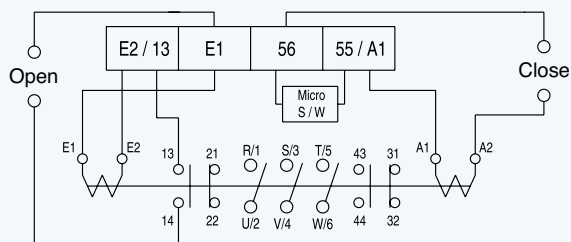

Dimension

4-pole contactors MC-6a/4~22a/4

[mm]

MC-6a/4~18a/4 AC

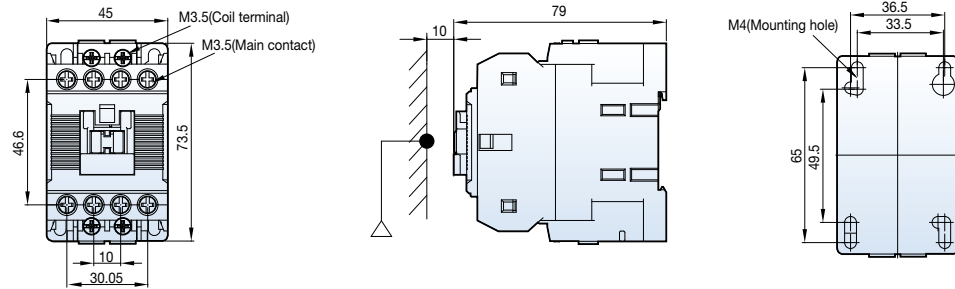

0.3kg

MC-6a/4~18a/4 DC

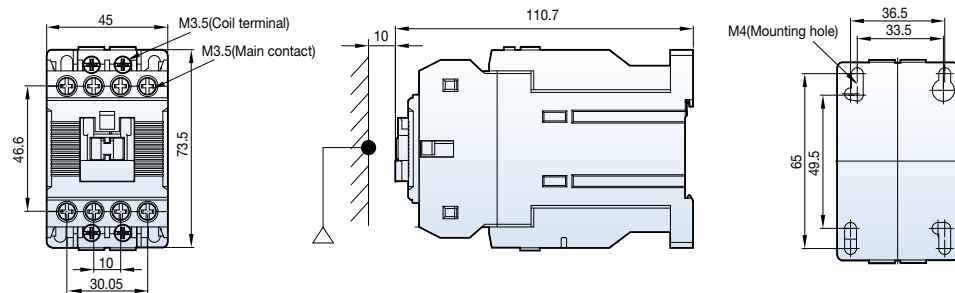

0.45kg

MC-22a/4 AC

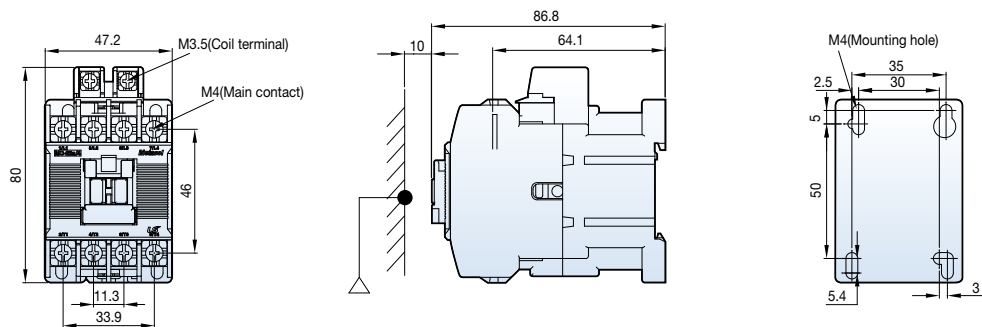

0.4kg

MC-22a/4 DC

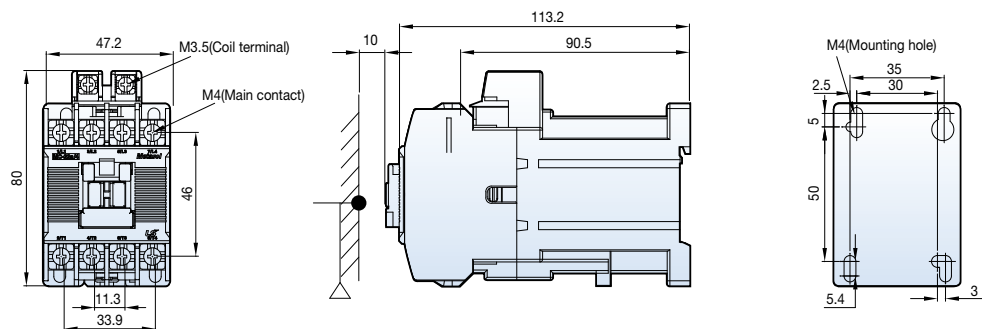

0.5kg

4-pole contactors MC-32a/4~85a/4

[mm]

MC-32a/4~40a/4 AC

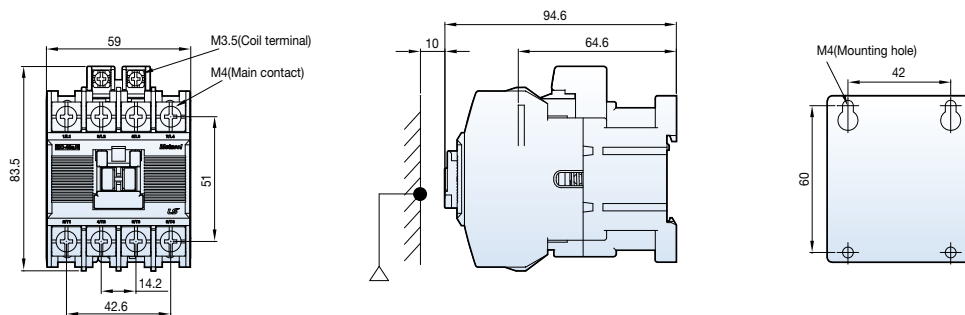

0.59kg

MC-32a/4~40a/4 DC

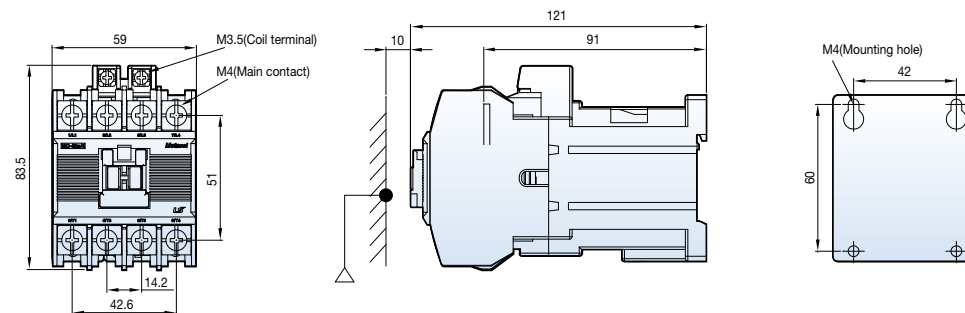

0.7kg

MC-50a/4~85a/4 AC

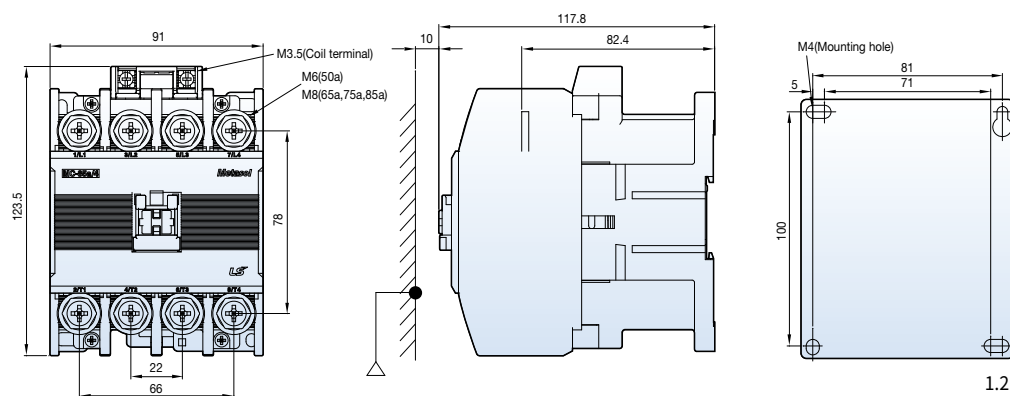

1.2kg

MC-50a/4~85a/4 DC

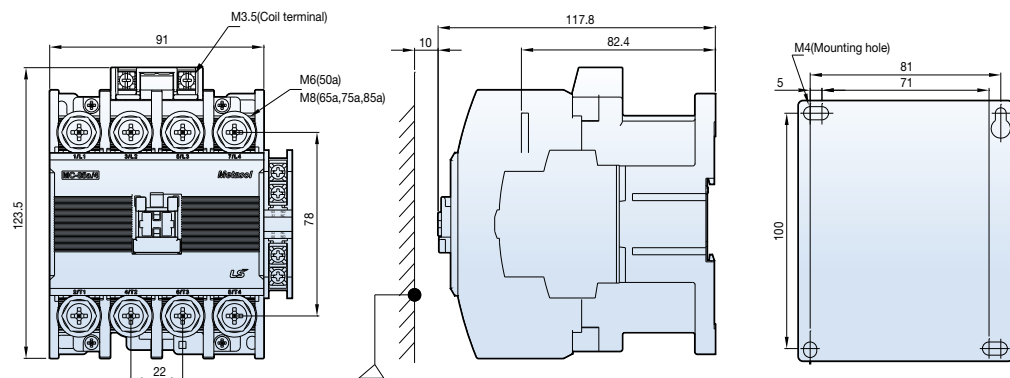

1.29kg

Note) 1b contact is being used for coil control. Therefore, if necessary, only 1a contact can be used.

Dimension

4-pole contactors MC-100a/4~800a/4

[mm]

MC-100a/4

MC-130a/4

MC-150a/4

MC-185a/4

MC-225a/4

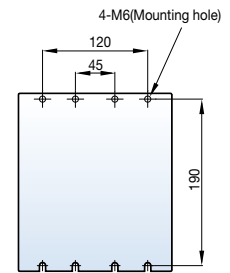
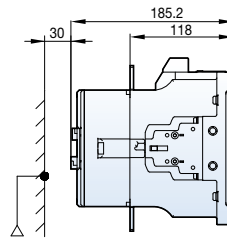
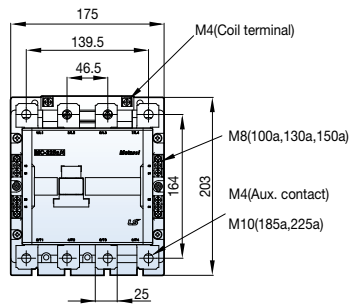

5.6kg

MC-265a/4

MC-330a/4

MC-400a/4

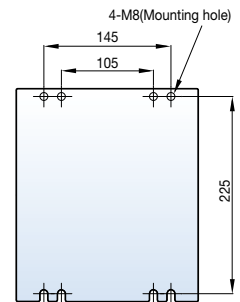
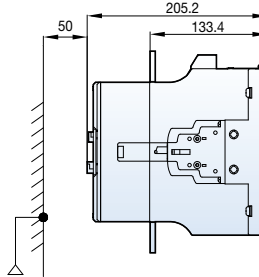
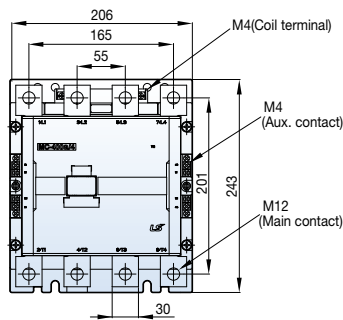

9.9kg

MC-500a/4

MC-630a/4

MC-800a/4

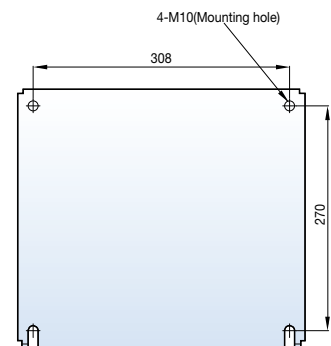
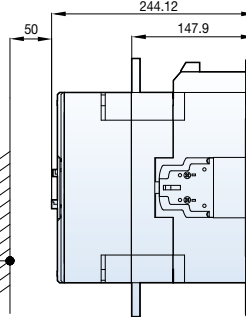
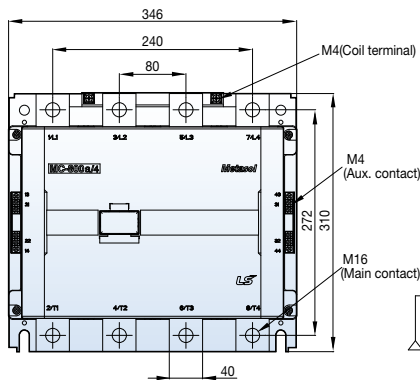

26.3kg

Enclosed motor starters, Mold enclosure

[mm]

MW-9bM~22bM

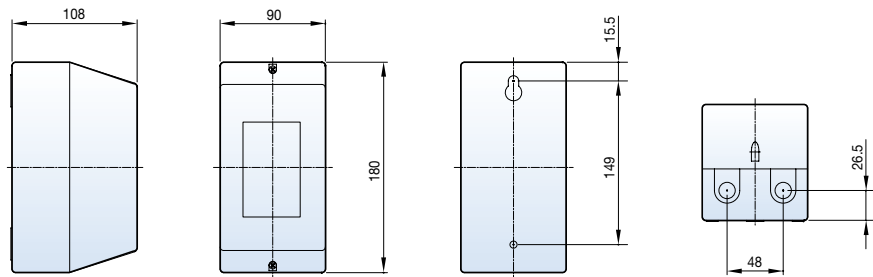

0.8kg

MW-9bMB~22bMB

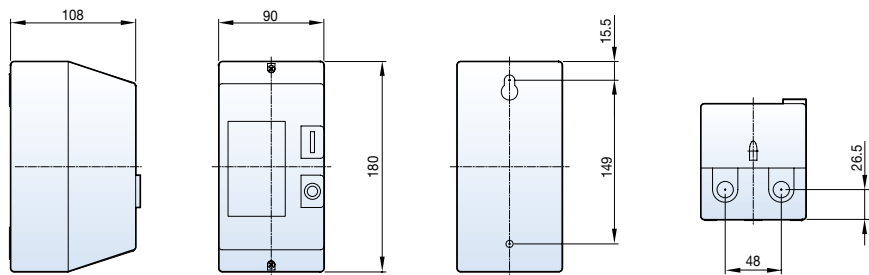

0.8kg

Circuit diagram

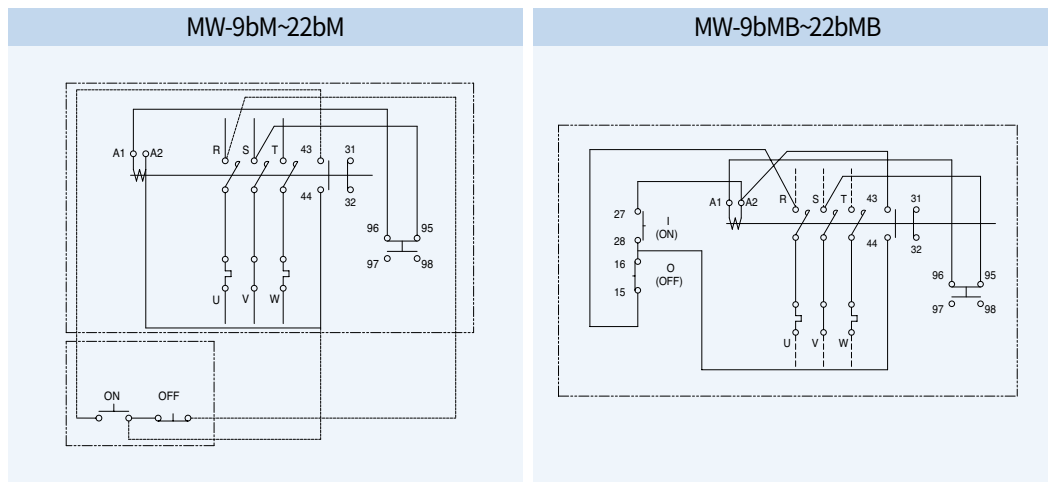

Dimension

Enclosed motor starters, Steel enclosure

[mm]

- MW-6a~100a
- MW-9b~22b

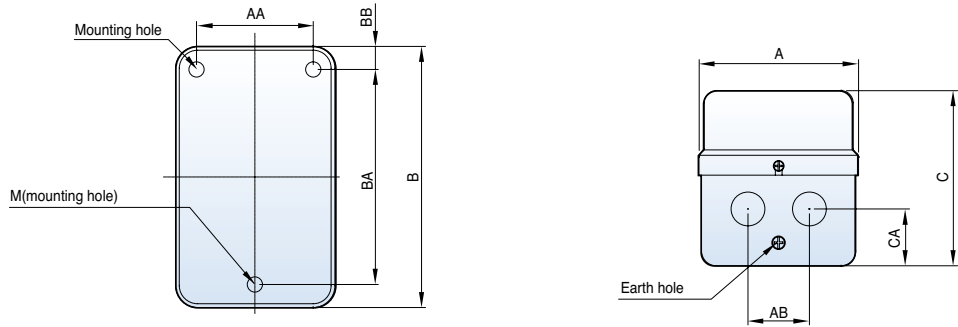

| Type | A | AA | AB | B | BA | BB | C | CA | M | N | Weight(kg) |
|-------------------|-----|-----|----|-----|-----|----|-----|----|----|-----|------------|
| MW-9b~22b, 6a~18a | 104 | 76 | 40 | 170 | 140 | 15 | 114 | 41 | M5 | Ø22 | 1.1 |
| MW-32a, 40a | 145 | 95 | 55 | 245 | 165 | 40 | 130 | 50 | M5 | Ø35 | 1.6 |
| MW-50a, 65a | 160 | 120 | 74 | 290 | 220 | 35 | 141 | 50 | M5 | Ø35 | 2.7 |
| MW-75a, 85a, 100a | 160 | 120 | 74 | 290 | 220 | 35 | 161 | 67 | M5 | Ø35 | 3.6 |

Circuit diagram

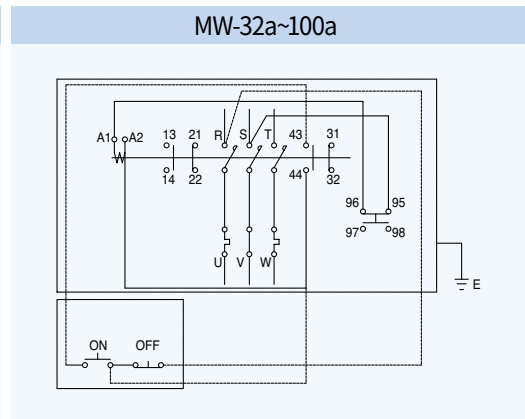
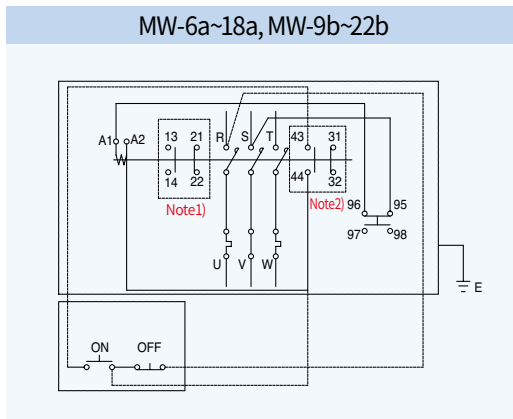

Note) 1. In case of adding the auxiliary contact unit(1NO1NC).
 2. See below for MC-6a~18a(1NO)



[mm]

MW-6aB~100aB
MW-9bB~22bB

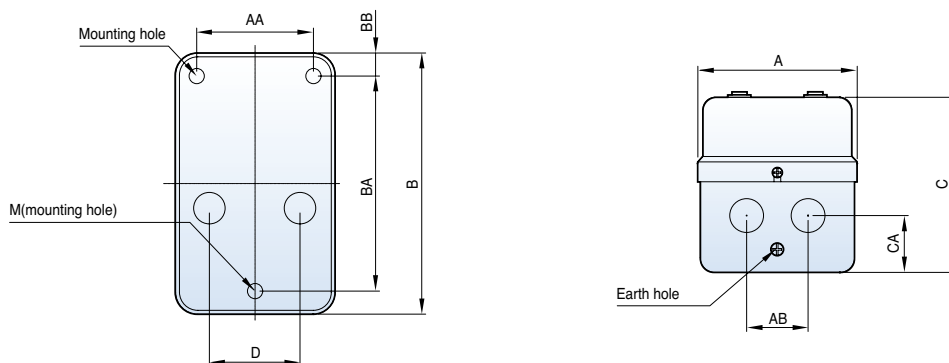

| Type | A | AA | AB | B | BA | BB | C | CA | D | M | N | Weight(kg) |
|-----------------------|-----|-----|----|-----|-----|----|-----|----|-----|----|-----|------------|
| MW-9bB~22bB, 6aB~18aB | 104 | 76 | 40 | 170 | 140 | 15 | 114 | 41 | 59 | M5 | Ø22 | 1.1 |
| MW-32aB, 40aB | 145 | 95 | 55 | 245 | 165 | 40 | 130 | 50 | 97 | M5 | Ø35 | 1.6 |
| MW-50aB, 65aB | 160 | 120 | 74 | 290 | 220 | 35 | 141 | 50 | 114 | M5 | Ø35 | 2.7 |
| MW-75aB, 85aB, 100aB | 160 | 120 | 74 | 290 | 220 | 35 | 161 | 67 | 114 | M5 | Ø35 | 3.6 |

Circuit diagram

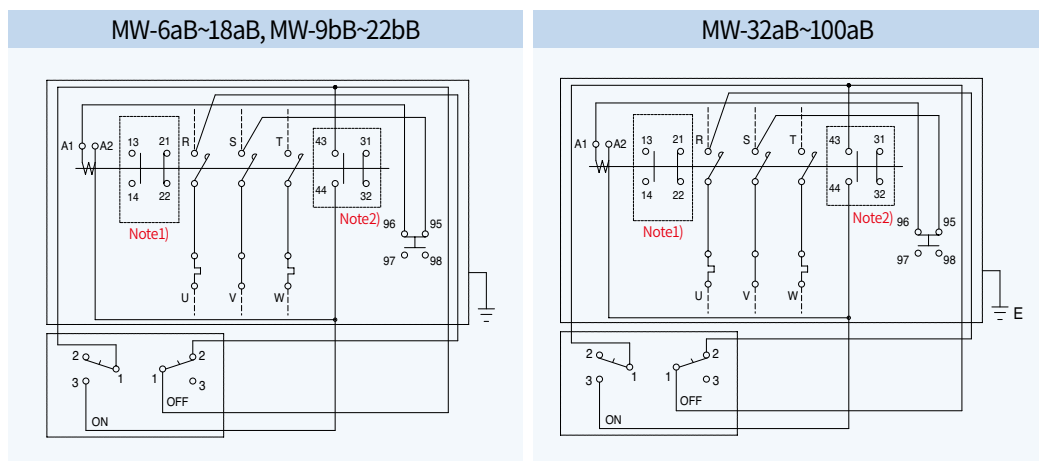

Note) 1. In case of adding the auxiliary contact unit(1NO1NC).
2. See below for MC-6a-18a(1NO)



Dimension

Capacitor contactors

MC-9b~40a with AC-9, MC-50a~65a with AC-50, MC-75a~100a with AC-75

[mm]

MC-9b~22b
with AC-9

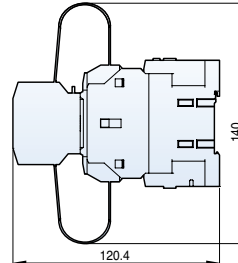
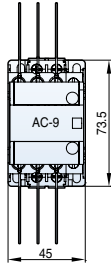

MC-32a,40a
with AC-9

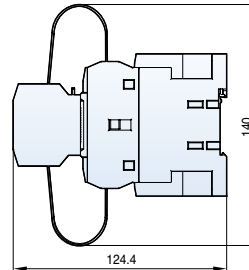
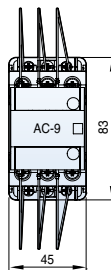

MC-50a,65a
with AC-50

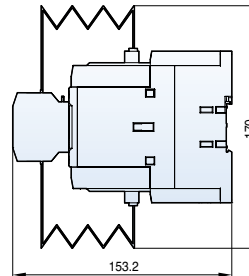
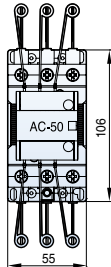

MC-75a~100a
with AC-75

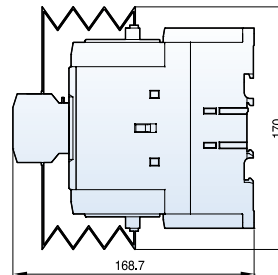
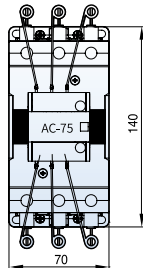

Circuit diagram

MC-9b~22b with AC-9

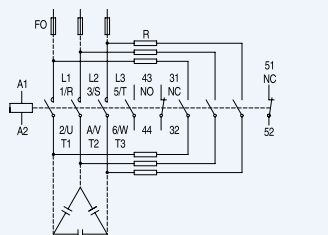

MC-32a, 40a with AC-9,
MC-50a~65a with AC-50, MC-75a~100a with AC-75

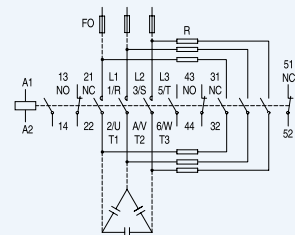

2-pole AC contactors GMC-10P2~40P2

[mm]

- GMC-10P2
 - GMC-20P2
 - GMC-25P2
 - GMC-30P2
 - GMC-35P2
 - GMC-40P2
- (TSBS Type)

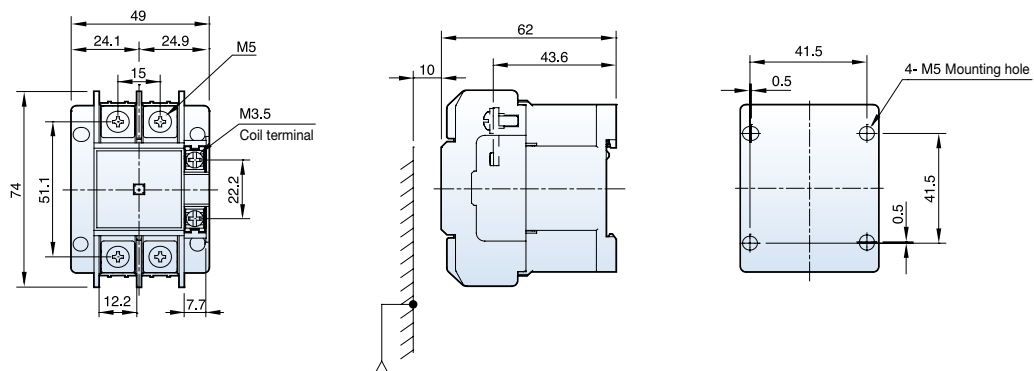

1.29kg

- GMC-10P2
 - GMC-20P2
 - GMC-25P2
 - GMC-30P2
 - GMC-35P2
 - GMC-40P2
- (TQBS Type)

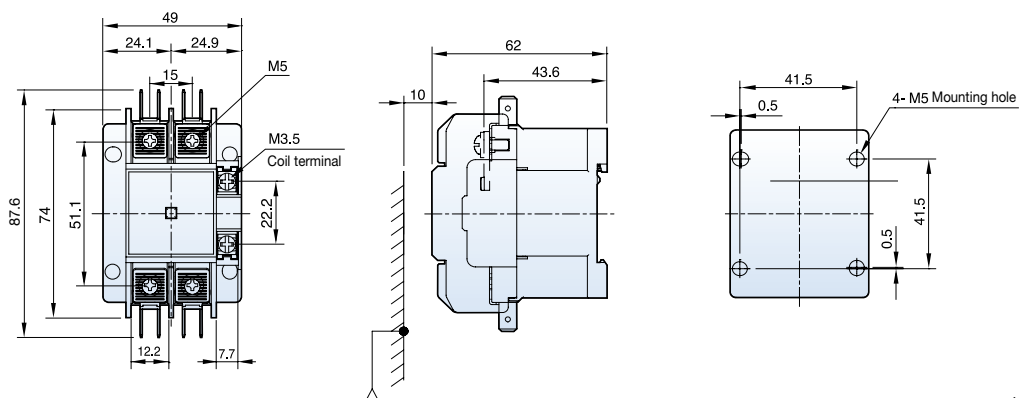

1.29kg

Composition

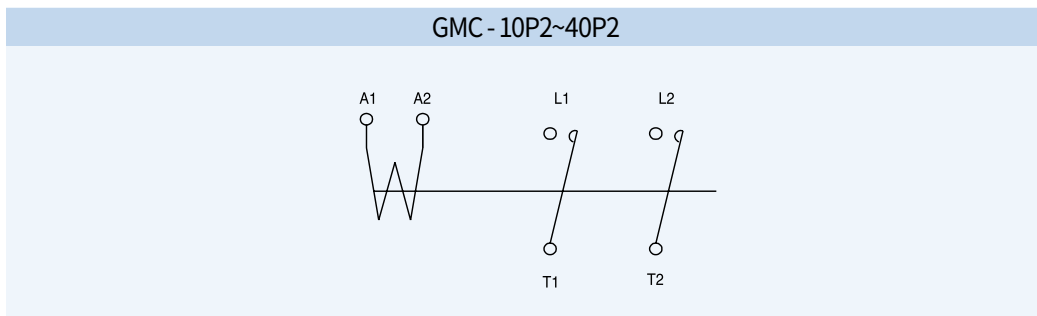

Terminal

| Type | Terminals | Screw | Wire(mm ²) | Torque(kgf·cm) | A×B×C(mm) |
|---------------|-----------|-------|------------------------|----------------|-------------|
| GMC-10P2~40P2 | Main | M5 | 1-16 | 26 | 12.2×7×8 |
| | Coil | M3.5 | 1-2.5 | 12 | 7.7×7.5×4.5 |

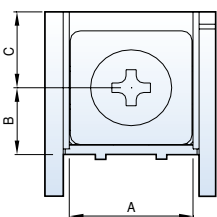

Dimension

3-pole AC Contactors GMC-20D, 25D

[mm]

- GMC-20D
- GMC-25D

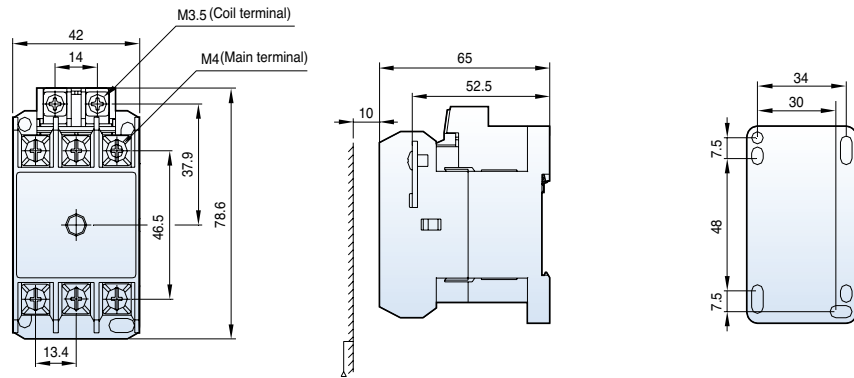

Contact arrangement

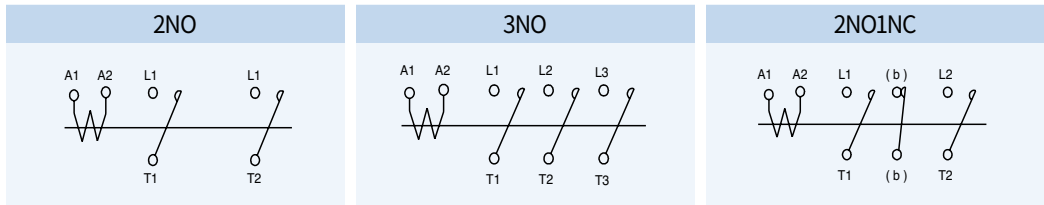

Terminal

| Type | Screw | Wire(mm ²) | Torque(kgf-cm) | A×B×C(mm) |
|-------------|-------|------------------------|----------------|------------|
| GMC-20D~25D | M4 | 1-10 | 15 | 9.4×5×85.1 |
| Coil~ | M3.5 | 1.25-2 | 12 | 8×5×4.9 |

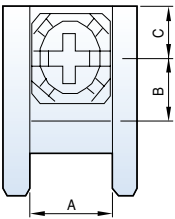

Single-pole AC Contactors MC-65aSP

MC-65aSP

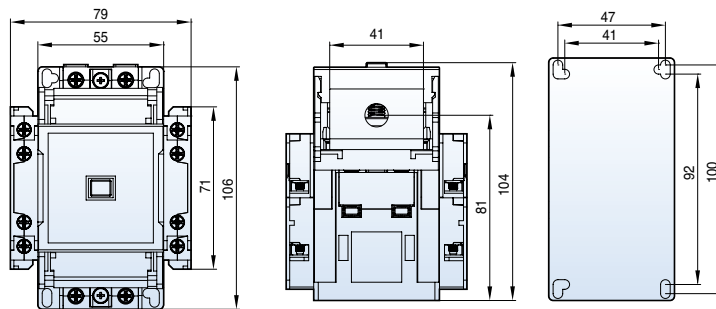

0.65kg

Composition

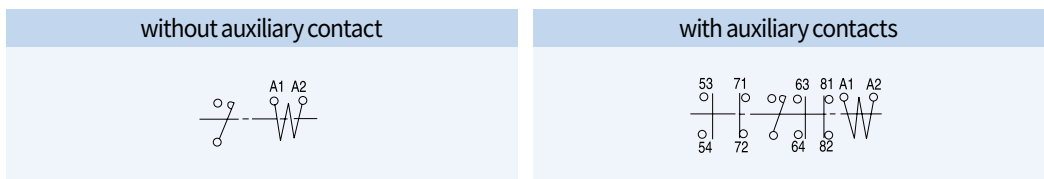

DC Contactors MD-30a, 60a, 100a

[mm]

MD-30a AC(DC)
2NO2NC

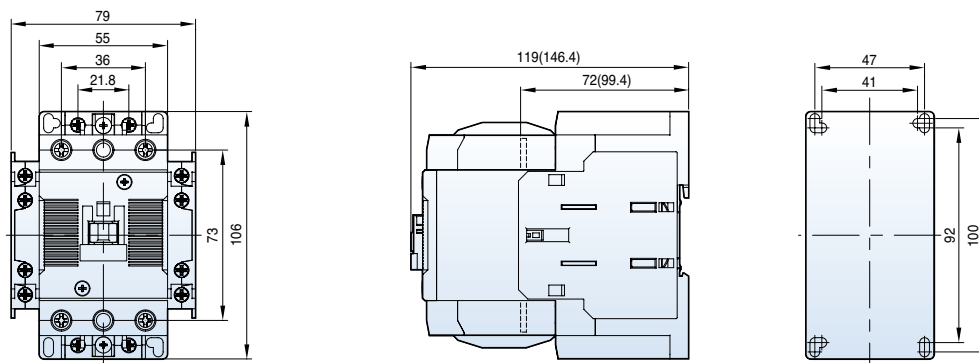

MD-60a,100a AC(DC)
2NO2NC

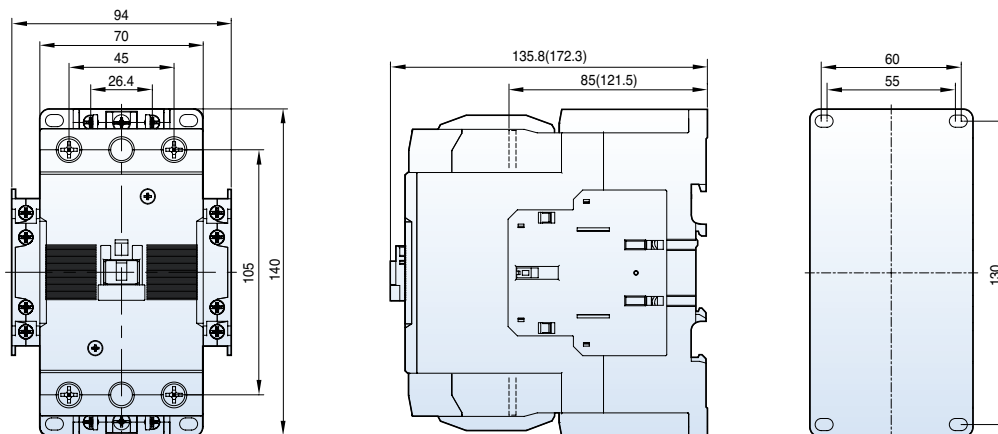

Composition

MD-30a, 60a, 100a

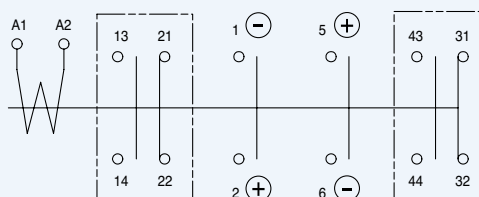

Contact arrangement

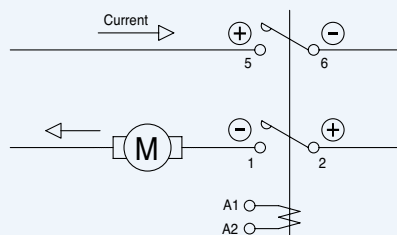

Dimension

[mm]

UA-1

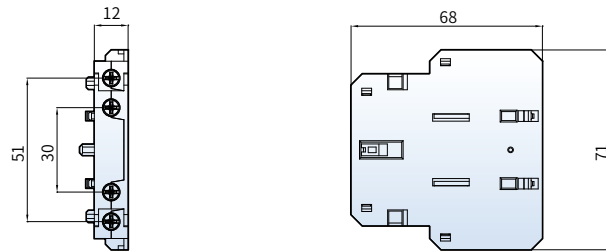

UA-2

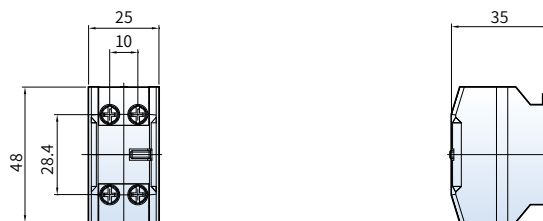

UA-4

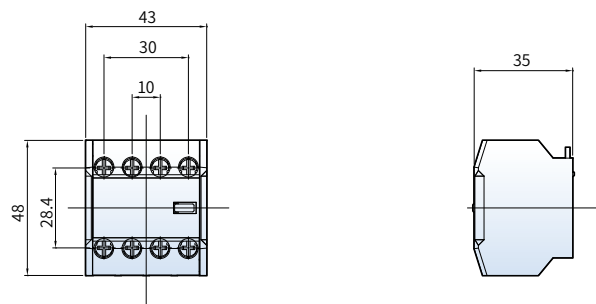

UR-02

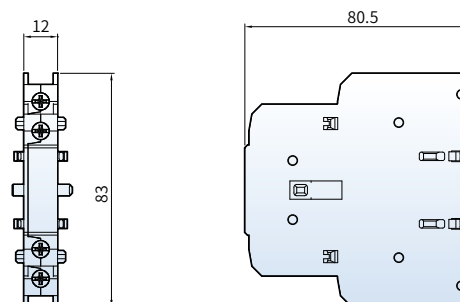

Overload relays

[mm]

MT-12



100g

MT-32

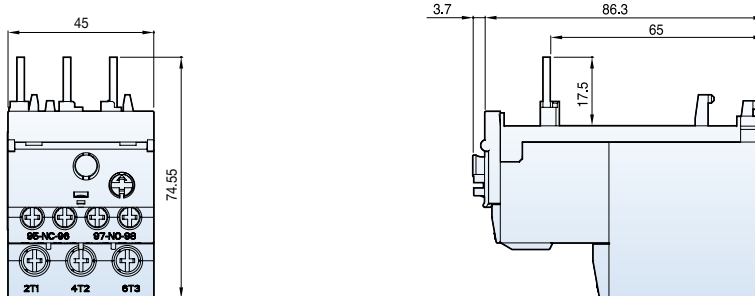

167g

MT-63

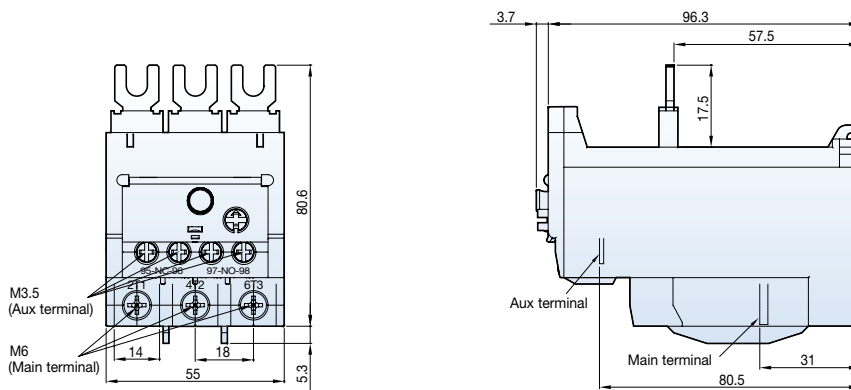

303g

MT-95

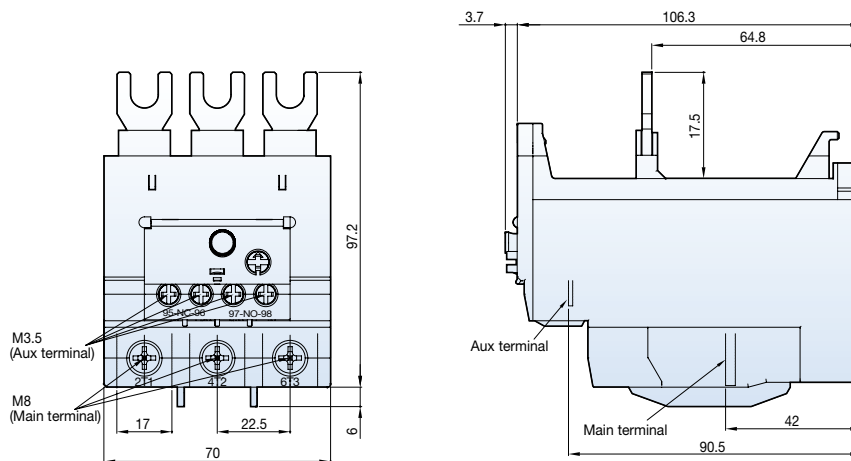

474g

Dimension

[mm]

MT-150

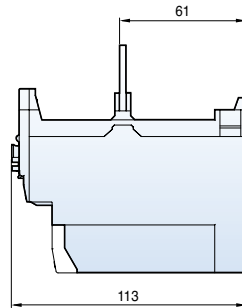
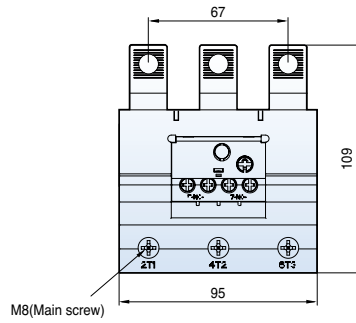

0.7kg

MT-225

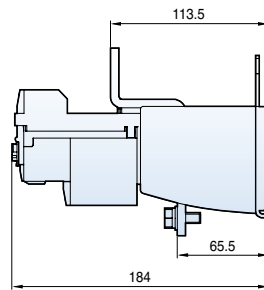
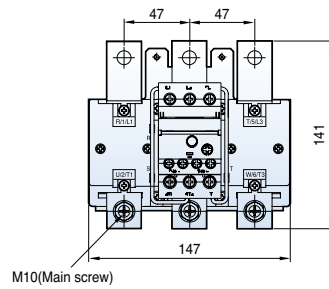

2.5kg

MT-400

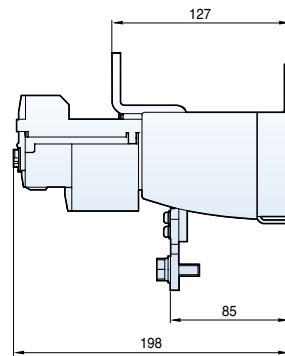
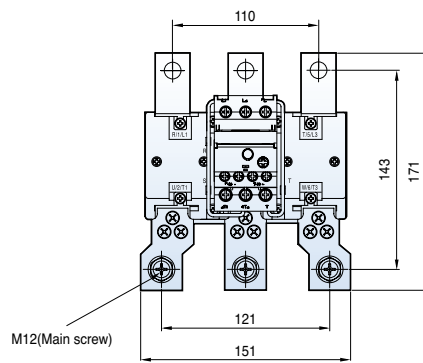

2.6kg

MT-800

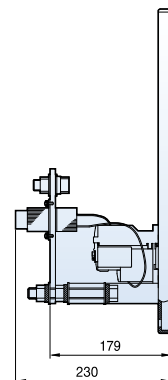
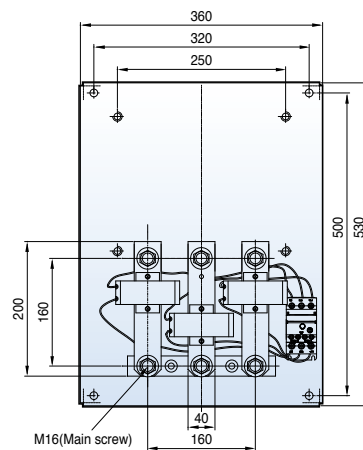

11.5kg

Overload relays

[mm]

UZ-12

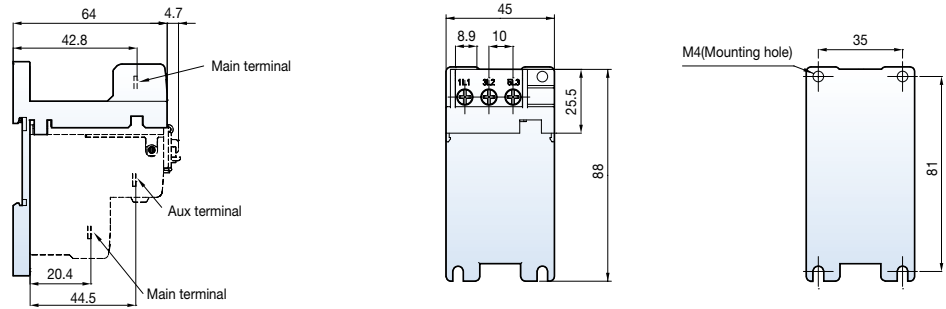

35g

UZ-32

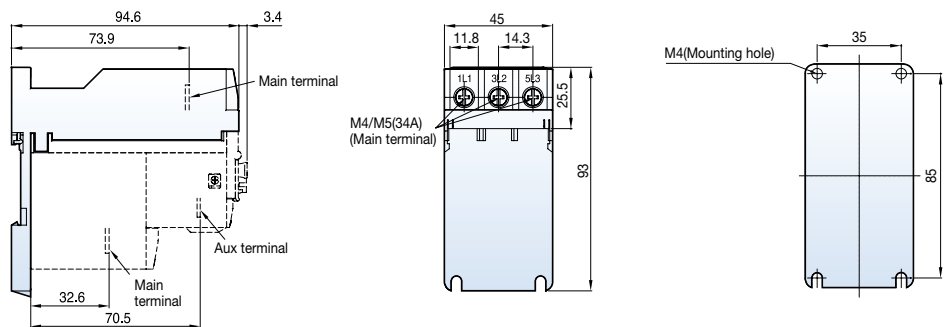

68g

UZ-63

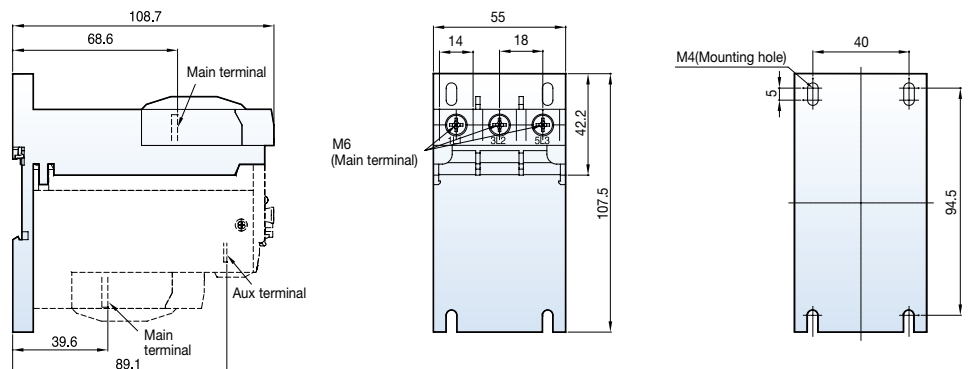

134g

Dimension (Separate mount)

[mm]

UZ-95

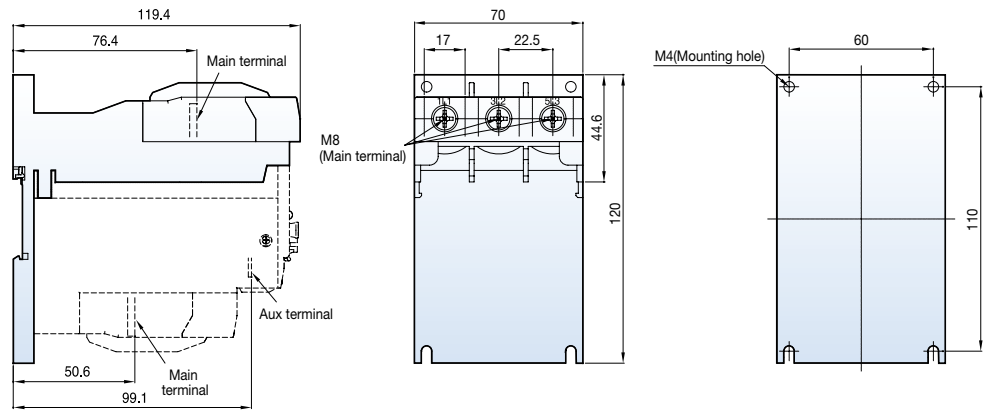

230g

UZ-150

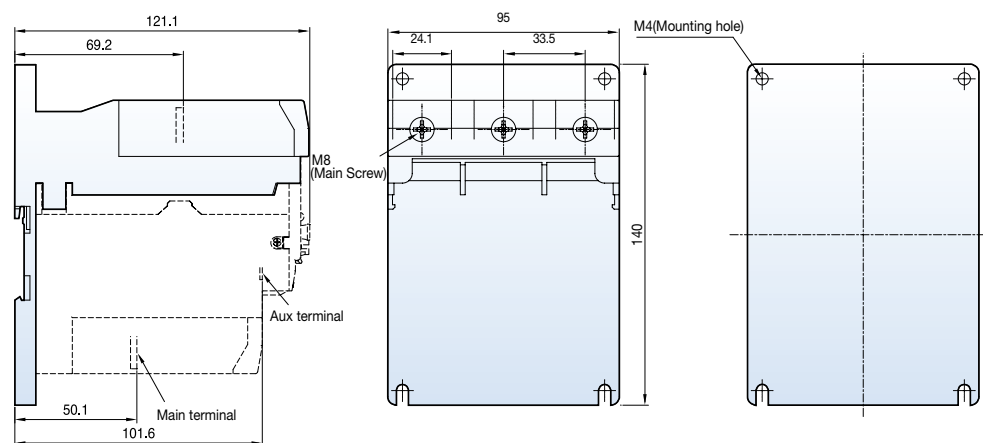

284g

Dimension

AD - 9

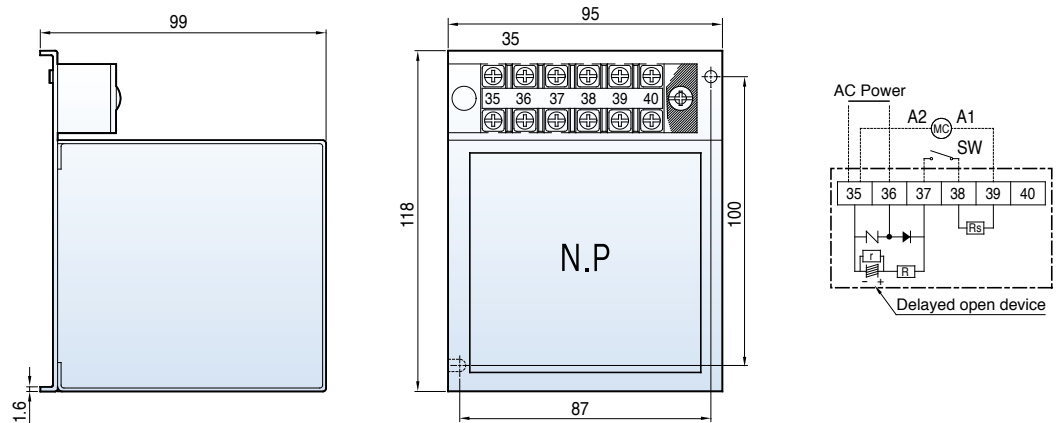

AD - 50

AD - 100

AD - 300

AD - 600

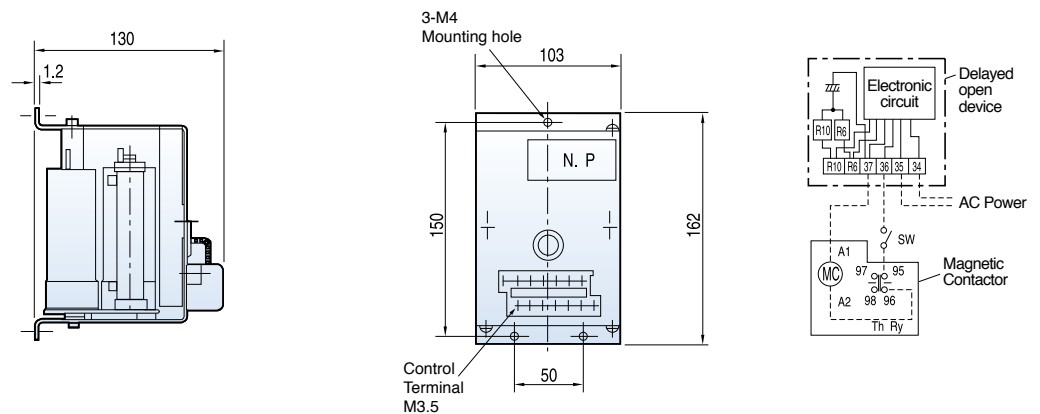

0.5kg

Control circuit diagram

AD - 9

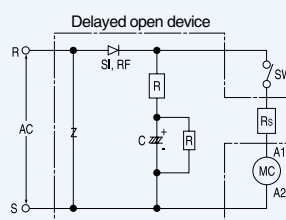

SI, RF : Rectifier
C : Condenser
Rs : Resistance in series

AD - 50~600

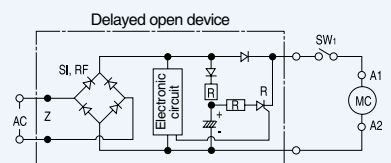

SI, RF : Rectifier
C : Condenser
Rs : Resistance in series

Electronic timer unit

ON delay timer

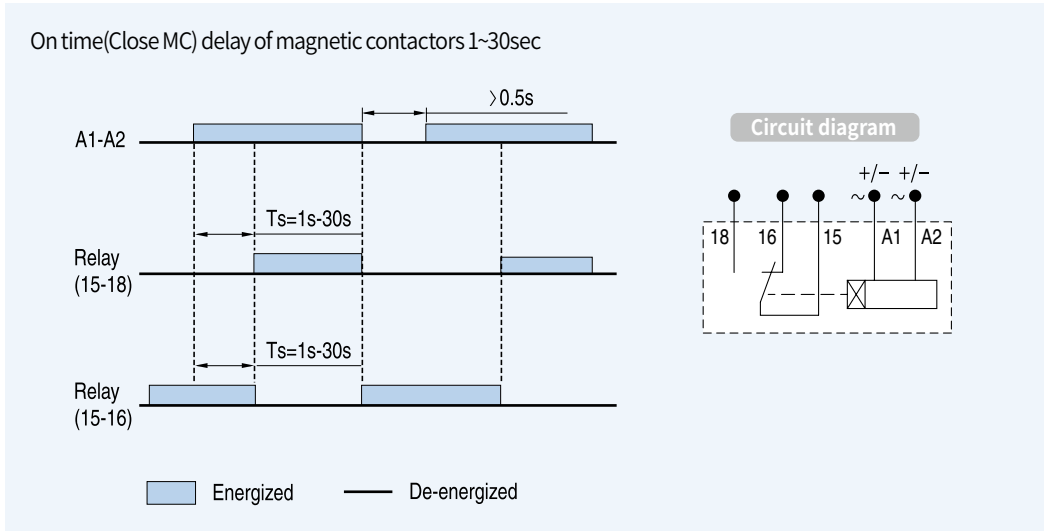

OFF delay timer

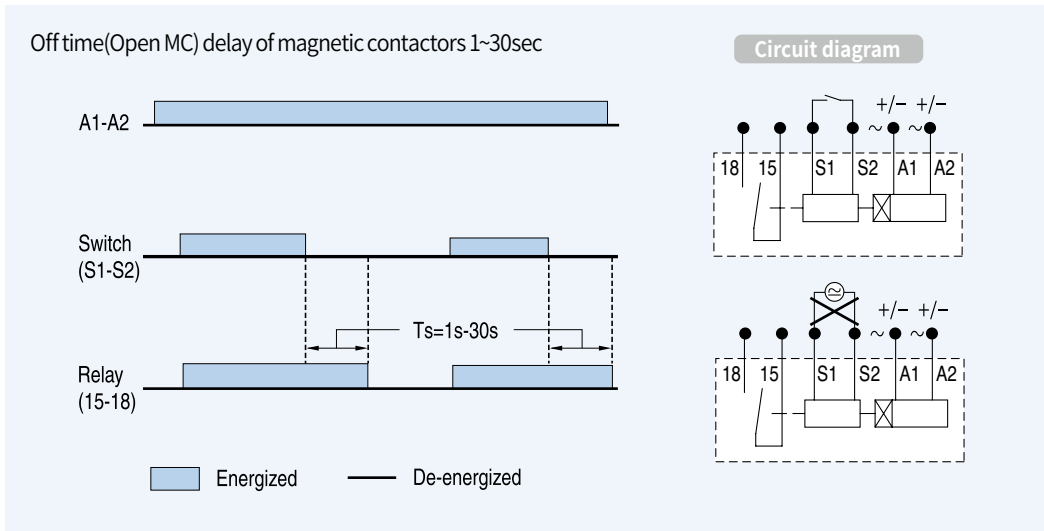

Dimension

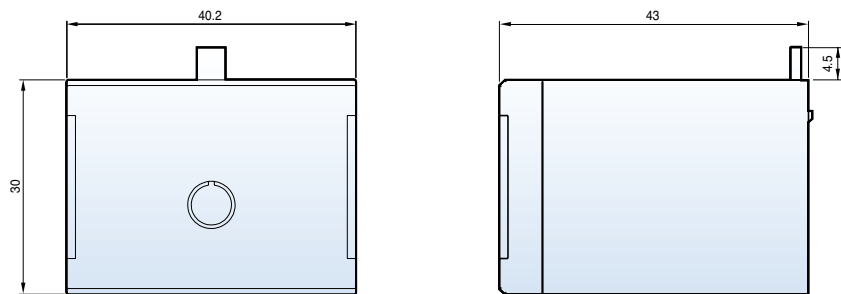

Contactors

MC-6a~18a

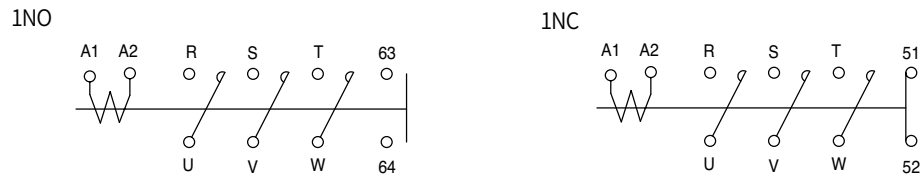

MC-9b~22b

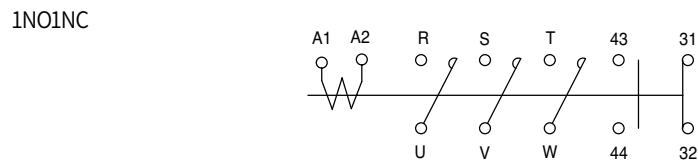

MC-32a~2650a

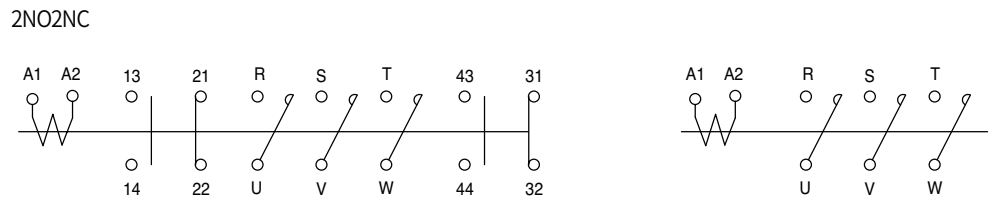

Motor starters

MS-6a~150a

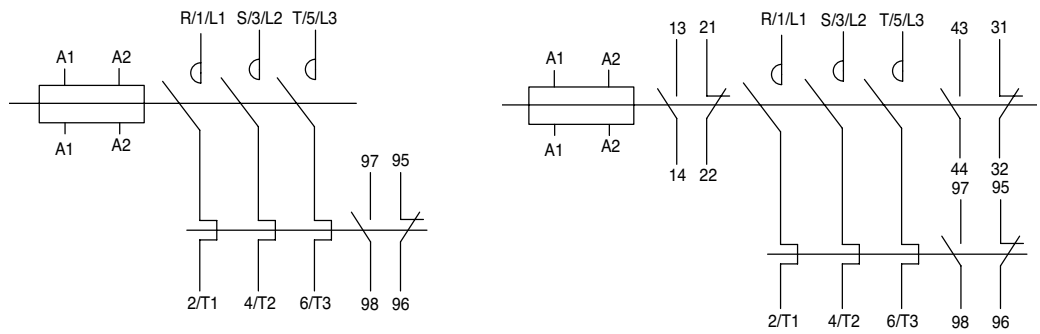

MS-185a~800a

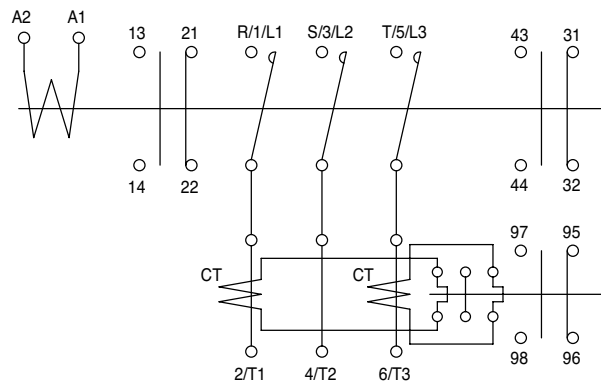

Contact arrangement

Reversing contactors

MC-6aR~150aR

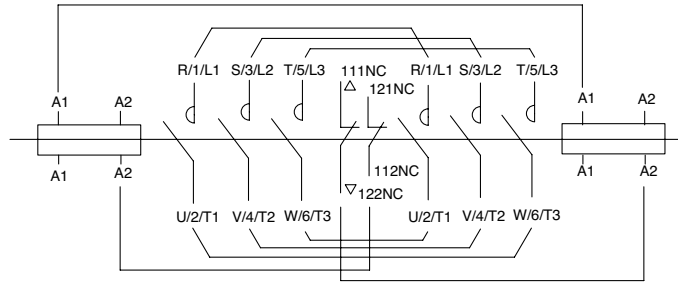

MC-185aR~800aR

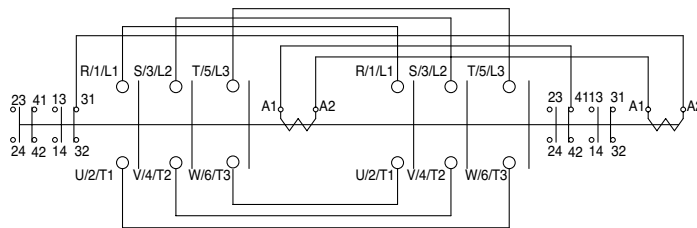

MS-6aR~150aR

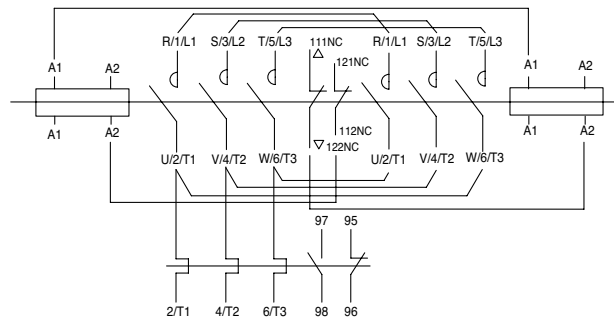

MS-185aR~400aR

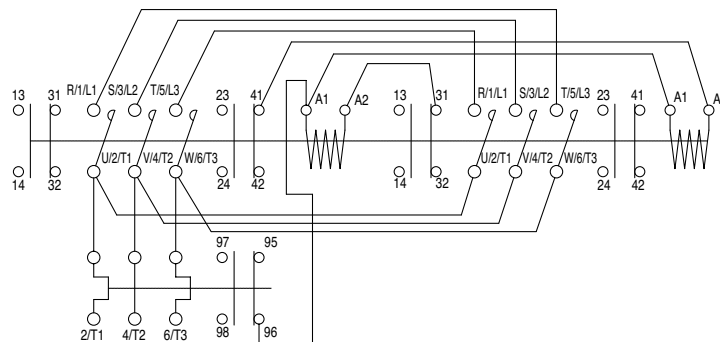

Meta-MEC and Metasol MC comparison table

Metasol MS

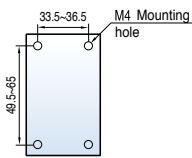
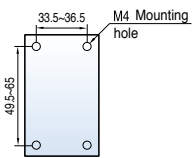
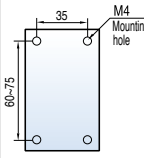
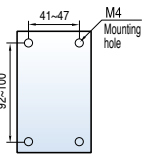
| | | Type | MC-6a | MC-9a | MC-12a | MC-18a | MC-9b | MC-12b | MC-18b | MC-22b | MC-32a | MC-40a | MC-50a | MC-65a | |
|-----------------------|------------------|-----------------------|---|-------------|--------------|--------------|--|--------------|--------------|--------------|---|--------------|---|-------------|---------------|
| Manufactured products | Metasol MC | Current and power AC3 | 200~240V | 2.2kW 9A | 2.5kW 11A | 3.5kW 13A | 4.5kW 18A | 2.5kW 11A | 3.5kW 13A | 4.5kW 18A | 5.5kW 22A | 7.5kW 32A | 11kW 40A | 15kW 55A | 18.5kW 65A |
| | | | 380~440V | 3kW 7A | 4kW 9A | 5.5kW 12A | 7.5kW 18A | 4kW 9A | 5.5kW 12A | 7.5kW 18A | 11kW 22A | 15kW 32A | 18.5kW 40A | 22kW 50A | 30kW 65A |
| | | 500~550V | 3kW 6A | 4kW 7A | 7.5kW 12A | 7.5kW 13A | 4kW 7A | 7.5kW 12A | 7.5kW 13A | 15kW 20A | 18.5kW 28A | 22kW 32A | 30kW 43A | 33kW 60A | |
| | | | Auxiliary (Standard) | 1NO or 1NC | | | | 1NO1NC | | | | - | | - | |
| | Mounting size | |  | | | |  | | | |  | |  | | |
| | Weight (kg) | | 0.33 | | | | 0.34 | | | | 0.4 | | 0.9 | | |
| | Demension(W×H×D) | | 45×73.5×80.4 | | | | 45×73.5×87.4 | | | | 45×83×90 | | 55×106×119 | | |

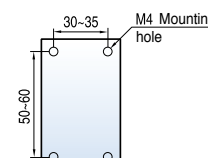
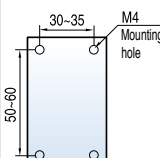
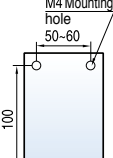
| | | Type | - | GMC-9 | GMC-12 | GMC-18 | GMC-22 | GMC-32 | GMC-40 | GMC-50 | GMC-65 | | |
|-----------------------|----------------------------|-----------------------|----------------------|--------------|--------------|--------------|--|--------------|---|---------------|---|---------------|--------------|
| Discontinued products | Meta-MEC MC | Current and power AC3 | 200~220V | - | 2.5kW 11A | 3.5kW 13A | 4.5kW 18A | 5.5kW 22A | 7.5kW 32A | 11kW 40A | 15kW 55A | 18.5kW 65A | |
| | | | 380~440V | - | 4kW 9A | 5.5kW 12A | 7.5kW 18A | 11kW 22A | 15kW 32A | 18.5kW 40A | 22kW 50A | 30kW 65A | |
| | | 500~550V | 4kW 7A | 7.5kW 12A | 7.5kW 13A | 15kW 22A | 18.5kW 28A | 22kW 32A | 30kW 43A | 33kW 60A | | | |
| | | | Auxiliary (Standard) | - | 1NO1NC | 1NO1NC | 1NO1NC | 1NO1NC | 2NO2NC | 2NO2NC | 2NO2NC | 2NO2NC | |
| | Mounting size | | - | | | |  | |  | |  | | |
| | Weight (kg) | | - | | | | 0.33 | | 0.37 | | 0.45 | | 1 |
| | Demension(W×H×D) | | - | | | | 44×80×86.8 | | | | 68×82×94.6 | | 94×122×115.7 |
| | Compatibility with Metasol | | - | | | | ○ | | | | ▲ | | ▲ |

Note) Marks of compatibility

○: can be compatible

▲: compatible when applied the bracket

×: can't be compatible(have to use bracket)

Meta-MEC and Metasol MC comparison table

| | | Type | MC-75a | MC-85a | MC-100a | MC-130a | MC-150a | MC-185a | MC-225a | MC-265a | MC-330a | MC-400a | MC-500a | MC-630a | MC-800a | |
|-----------------------|------------------|-----------------------|----------------------|--------------|-------------|--------------|--------------|---------------|---------------|---------------|---------------|---------------|---------------|---------------|---------------|---------------|
| Manufactured products | Metasol MC | Current and power AC3 | 200~240V | 22 kW 75A | 25kW 85A | 30kW 105A | 37kW 130A | 45kW 150A | 55kW 185A | 75kW 225A | 80kW 265A | 90kW 330A | 125kW 400A | 147kW 500A | 190kW 630A | 220kW 800A |
| | | | 380~440V | 37 kW 75A | 45kW 85A | 55kW 105A | 60kW 130A | 75kW 150A | 90kW 185A | 132kW 225A | 147kW 265A | 160kW 330A | 200kW 400A | 265kW 500A | 330kW 630A | 440kW 800A |
| | | 500~550V | 37 kW 64A | 45 kW 75A | 55kW 85A | 60kW 90A | 70kW 100A | 110kW 180A | 132kW 200A | 147kW 225A | 160kW 280A | 225kW 350A | 265kW 400A | 330kW 500A | 500kW 630A | 720A |
| | | | Auxiliary (Standard) | - | | | - | | 2NO2NC | | 2NO2NC | | | 2NO2NC | | |
| | Mounting size | | | | | | | | | | | | | | | |
| | Weight (kg) | 1.6 | | | | 2.4 | | 5.4 | | 9.2 | | | 22.4 | | | |
| | Demension(W×H×D) | 70×140×135.8 | | | | 95×158×130.3 | | 138×203×185.1 | | 163×243×204.4 | | | 285×312×245.3 | | | |

| | | Type | GMC-75 | GMC-85 | GMC-100 | GMC-125 | GMC-150 | GMC-180 | GMC-220 | - | GMC-300 | GMC-400 | - | GMC-600 | GMC-800 | | |
|----------------------------|------------------|-----------------------|----------------------|-----------------|-------------|--------------|--------------|---------------|---------------|---------------|---------------|---------------|---------------|---------------|---------------|---------------|--|
| Discontinued products | Meta-MEC MC | Current and power AC3 | 200~220V | 22kW 75A | 25kW 85A | 30kW 105A | 37kW 125A | 45kW 150A | 55kW 180A | 75kW 250A | - | 90kW 300A | 125kW 400A | - | 190kW 630A | 220kW 800A | |
| | | | 380~440V | 37kW 75A | 45kW 85A | 55kW 105A | 60kW 120A | 75kW 150A | 90kW 180A | 132kW 250A | - | 160kW 300A | 200kW 400A | - | 330kW 630A | 440kW 800A | |
| | | 500~550V | 37kW 64A | 45kW 75A | 55kW 85A | 60kW 90A | 90kW 140A | 110kW 180A | 132kW 200A | - | 160kW 250A | 225kW 350A | - | 330kW 500A | 500kW 720A | | |
| | | | Auxiliary (Standard) | 2NO2NC | 2NO2NC | 2NO2b | 2NO2NC | 2NO2NC | 2NO2NC | 2NO2NC | - | 2NO2NC | 2NO2NC | - | 2NO2NC | 2NO2NC | |
| | Mounting size | | | | | | | | | | | | | | | | |
| | Weight (kg) | 1 | | 2.9 | | 3.4 | | 5.4 | | - | | 9.2 | | - | | 22 | |
| | Demension(W×H×D) | 94×122×115.7 | | 100×157.4×146.5 | | 120×166×157 | | 138×203×181 | | - | | 163×243×198 | | - | | 285×290×242 | |
| Compatibility with Metasol | ▲ | | × | | × | | ○ | | - | | ○ | | - | | ○ | | |

Note) Marks of compatibility
 ○: can be compatible
 ▲: compatible when applied the bracket
 ×: can't be compatible(have to use bracket)

Meta-MEC and Metasol MS comparison table

Metasol MS

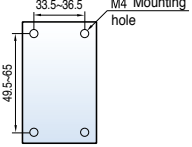
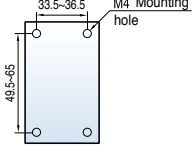
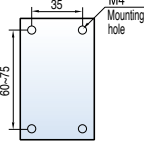
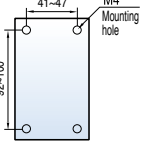
| | | Type | MS-6a | MS-9a | MS-12a | MS-18a | MS-9b | MS-12b | MS-18b | MS-22b | MS-32a | MS-40a | MS-50a | MS-65a | |
|-----------------------|------------------|-----------------------|---|-------------|--------------|--------------|--|--------------|--------------|--------------|---|--------------|---|-------------|---------------|
| Manufactured products | Metasol MC | Current and power AC3 | 200~240V | 2.2kW 9A | 2.5kW 11A | 3.5kW 13A | 4.5kW 18A | 2.5kW 11A | 3.5kW 13A | 4.5kW 18A | 5.5kW 22A | 7.5kW 32A | 11kW 40A | 15kW 55A | 18.5kW 65A |
| | | | 380~440V | 3kW 7A | 4kW 9A | 5.5kW 12A | 7.5kW 18A | 4kW 9A | 5.5kW 12A | 7.5kW 18A | 11kW 22A | 15kW 32A | 18.5kW 40A | 22kW 50A | 30kW 65A |
| | | 500~550V | 3kW 6A | 4kW 7A | 7.5kW 12A | 7.5kW 13A | 4kW 7A | 7.5kW 12A | 7.5kW 13A | 15kW 20A | 18.5kW 28A | 22kW 32A | 30kW 43A | 33kW 60A | |
| | | | Auxiliary (Standard) | 1NO or 1NC | | | | 1NO1NC | | | | - | | - | |
| | Mounting size | |  | | | |  | | | |  | |  | | |
| | Weight (kg) | | 0.5 | | | | 0.5 | | | | 0.7 | | 1.5 | | |
| | Demension(W×H×D) | | 45×124×80.4 | | | | 45×129.9×87.4 | | | | 45×139.4×90 | | 55×163.8×119 | | |

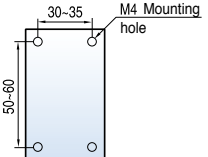
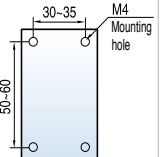
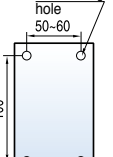
| | | Type | - | GMS-9 | GMS-12 | GMS-18 | GMS-22 | GMS-32 | GMS-40 | GMS-50 | GMS-65 | | |
|-----------------------|----------------------------|-----------------------|----------------------|-----------|--------------|--------------|--|---------------|---|---------------|---|---------------|----------------|
| Discontinued products | Meta-MEC MC | Current and power AC3 | 200~220V | - | 2.5kW 11A | 3.5kW 13A | 4.5kW 18A | 5.5kW 22A | 7.5kW 32A | 11kW 40A | 15kW 55A | 18.5kW 65A | |
| | | | 380~440V | - | 4kW 9A | 5.5kW 12A | 7.5kW 18A | 11kW 22A | 15kW 32A | 18.5kW 40A | 22kW 50A | 30kW 65A | |
| | | 500~550V | - | 4kW 7A | 7.5kW 12A | 7.5kW 13A | 15kW 22A | 18.5kW 28A | 22kW 32A | 30kW 43A | 33kW 60A | | |
| | | | Auxiliary (Standard) | - | 1NO1NC | 1NO1NC | 1NO1NC | 1NO1NC | 2NO2NC | 2NO2NC | 2NO2NC | 2NO2NC | |
| | Mounting size | | - | | | |  | |  | |  | | |
| | Weight (kg) | | - | | | | 0.46 | | 0.5 | | 0.45 | | 1.12 |
| | Demension(W×H×D) | | - | | | | 44×128.9×86.8 | | | | 68×136.5×94.6 | | 94×181.5×115.7 |
| | Compatibility with Metasol | | - | | | | ○ | | | | × | | × |



Note) Marks of compatibility

○: can be compatible

×: can't be compatible(have to use bracket)

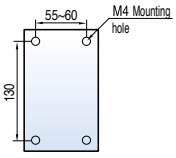
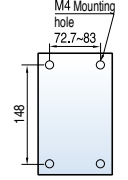
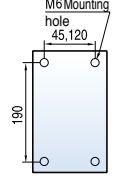
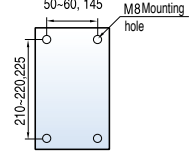
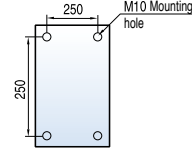
Meta-MEC and Metasol MS comparison table

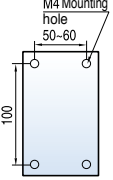
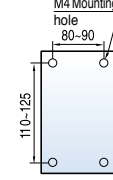
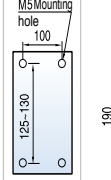
| | | Type | MS-75a | MS-85a | MS-100a | MS-130a | MS-150a | MS-185a | MS-225a | MS-265a | MS-330a | MS-400a | MS-500a | MS-630a | MS-800a | |
|-----------------------|----------------------|-----------------------|---|--------------|-------------|---|--------------|---|---------------|--|---------------|---------------|---|---------------|---------------|---------------|
| Manufactured products | Metasol MC | Current and power AC3 | 200~240V | 22 kW 75A | 25kW 85A | 30kW 105A | 37kW 130A | 45kW 150A | 55kW 185A | 75kW 225A | 80kW 265A | 90kW 330A | 125kW 400A | 147kW 500A | 190kW 630A | 220kW 800 |
| | | | 380~440V | 37 kW 75A | 45kW 85A | 55kW 105A | 60kW 130A | 75kW 150A | 90kW 185A | 132kW 225A | 147kW 265A | 160kW 330A | 200kW 400A | 265kW 500A | 330kW 630A | 440kW 800A |
| | | 500~550V | 37 kW 64A | 45 kW 75A | 55kW 85A | 60kW 90A | 70kW 100A | 110kW 180A | 132kW 200A | 147kW 225A | 160kW 280A | 225kW 350A | 265kW 400A | 330kW 500A | 500kW 500A | 720A 720A |
| | Auxiliary (Standard) | | - | | | - | | 2NO2NC | | 2NO2NC | | | 2NO2NC | | | |
| | Mounting size | |  | | |  | |  | |  | | |  | | | |
| | Weight (kg) | | 2.4 | | | 3 | | 7.9 | | 11.8 | | | 28 | | | |
| | Demension(W×H×D) | | 70×211.4×135.8 | | | 95×236.2×130.3 | | 138×306.5×185.1 | | 163×380×204.4 | | | 360×530×245.3 | | | |

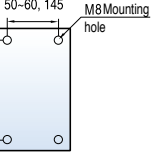
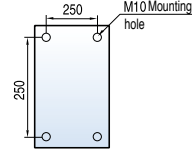
| | | Type | GMC-75 | GMC-85 | GMC-100 | GMC-125 | GMC-150 | GMC-180 | GMC-220 | - | GMC-300 | GMC-400 | - | GMC-600 | GMC-800 | | |
|----------------------------|----------------------|-----------------------|---|-------------|---|--------------|---|---------------|---|---------------|---|---------------|---------------|---|---------------|---------------|--|
| Discontinued products | Meta-MEC MC | Current and power AC3 | 200~220V | 22kW 75A | 25kW 85A | 30kW 105A | 37kW 125A | 45kW 150A | 55kW 180A | 75kW 250A | - | 90kW 300A | 125kW 400A | - | 190kW 630A | 220kW 800A | |
| | | | 380~440V | 37kW 75A | 45kW 85A | 55kW 105A | 60kW 120A | 75kW 150A | 90kW 180A | 132kW 250A | - | 160kW 300A | 200kW 400A | - | 330kW 630A | 440kW 800A | |
| | | 500~550V | 37kW 64A | 45kW 75A | 55kW 85A | 60kW 90A | 90kW 140A | 110kW 180A | 132kW 200A | - | 160kW 250A | 225kW 350A | - | 330kW 500A | 500kW 720A | | |
| | Auxiliary (Standard) | | 2NO2NC | 2NO2NC | 2NO2NC | 2NO2NC | 2NO2NC | 2NO2NC | 2NO2NC | - | 2NO2NC | 2NO2NC | - | 2NO2NC | 2NO2NC | | |
| | Mounting size | |  | |  | |  | |  | |  | | |  | | | |
| | Weight (kg) | | 1.12 | | 3.4 | | 4 | | 7.9 | | - | | | 11.8 | | - | |
| | Demension(W×H×D) | | 94×181.5×115.7 | | 114×231.4×146.5 | | 120×206.4×157 | | 138×306.54×181 | | - | | | 163×380×198 | | - | |
| Compatibility with Metasol | | × | | | × | | ○ | | - | | | ○ | | - | | | |

Note) Marks of compatibility
 ○: can be compatible
 ×: can't be compatible(have to use bracket)

Meta-MEC and Metasol relays comparison table

Metasol MS

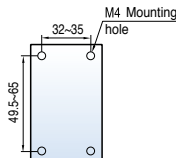
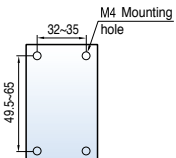
| | | Type | MR-4 | MR-6 | MR-8 | |
|-----------------------|-------------------|-------------------|---|---------------------------------------|--|---|
| Manufactured products | Metasol MR | Auxiliary (kW) | 4NO, 3NO1NC, 2NO2NC 1NO3NC, 4NC | 6NO, 5NO1NC, 4NO2NC 3NO3NC, 2NO4NC | 8NO, 7NO1NC, 6NO2NC 5NO3NC, 4NO4NC | |
| | | Rated current (A) | 120 V | 6 | 6 | 6 |
| | AC15 | 240 V | 3 | 3 | 3 | |
| | Mounting size | |  | |  | |
| | Dimension (W×H×D) | | 45×73.5×79(96.6) | 45×73.5×109.6(127.2) | 45×73.5×109.6(127.2) | |
| | Weight (kg) | | 0.284 | 0.315 | 0.339 | |

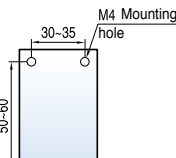
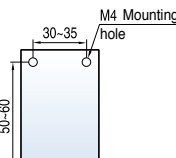
| | | Type | GMR-4(D) | GMR-6(D) | GMR-8(D) | |
|-----------------------|-------------------|-------------------|---|---------------------------------------|--|---|
| Discontinued products | GMR | Auxiliary (kW) | 4NO, 3NO1NC, 2NO2NC 1NO3NC, 4NC | 6NO, 5NO1NC, 4NO2NC 3NO3NC, 2NO4NC | 8NO, 7NO1NC, 6NO2NC 5NO3NC, 4NO4NC | |
| | | Rated current (A) | AC110V | 6 | 6 | 6 |
| | AC11 | AC220V | 5 | 5 | 5 | |
| | Mounting size | |  | |  | |
| | Dimension (W×H×D) | | 44×80×86.8(113.2) | 44×80×118.6(145) | 44×80×118.6(145) | |
| | Weight (kg) | | 0.34(0.56) | 0.37(0.59) | 0.39(0.61) | |

Meta-MEC and Metasol TOR comparison table





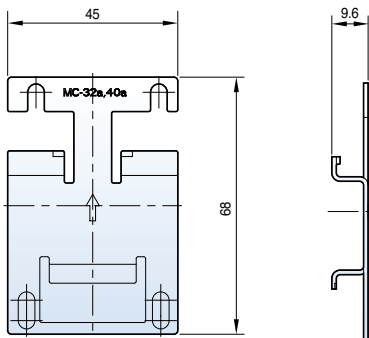
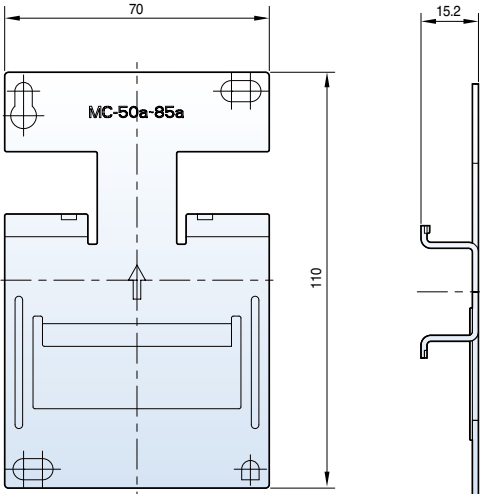

| Manufactured products | | Discontinued products | |
|-----------------------|--|-----------------------|--|
| MT | | GTH (K) | |
| MT-12 | 0.14(0.1~0.16), 0.21(0.16~0.25), 0.33(0.25~0.4), 0.52(0.4~0.63), 0.82(0.63~1), 1.3(1~1.6), 2.1(1.6~2.5), 3.3(2.5~4), 5(4~6), 6.5(5~8), 7.5(6~9), 8.5(7~10), 11(9~13), 15(12~18), 19(16~22) | GTH(K)-22 | 0.14(0.1~0.16), 0.21(0.16~0.25), 0.33(0.25~0.4), 0.52(0.4~0.63), 0.82(0.63~1), 1.3(1~1.6), 2.1(1.6~2.5), 3.3(2.5~4), 5(4~6), 6.5(5~8), 7.5(6~9), 8.5(7~10), 11(9~13), 15(12~18), 19(16~22) |
| MT-32 | 0.14(0.1~0.16), 0.21(0.16~0.25), 0.33(0.25~0.4), 0.52(0.4~0.63), 0.82(0.63~1), 5(4~6), 6.5(5~8), 7.5(6~9), 8.5(7~10), 11(9~13), 15(12~18), 19(16~22), 22(18~26), 34(28~40) | GTH(K)-40 | 5(4~6), 6.5(5~8), 7.5(6~9), 8.5(7~10), 11(9~13), 15(12~18), 19(16~22), 22(18~26), 30(24~36), 34(28~40) |
| MT-63 | 5(4~6), 6.5(5~8), 7.5(6~9), 8.5(7~10), 11(9~13), 15(12~18), 19(16~22), 22(18~26), 30(24~36), 34(28~40), 42(34~50), 54(45~65) | GTH(K)-85 | 8.5(7~10), 11(9~13), 15(12~18), 19(16~22), 22(18~26), 30(24~36), 34(28~40), 42(34~50), 55(45~65), 65(54~75), 74(63~85) |
| MT-95 | 8.5(7~10), 11(9~13), 15(12~18), 19(16~22), 22(18~26), 30(24~36), 34(28~40), 42(34~50), 54(45~65), 65(54~75), 74(63~85), 83(70~95), 90(80~100) | GTH(K)-100 | 41(34~50), 48(39~57), 56(43~65), 67(54~80), 80(65~100), 107(85~125) |
| MT-150 | 42(34~50), 55(45~65), 65(54~75), 74(63~85), 93(80~105), 113(95~130), 130(110~150) | GTH(K)-150 | 41(34~50), 48(39~57), 56(43~65), 67(54~80), 80(65~100), 107(85~125), 130(100~150) |
| MT-225 | 80(65~100), 107(85~125), 130(100~160), 153(120~185), 200(160~240) | GTH(K)-220 | 80(65~100), 107(85~125), 130(100~160), 150(120~180), 200(160~240) |
| MT-400 | 107(85~125), 130(100~160), 153(120~185), 200(160~240), 265(200~330), 350(260~400) | GTH(K)-400 | 107(85~125), 130(100~160), 150(120~180), 200(160~240), 250(200~300), 350(260~400) |
| MT-800 | 265(200~300), 350(260~400), 515(400~630), 660(520~800) | GTH(K)-600 | 250(200~300), 350(260~400), 500(400~600), 660(520~800) |

Compatibility bracket

- Mounting Metasol MC on Din-Rail of bracket after install the bracket on panel
- Please use compatibility bracket when replace from Meta-MEC to Metasol MC without to change of panel size

| | MP-40 | MP-85 |
|-----------------------|---|--|
| Manufactured products | MC-32a~40a | MC-50a~85a |
| Discontinued products | GMC-32~40 | GMC-50~85 |
| |  |  |









Certifications

| Type | | Type | Approvals | | | | | Certificates | |
|--|-----------|---|---|---|---|---|---|---|-------|
| | | Certificate | - | IEC | UL | CSA | GB | IEC | KEPIC |
| Mark and name | |  |  |  |  |  |  |  | |
| Type | | Korea | Europe | U.S.A & Canada | Canada | China | Denmark | Korea | |
| Metasol contactors | MC-6a | ● | ● | ● | ● | ● | ● | ● | |
| | MC-9a | ● | ● | ● | ● | ● | ● | ● | |
| | MC-12a | ● | ● | ● | ● | ● | ● | ● | |
| | MC-18a | ● | ● | ● | ● | ● | ● | ● | |
| | MC-9b | ● | ● | ● | ● | ● | ● | ● | |
| | MC-12b | ● | ● | ● | ● | ● | ● | ● | |
| | MC-18b | ● | ● | ● | ● | ● | ● | ● | |
| | MC-22b | ● | ● | ● | ● | ● | ● | ● | |
| | MC-32a | ● | ● | ● | ● | ● | ● | ● | |
| | MC-40a | ● | ● | ● | ● | ● | ● | ● | |
| | MC-50a | ● | ● | ● | ● | ● | ● | ● | |
| | MC-65a | ● | ● | ● | ● | ● | ● | ● | |
| | MC-75a | ● | ● | ● | ● | ● | ● | ● | |
| | MC-85a | ● | ● | ● | ● | ● | ● | ● | |
| | MC-100a | ● | ● | ● | ● | ● | ● | ● | |
| | MC-130a | ● | ● | ● | ● | ● | ● | ● | |
| | MC-150a | ● | ● | ● | ● | ● | ● | ● | |
| | MC-185a | ● | ● | ● | ● | ● | ● | ● | |
| | MC-225a | ● | ● | ● | ● | ● | ● | ● | |
| | MC-265a | ● | ● | ● | ● | ● | ● | ● | |
| | MC-330a | | ● | ● | ● | ● | ● | ● | |
| | MC-400a | | ● | ● | ● | ● | ● | ● | |
| | MC-500a | | ● | ● | ● | ● | ● | ● | |
| MC-630a | | ● | ● | ● | ● | ● | ● | | |
| MC-800a | | ● | ● | ● | ● | ● | ● | | |
| MC-1260a | | ● | ● | ● | | ● | ● | | |
| MC-1400a | | ● | ● | ● | | ● | ● | | |
| MC-1700a | | ● | ● | ● | | ● | ● | | |
| MC-2100a | | ● | ● | ● | | ● | ● | | |
| Thermal overload relays nondifferential (2-heater) | MT-12/2H | | ● | | | | ● | ● | |
| | MT-32/2H | | ● | ● | ● | | ● | ● | |
| | MT-63/2H | | ● | ● | ● | ● | ● | ● | |
| | MT-95/2H | | ● | ● | ● | ● | ● | ● | |
| | MT-150/2H | | ● | ● | ● | ● | ● | ● | |
| | MT-225/2H | | ● | ● | ● | ● | ● | ● | |
| | MT-400/2H | | ● | ● | ● | ● | ● | ● | |
| Thermal overload relays nondifferential (3-heater) | MT-800/2H | | ● | ● | ● | ● | ● | ● | |
| | MT-12/3H | | ● | ● | ● | ● | ● | ● | |
| | MT-32/3H | | ● | ● | ● | ● | ● | ● | |
| | MT-63/3H | | ● | ● | ● | ● | ● | ● | |
| | MT-95/3H | | ● | ● | ● | ● | ● | ● | |
| | MT-150/3H | | ● | ● | ● | ● | ● | ● | |
| | MT-225/3H | | ● | ● | ● | ● | ● | ● | |
| Thermal overload relays differential | MT-400/3H | | ● | ● | ● | ● | ● | ● | |
| | MT-800/3H | | ● | ● | ● | ● | ● | ● | |
| | MT-12/3K | | ● | ● | ● | ● | ● | ● | |
| | MT-32/3K | | ● | ● | ● | ● | ● | ● | |
| | MT-63/3K | | ● | ● | ● | ● | ● | ● | |
| | MT-95/3K | | ● | ● | ● | ● | ● | ● | |
| | MT-150/3K | | ● | ● | ● | ● | ● | ● | |
| Thermal overload relays class 20 | MT-225/3K | | ● | ● | ● | ● | ● | ● | |
| | MT-400/3K | | ● | ● | ● | ● | ● | ● | |
| | MT-800/3K | | ● | ● | ● | ● | ● | ● | |
| | MT-12/3D | | ● | ● | ● | ● | ● | ● | |
| | MT-32/3D | | ● | ● | ● | ● | ● | ● | |
| | MT-63/3D | | ● | ● | ● | ● | ● | ● | |
| | MT-95/3D | | ● | ● | ● | ● | ● | ● | |
| MT-150/3D | | ● | ● | ● | ● | ● | ● | | |
| MT-225/3D | | ● | ● | ● | ● | ● | ● | | |
| MT-400/3D | | ● | ● | ● | ● | ● | ● | | |
| MT-800/3D | | ● | ● | ● | ● | ● | ● | | |

Note) ●: Completion

Certifications

Marine

| Type | | Approvals | | | | | | | |
|--|---------------|---|---|---|---|--|---|---|---|
| Type | Mark and name |  |  |  |  |  |  |  |  |
| | | KR Korea | LR U.K | BV France | GL Germany | DNV Norway | ABS U.S.A | NK Japan | RINA Italy |
| Metasol contactors | MC-6a | ● | ● | ● | ● | ● | ● | ● | ● |
| | MC-9a | ● | ● | ● | ● | ● | ● | ● | ● |
| | MC-12a | ● | ● | ● | ● | ● | ● | ● | ● |
| | MC-18a | ● | ● | ● | ● | ● | ● | ● | ● |
| | MC-9b | ● | ● | ● | ● | ● | ● | ● | ● |
| | MC-12b | ● | ● | ● | ● | ● | ● | ● | ● |
| | MC-18b | ● | ● | ● | ● | ● | ● | ● | ● |
| | MC-22b | ● | ● | ● | ● | ● | ● | ● | ● |
| | MC-32a | ● | ● | ● | ● | ● | ● | ● | ● |
| | MC-40a | ● | ● | ● | ● | ● | ● | ● | ● |
| | MC-50a | ● | ● | ● | ● | ● | ● | ● | ● |
| | MC-65a | ● | ● | ● | ● | ● | ● | ● | ● |
| | MC-75a | ● | ● | ● | ● | ● | ● | ● | ● |
| | MC-85a | ● | ● | ● | ● | ● | ● | ● | ● |
| | MC-100a | ● | ● | ● | ● | ● | ● | ● | ● |
| | MC-130a | ● | ● | ● | ● | ● | ● | ● | ● |
| | MC-150a | ● | ● | ● | ● | ● | ● | ● | ● |
| | MC-185a | ● | ● | ● | ● | ● | ● | ● | ● |
| | MC-225a | ● | ● | ● | ● | ● | ● | ● | ● |
| | MC-265a | ● | ● | ● | ● | ● | ● | ● | ● |
| MC-330a | ● | ● | ● | ● | ● | ● | ● | ● | |
| MC-400a | ● | ● | ● | ● | ● | ● | ● | ● | |
| MC-500a | ● | ● | ● | ● | ● | ● | ● | ● | |
| MC-630a | ● | ● | ● | ● | ● | ● | ● | ● | |
| MC-800a | ● | ● | ● | ● | ● | ● | ● | ● | |
| Thermal overload relays nondifferential (2-heater) | MT-12/2H | ● | ● | ● | ● | ● | ● | ● | ● |
| | MT-32/2H | ● | ● | ● | ● | ● | ● | ● | ● |
| | MT-63/2H | ● | ● | ● | ● | ● | ● | ● | ● |
| | MT-95/2H | ● | ● | ● | ● | ● | ● | ● | ● |
| | MT-150/2H | ● | ● | ● | ● | ● | ● | ● | ● |
| | MT-225/2H | ● | ● | ● | ● | ● | ● | ● | ● |
| | MT-400/2H | ● | ● | ● | ● | ● | ● | ● | ● |
| MT-800/2H | ● | ● | ● | ● | ● | ● | ● | ● | |
| Thermal overload relays nondifferential (3-heater) | MT-12/3H | ● | ● | ● | ● | ● | ● | ● | ● |
| | MT-32/3H | ● | ● | ● | ● | ● | ● | ● | ● |
| | MT-63/3H | ● | ● | ● | ● | ● | ● | ● | ● |
| | MT-95/3H | ● | ● | ● | ● | ● | ● | ● | ● |
| | MT-150/3H | ● | ● | ● | ● | ● | ● | ● | ● |
| | MT-225/3H | ● | ● | ● | ● | ● | ● | ● | ● |
| | MT-400/3H | ● | ● | ● | ● | ● | ● | ● | ● |
| MT-800/3H | ● | ● | ● | ● | ● | ● | ● | ● | |
| Thermal overload relays differential | MT-12/3K | ● | ● | ● | ● | ● | ● | ● | ● |
| | MT-32/3K | ● | ● | ● | ● | ● | ● | ● | ● |
| | MT-63/3K | ● | ● | ● | ● | ● | ● | ● | ● |
| | MT-95/3K | ● | ● | ● | ● | ● | ● | ● | ● |
| | MT-150/3K | ● | ● | ● | ● | ● | ● | ● | ● |
| | MT-225/3K | ● | ● | ● | ● | ● | ● | ● | ● |
| | MT-400/3K | ● | ● | ● | ● | ● | ● | ● | ● |
| MT-800/3K | ● | ● | ● | ● | ● | ● | ● | ● | |
| Thermal overload relays class 20 | MT-12/3D | ● | ● | ● | ● | ● | ● | ● | ● |
| | MT-32/3D | ● | ● | ● | ● | ● | ● | ● | ● |
| | MT-63/3D | ● | ● | ● | ● | ● | ● | ● | ● |
| | MT-95/3D | ● | ● | ● | ● | ● | ● | ● | ● |
| | MT-150/3D | ● | ● | ● | ● | ● | ● | ● | ● |
| | MT-225/3D | ● | ● | ● | ● | ● | ● | ● | ● |
| | MT-400/3D | ● | ● | ● | ● | ● | ● | ● | ● |
| MT-800/3D | ● | ● | ● | ● | ● | ● | ● | ● | |

Note) ●: Completion

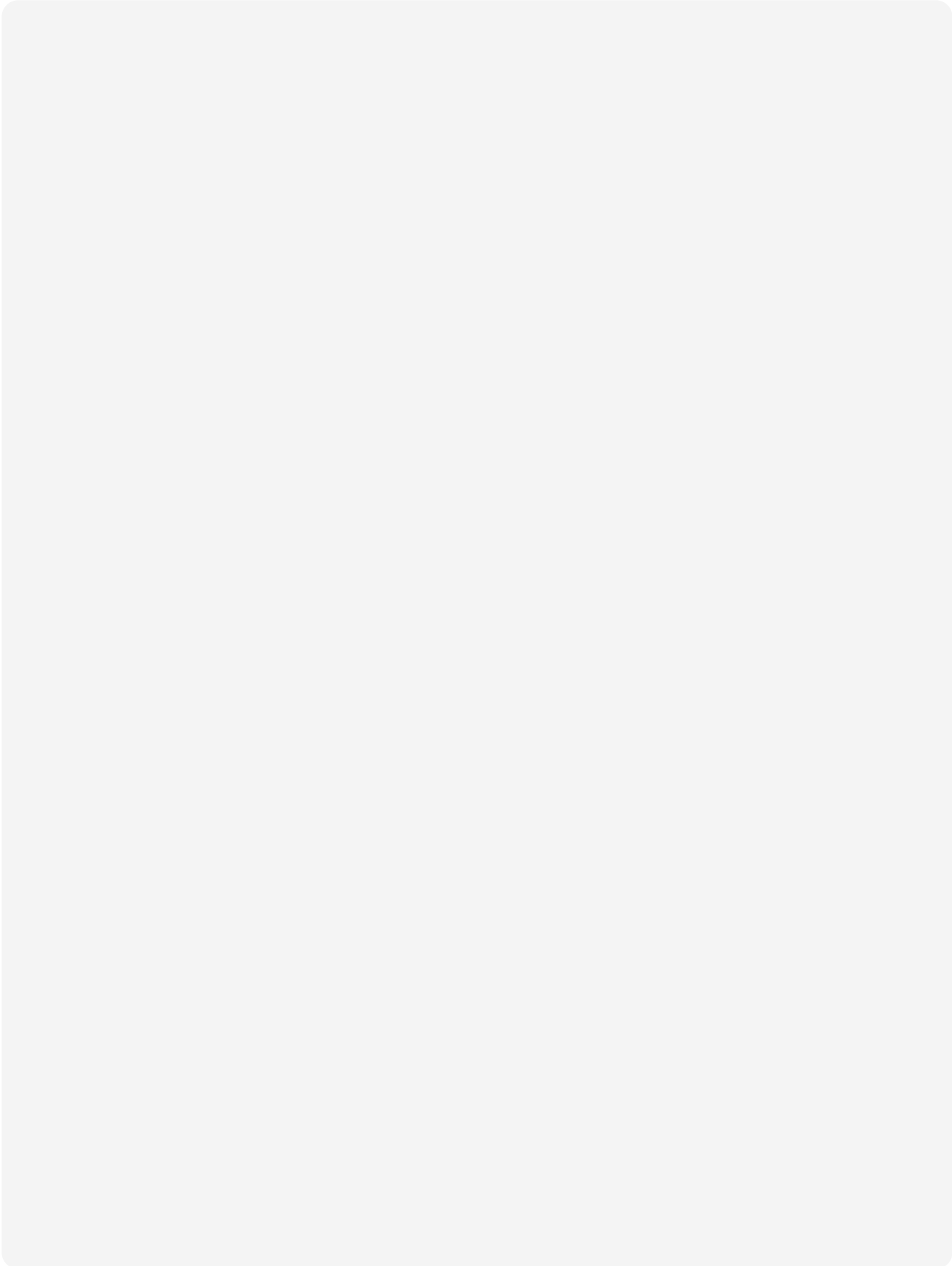



Safety Instructions

- For your safety, please read user's manual thoroughly before operating.
- Contact the nearest authorized service facility for examination, repair, or adjustment.
- Please contact qualified service technician when you need maintenance. Do not disassemble or repair by yourself!
- Any maintenance and inspection shall be performed by the personnel having expertise concerned.



- According to The WEEE Directive, please do not discard the device with your household waste.



www.ls-electric.com

■ **Headquarter**

LS-ro 127(Hogye-dong) Dongan-gu, Anyang-si, Gyeonggi-Do, 14119, Korea

■ **Seoul Office**

LS Yongsan Tower, 92, Hangang-daero, Yongsan-gu, Seoul, 04386, Korea
Tel: 82-2-2034-4916, 4684, 4429

■ **Overseas Subsidiaries**

- **LS ELECTRIC Japan Co., Ltd. (Tokyo, Japan)**
Tel: 81-3-6268-8241 E-Mail: japan@ls-electric.com
- **LS ELECTRIC (Dalian) Co., Ltd. (Dalian, China)**
Tel: 86-411-8730-5872 E-Mail: china.dalian@lselectric.com.cn
- **LS ELECTRIC (Wuxi) Co., Ltd. (Wuxi, China)**
Tel: 86-510-6851-6666 E-Mail: china.wuxi@lselectric.com.cn
- **LS ELECTRIC Vietnam Co., Ltd. (Hanoi, Vietnam)**
Tel: 84-222-22221-110 E-Mail: vietnam@ls-electric.com
- **LS ELECTRIC Middle East FZE (Dubai, U.A.E.)**
Tel: 971-4-886-5360 E-Mail: middleeast@ls-electric.com
- **LS ELECTRIC Europe B.V. (Hoofddorp, Netherlands)**
Tel: 31-20-654-1424 E-Mail: europartner@ls-electric.com
- **LS ELECTRIC America Inc. (Chicago, USA)**
Tel: 1-800-891-2941 E-Mail: sales.us@lselectricamerica.com
- **LS ENERGY Solutions LLC (Charlotte, USA)**
Tel: 1-704-587-4051 E-Mail: cmfeldman@ls-es.com
- **LS ELECTRIC Türkiye Co., Ltd. (Istanbul, Türkiye)**
Tel: 90-212-806-1252 E-Mail: turkiye@ls-electric.com
- **LS ELECTRIC IBERIA S.L.U. (Madrid, Spain)**
Tel: 34-910-28-02-74 E-Mail: iberia@ls-electric.com

■ **Overseas Branches**

- **LS ELECTRIC Tokyo Office (Japan)**
Tel: 81-3-6268-8241 E-Mail: tokyo@ls-electric.com
- **LS ELECTRIC Beijing Office (China)**
Tel: 86-10-5095-1631 E-Mail: china@lselectric.com.cn
- **LS ELECTRIC Shanghai Office (China)**
Tel: 86-21-5237-9977 E-Mail: china@lselectric.com.cn
- **LS ELECTRIC Guangzhou Office (China)**
Tel: 86-20-3818-2883 E-Mail: china@lselectric.com.cn
- **LS ELECTRIC Chengdu Office (China)**
Tel: 86-28-8670-3201 E-Mail: china@lselectric.com.cn
- **LS ELECTRIC Qingdao Office (China)**
Tel: 86-532-8501-2065 E-Mail: china@lselectric.com.cn
- **LS ELECTRIC Nanjing Office (China)**
Tel: 86-25-8467-0005 E-Mail: china@lselectric.com.cn
- **LS ELECTRIC Bangkok Office (Thailand)**
Tel: 66-90-950-9683 E-Mail: thailand@ls-electric.com
- **LS ELECTRIC Jakarta Office (Indonesia)**
Tel: 62-21-2933-7614 E-Mail: indonesia@ls-electric.com
- **LS ELECTRIC Moscow Office (Russia)**
Tel: 7-499-682-6130 E-Mail: info@lselectric-ru.com
- **LS ELECTRIC America Western Office (Irvine, USA)**
Tel: 1-949-333-3140 E-Mail: america@ls-electric.com
- **LS ELECTRIC India Office (India)**
Tel: 91-80-6142-9108 E-Mail: Info_india@ls-electric.com
- **LS ELECTRIC Singapore Office (Singapore)**
Tel: 65-6958-8162 E-Mail: singapore@ls-electric.com
- **LS ELECTRIC Italy office (Italy)**
Tel: 39-030-8081-833 E-Mail: italia@ls-electric.com