



DIN 35mm

## Features :

- 1Ø - 2 Wire, 3Ø - 4 Wire Input
- Monitors Under Voltage, Over Voltage, Phase Asymmetry, Phase Failure, Phase Sequence
- LED Indication : Power ON / Phase Failure, Under Voltage, Over Voltage, Phase Sequence / Asymmetry
- DIN Rail Mount
- Adjustable Over and Under Voltage Trip Level
- Adjustable Trip Time Delay

Certification : 

### Display Specifications

Type	Analog
No. of LED	4
No. of Knob	3

### LED Indication Chart

Condition	Power LED	Under Voltage LED	Over Voltage LED	Phase Reverse / Assymetry LED
Nominal Condition	ON	OFF	OFF	OFF
Under Voltage	ON	ON	OFF	OFF
Over Voltage	ON	OFF	ON	OFF
Phase Sequence	ON	OFF	OFF	ON
Phase Asymmetry	ON	OFF	OFF	Blink
Phase Failure (L2 / L3)	Blink	OFF	OFF	OFF

### Input Specifications

Functions	
Measurements	Under Voltage, Over Voltage, Phase Asymmetry, Phase Failure & Phase Sequence
Reset	Auto
Electrical Connection	1Ø - 2 wire, 3Ø - 4 wire
Trip Settings	
Under Voltage	55 to 95% of Un [127 to 219V AC (L - N)]
Over Voltage	105 to 125% of Un [242 to 288V AC (L - N)]
Phase Sequence	Yes
Phase Failure	Yes
Phase Asymmetry	>10%

### Trip Delay

Power On Delay	0 - 15sec (for 0 setting : <400msec)
Trip Time Delay	0 - 15sec (for 0 setting : <100msec)
Recovery Time Delay	5sec (Fixed) ±200ms
Phase Sequence Trip Delay	<250msec

### Hysteresis

Voltage	7V (±2V) of Trip setting
---------	--------------------------

### Accuracy

Trip Setting Accuracy	±5% of Full Scale
Time Setting Accuracy	±10% of Full Scale

### Output Specifications

Relay Contact	2 C/O (DPDT)
Relay Rating	5A@250V AC / 28V DC

### Auxiliary Supply Specifications

Nominal Input Voltage	230V AC (L-N)
Operating Voltage	127 to 288V AC (L-N)
Frequency	48 / 63Hz
Power Consumption	5VA max

### Environmental Specifications

Temperature	Operating Temperature : -10° to 55°C Storage Temperature : -25° to 70°C
Humidity (non-condensing)	Upto 95% RH
Pollution Degree	
For PCB	2
For Product	3
Degree of Protection Devices	IP20

### Mechanical Specifications

Mounting	DIN Rail
Weight	150 gms

### Dimensions

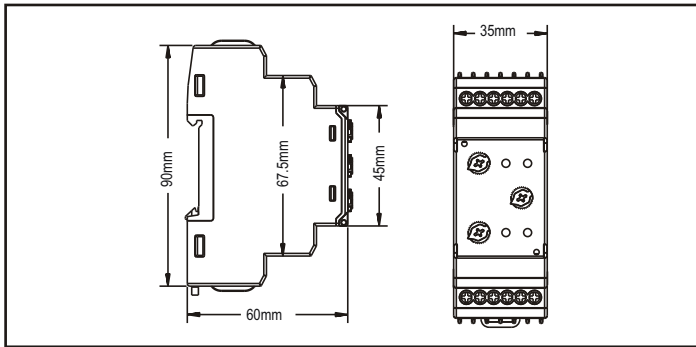

### Terminal Connection

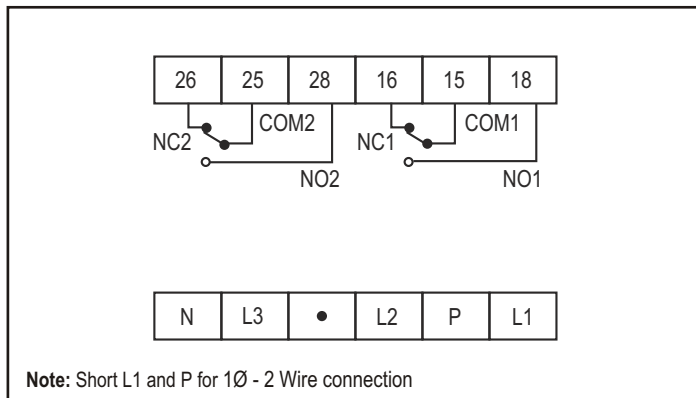

### Compliance

Applicable EMI / EMC Standards		
Product Standard : IEC 60947-2		
Category	Reference Standards	Testing Level
Electrostatic Discharge	IEC 61000-4-2	Level-3
Electrical Fast Transient / Burst	IEC 61000-4-4	Level-3
Electromagnetic Field	IEC 61000-4-3	Level-3
Surge	IEC 61000-4-5	Level-3
Conducted RF	IEC 61000-4-6	Level-2
Rated Power Frequency	IEC 61000-4-8	Level-4
Voltage Dip / Short Interruptions	IEC 61000-4-11	Level-3
Conducted Emissions	CISPR-11	Class-B
Radiated Emission	CISPR-22	Class-A
Emission & Immunity	IEC 61326-1	
Safety	IEC 61010-1	

### Ordering Information

Product Code	Operating Range	Certification
VPRA2M-CE	127 to 288V AC	CE

### Timing Diagram

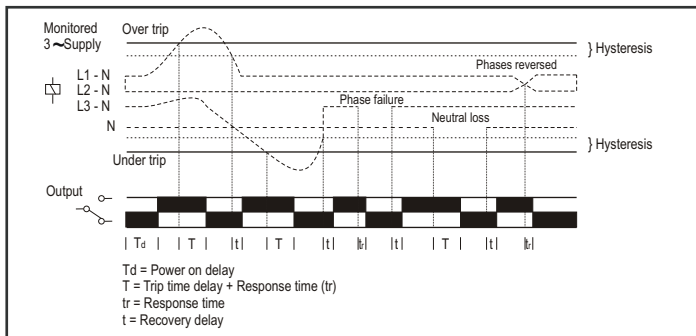

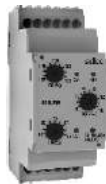

### FEATURES

- Under Voltage, Over Voltage, Phase Asymmetry, Phase sequence, Phase Failure and Neutral loss detection
- Adjustable over and under voltage trip level
- Adjustable operate time and trip time delay
- DPDT Relay Output (5A Resistive)
- Din Rail mounting

### SPECIFICATIONS

#### FUNCTION

Voltage and Phase controls

#### WIRING INPUT

1 Ø - 2 wire, 3 Ø - 4 wire

#### AUXILIARY

Self powered

#### Nominal Supply (Un)

230V AC (L-N)

#### OPERATING RANGE

127 - 288V AC (L-N)

#### FREQUENCY RANGE

48 - 63Hz

#### VA RATING

5VA

#### RESET

Auto

#### TRIP SETTING

Under Voltage : 55 to 95% of Un  
127 to 219V AC (L-N)

Over Voltage : 105 to 125% of Un  
242 to 288V AC (L-N)

Phase asymmetry : >10%

Setting accuracy : ± 5% of full scale ( Trip )  
± 10% of full scale ( Time )

#### TIME DELAY

Power ON Delay : 0 - 15 Sec  
For 0 setting : <400msec

Trip Time Delay : 0 - 15 Sec  
For 0 setting : <100msec

Recovery Time Delay : 5 Sec. ±200ms  
For L1 / Neutral loss Trip Delay : <200ms  
For Phase Sequence Trip Delay : <250ms

#### HYSTERISIS

7V ± 2V of trip Setting

#### OUTPUT SPECIFICATIONS

1 Relay : 2 C/O (DPDT)

#### RELAY RATING

5A (Res) @ 250V AC / 28V DC

#### LED INDICATION

- Green : Power ON
- Blink : L2 / L3 Phase Loss
- OV : Over Voltage
- UV : Under Voltage
- ON : Phase Reverse
- Blink : Phase asymmetry

#### ENVIRONMENTAL CONDITIONS

Temperature : Operating : - 10°C to 55°C  
Storage : - 25°C to 70°C

Humidity : Up to 95% non-condensing

#### MECHANICAL SPECIFICATIONS

Mounting : Din rail mounting  
Dimension : 35 x 90 x 60mm  
Enclosure : UL94V0

Screw tightening torque : 0.5 N·M

Degree of Protection

IP 20 for Terminal

IP 40 for Enclosure

IP 50 for Faceplate

#### WEIGHT

150gms

### SAFETY PRECAUTIONS

All safety related codifications, symbols and instructions that appear in this operating manual or on the equipment must be strictly followed to ensure the safety of the operating personnel as well as the instrument.

If there is physical damage to the unit then do not use it. Read complete instructions prior to installation of unit.

### WIRING GUIDELINES

#### WARNING :

1. To prevent the risk of electric shock, power supply to the equipment must be kept OFF while doing the wiring arrangement.
2. Wiring shall be done strictly according to the terminal layout. Confirm that all connections are correct.

#### CAUTION :

1. To ensure the safe operate of unit check wiring connection
2. It is recomm. to test the unit period to satisfy resolutions.

### MECHANICAL INSTALLATION

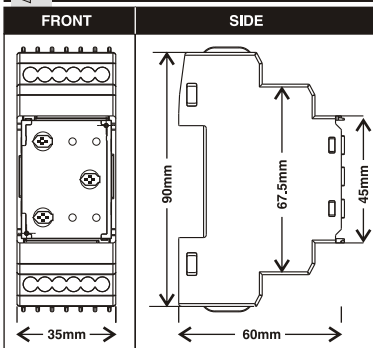

### TERMINAL CONNECTIONS

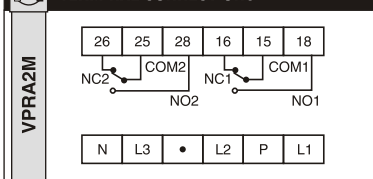

### LED INDICATION CHART

SUPPLY	POWER LED	UNDER VOLTAGE LED	OVER VOLTAGE LED	PHASE REVERSE / ASYMMETRY
NOMINAL CONDITION	ON	OFF	OFF	OFF
UNDER VOLTAGE	ON	ON	OFF	OFF
OVER VOLTAGE	ON	OFF	ON	OFF
PHASE REVERSED	ON	OFF	OFF	ON
PHASE ASYMMETRY	ON	OFF	OFF	BLINK
L2/L3 PHASE FAIL	BLINK	OFF	OFF	OFF

### OPERATING MODES

Product operates in single phase as well as three phase mode.

#### A) Single Phase Mode :

Connect R-Phase at L1, P and Neutral at N terminal. L2 and L3 connections are kept open. In single phase mode device monitors only L1 phase for OV and UV condition.

Single Phase Application

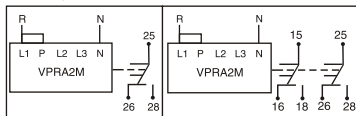

#### B) Three Phase Mode :

Connect three phase at L1, L2, L3 and Neutral at N terminal. Keep 'P' terminal open. Three Phase Application

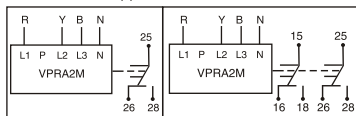

Fuse Protection on each Phase : 0.5A

### ORDER CODE INFORMATION

PRODUCT	CERTIFICATION	
	CE	RoHS
VPRA2M	—	—
VPRA2M-CE	■	■

(Specifications subject to change as development is a continuous process.)

### Selec Controls Pvt. Ltd., India

Factory Address :

EL-27/1, Electronic Zone, TTC Industrial Area, MIDC, Mahape, Navi Mumbai - 400 710, INDIA.

Tel. No. : +91-22-28476443 / 1882

Fax No. : +91-22-28471733 | Toll free : 1800 227 353

Website: www.selec.com | Email: sales@selec.com